



STATE OF ARKANSAS

PROFESSIONAL CONSULTANT SERVICES CONTRACT

CONTRACT #		FEDERAL I.D. #	
VENDOR #		MINORITY VENDOR	YES <input type="checkbox"/> NO <input checked="" type="checkbox"/>

1. PROCUREMENT:

Check ONE appropriate box below for the method of procurement for this contract:

- | | | | |
|---|---|---|---|
| <input type="checkbox"/> ABA Criteria | <input type="checkbox"/> Request for Proposal | <input type="checkbox"/> Competitive Bid | <input type="checkbox"/> Request for Qualifications |
| <input type="checkbox"/> Intergovernmental | <input type="checkbox"/> Emergency | <input type="checkbox"/> Invitation for Bid | <input type="checkbox"/> Cooperative Contract |
| <input type="checkbox"/> Sole Source by Justification <i>(Justification must be attached)</i> | | <input type="checkbox"/> Sole Source by Intent to Award | |
| <input type="checkbox"/> Sole Source by Law - Act # _____ | | or Statute #: _____ | |
| <input checked="" type="checkbox"/> Exempt by Law | | | |

2. TERM DATES:

The term of this agreement shall begin on 11/01/2015 and shall end on 06/30/2017.
(mm/dd/yyyy) (mm/dd/yyyy)

3. CONTRACTING PARTIES:

State of Arkansas is hereinafter referred to as the agency and contractor is herein after referred to as the Vendor.

AGENCY NUMBER & NAME	0023	Administrative Office of the Courts	<input type="checkbox"/> Service Bureau
VENDOR NAME	CSI Computing System Innovations		
VENDOR ADDRESS	791 Piedmont Wekiwa Rd, Apopka, FL 32703		
TRACKING # 1		TRACKING # 2	

4A. TOTAL PROJECTED CONTRACT COST:

Total Projected Cost of entire project if all available extensions of this contract are completed (up to the date anticipated and stated in Section 13)	\$	1,772,560.00
---	----	--------------

4B. CALCULATIONS OF COMPENSATION:

For work to be accomplished under this agreement, the Vendor agrees to provide the personnel at the rates scheduled for each level of consulting personnel as listed herein. Calculations of compensation and reimbursable expenses shall only be listed in this section. If additional space is required, a continuation sheet may be used as an attachment.

LEVEL OF PERSONNEL	NUMBER	COMPENSATION RATE	TOTAL FOR LEVEL
Integration Developers/Consultants	1	150.00	\$0.00

Total compensation exclusive of expense reimbursement \$ 1,772,560.00

REIMBURSABLE EXPENSES ITEM (Specify)	ESTIMATED RATE OF REIMB.	TOTAL
NA		

Total reimbursable expenses \$ 0.00

Total compensation inclusive of expense reimbursement \$ 1,772,560.00

**STATE OF ARKANSAS
PROFESSIONAL CONSULTANT SERVICES CONTRACT**

Contract #: _____

5. SOURCE OF FUNDS:

Complete appropriate box(es) below to total 100% of the funding in this contract. You may use an attachment if needed.

Fund Source	Identify Source of Funds*	Fund	Fund Center	Amount of Funding	% of Total Contract Cost
State Funds**	Supreme Court Appropriation	HSC3200	008P	\$ 11,500.00	0.65
Other Funds	Local Court Funds			\$ 1,761,060.00	99.35
				\$	
				\$	
				\$	
TOTALS				\$ 1,772,560.00	100%

* MUST BE SPECIFIC (i.e. fees, tuition, agricultural sales, bond proceeds, donations, etc.)

** "State Funds" is defined as and deemed State General Revenue Dollars. If other state funds are being used such as tobacco funds, general improvement funds, etc., these should be noted. Special revenue funds from taxes or fees generated for the agencies should be shown as "Other" and the actual source of the funds should be clarified in the "Identify Source of Funds."

6. RENDERING OF COMPENSATION:

The method(s) of rendering compensation and/or evaluation of satisfactory achievement toward attainment of the agreement listed herein is as follows, or in attachment no. _____ to this agreement.

Compensation will be made after verification and delivery to the court or AOC subject to vendor's cost proposal incorporated as paragraph 22 of the Agreement in Attachment 1. The estimate of the total contract price is based on per page options with vendor redaction and based on the current count of 15.7 million pages.

7. OBJECTIVES AND SCOPE:

State description of services, objectives, and scope to be provided. (DO NOT USE "SEE ATTACHED")

The AOC is deploying an electronic filing solution to Arkansas courts. Currently Arkansas courts are unable to make many public court documents available online to the public because they contain confidential information. The AOC issued an RFP for a commercial off-the-shelf document redaction solution available for statewide implementation in the courts of Arkansas. The solution will redact confidential information, including social security numbers, whether typed or handwritten and is capable of employing optical character recognition of scanned images, and storing the redacted file in a PDF format for delivery back to the court for public availability. The courts will be able to submit back files for redaction or engage the vendor for ongoing redaction of newly filed documents.

8. PERFORMANCE STANDARDS:

List Performance standards for the term of the contract. (If necessary, use attachments)

The vendor will provide redacted images at up to a 99.95% accuracy rate. The courts will be able to utilize either a completely automated redaction, an automated redaction with court-manual validation, or automated redaction with vendor validation. The accuracy rate is ensured by manually validating the redaction rules on a sample population of images prior to the production processing.

**STATE OF ARKANSAS
PROFESSIONAL CONSULTANT SERVICES CONTRACT**

Contract # : _____

9. ATTACHMENTS:

List ALL attachments to this contract by attachment number:

Attachment 1 - Contract with Exhibit-A Software Maintenance Agreement; Exhibit-B CSI Confidentiality Agreement
Exhibit-C AOC Request for Proposals; Exhibit-D CSI Proposal; Exhibit-E Statement of Work will be
incorporated for each court purchasing services under the contract

10. CERTIFICATION OF VENDOR

A. "I, Henry Sal _____ President _____
(Vendor) (Title)

certify under penalty of perjury that, to the best of my knowledge and belief, no regular full-time or part-time employee of any State agency of the State of Arkansas will receive any personal, direct or indirect monetary benefits which would be in violation of the law as a result of the execution of this contract." Where the Vendor is a widely-held public corporation, the term 'direct or indirect monetary benefits' "shall not apply to any regular corporate dividends paid to a stockholder of said corporation who is also a State employee and who owns less than ten percent (10%) of the total outstanding stock of the contracting corporation."

B. List any other contracts or subcontracts you have with any other state government entities. (Not applicable to contracts between Arkansas state agencies) (If no contracts or subcontracts, please put "N/A" or "None")

N/A

C. Are you currently engaged in any legal controversies with any state agencies or represent any clients engaged in any controversy with any Arkansas state agency? (If no controversies, please put "N/A" or "None")

N/A

D. The Vendor agrees to list below, or on an attachment hereto, names, addresses, and relationship of those persons who will be supplying services to the state agency at the time of the execution of the contract. If the names are not known at the time of the execution of the contract, the Vendor shall submit the names along with the other information as they become known. Such persons shall, for all purposes, be employees or independent contractors operating under the control of the Vendor (sub-contractors), and nothing herein shall be construed to create an employment relationship between the agencies and the persons listed below.

NAME	RELATIONSHIP
To Be Determined	

E. The agency shall exercise no managerial responsibilities over the Vendor or his employees. In carrying out this contract, it is expressly agreed that there is no employment relationship between the contracting parties.

11. DISCLOSURE REQUIRED BY EXECUTIVE ORDER 98-04:

Any contract or amendment to a contract executed by an agency which exceeds \$25,000 shall require the Vendor to disclose information as required under the terms of Executive Order 98-04 and the Regulations pursuant thereto. The Vendor shall also require the subcontractor to disclose the same information. The Contract and Grant Disclosure and Certification Form (Form PCS-D attachment II-10.3) shall be used for this purpose.

Contracts with another government entity such as a state agency, public education institution, federal government entity, or body of a local government are exempt from disclosure requirements.

The failure of any person or entity to disclose as required under any term of Executive Order 98-04, or the violation of any rule, regulation or policy promulgated by the Department of Finance and Administration pursuant to this Order, shall be considered a material breach of the terms of the contract, lease, purchase agreement, or grant and shall subject the party failing to disclose, or in violation, to all legal remedies available to the Agency under the provisions of existing law.

12. CANCELLATION CLAUSES

A. NON-APPROPRIATION CLAUSE PURSUANT TO §19-11-1012(11):

"In the event the State of Arkansas fails to appropriate funds or make monies available for any biennial period covered by the term of this contract for the services to be provided by the Vendor, this contract shall be terminated on the last day of the last biennial period for which funds were appropriated or monies made available for such purposes.

"This provision shall not be construed to abridge any other right of termination the agency may have."

B. CONVENIENCE CLAUSE:

In the event the State no longer needs the service or commodity specified in the contract or purchase order due to program changes, changes in laws, rules, or regulations, relocation of offices, the State may cancel the contract or purchase order by giving the vendor written notice of such cancellation 30 days prior to the date of cancellation.

13. TERMS:

The term of this agreement begins on the date in SECTION 2 and will end on the date in SECTION 2, and/or as agreed to separately in writing by both parties.

This contract may be extended until 06/30/2017 (mm/dd/yyyy), in accordance with the terms stated in the Procurement, by written mutual agreement of both parties and subject to: approval of the Arkansas Department of Finance and Administration/Director of Office of State Procurement, appropriation of necessary funding, and review by any necessary state or federal authority.

Contracts will require review by Legislative Council or Joint Budget Committee prior to the approval of the Department of Finance and Administration/Director of Office of State Procurement and before the execution date if the total initial contract amount or the total projected amount is greater than or equal to \$50,000, including any amendments or possible extensions.

Any amendment which increases the dollar amount or involves major changes in the objectives and scope of the contract will require review by Legislative Council or Joint Budget Committee.

14. AUTHORITY:

- A. This contract shall be governed by the Laws of the State of Arkansas as interpreted by the Attorney General of the State of Arkansas and shall be in accordance with the intent of Arkansas Code Annotated §19-11-1001 et seq.
- B. Any legislation that may be enacted subsequent to the date of this agreement, which may cause all or any part of the agreement to be in conflict with the laws of the State of Arkansas, will be given proper consideration if and when this contract is renewed or extended; the contract will be altered to comply with the then applicable laws.

**STATE OF ARKANSAS
PROFESSIONAL CONSULTANT SERVICES CONTRACT**

Contract # : _____

15. AGENCY CONTACTS FOR QUESTION(S) REGARDING THIS CONTRACT:

Contact #1 – Agency Representative submitting/tracking this contract

John Stewart _____ Deputy Director _____
(Name) (Title)
501-682-9400 _____ john.stewart@arcourts.gov _____
(Telephone #) (Email)

Contact #2 – Agency Representative with knowledge of this project (for general questions and responses)

Timothy N. Holthoff _____ CIS Division Director _____
(Name) (Title)
501-682-9400 _____ tim.holthoff@arcourts.gov _____
(Telephone #) (Email)

Contact #3 – Agency Representative Director or Critical Contact (for time sensitive questions and responses)

Lee Lowe _____ Senior Project Manager _____
(Name) (Title)
501-682-9400 _____ lee.lowe@arcourts.gov _____
(Telephone #) (Email)

16. AGENCY SIGNATURE CERTIFIES NO OBLIGATIONS WILL BE INCURRED BY A STATE AGENCY UNLESS SUFFICIENT FUNDS ARE AVAILABLE TO PAY THE OBLIGATIONS WHEN THEY BECOME DUE.

17. SIGNATURES:

 _____ 9/21/15
VENDOR DATE
President

TITLE

 _____ 9/18/15
AGENCY DIRECTOR DATE
Director

TITLE

791 Piedmont Wekiwa Rd, Apopka, FL 32703 _____
ADDRESS

625 Marshall Street, Justice Building, Little Rock, AR 72201 _____
ADDRESS

APPROVED: _____
DEPARTMENT OF FINANCE AND ADMINISTRATION DATE

CONTRACT AND GRANT DISCLOSURE AND CERTIFICATION FORM

Failure to complete all of the following information may result in a delay in obtaining a contract, lease, purchase agreement, or grant award with any Arkansas State Agency.

SUBCONTRACTOR: _____

SUBCONTRACTOR NAME: _____

Yes No

IS THIS FOR:

Goods?

Services? Both?

TAXPAYER ID NAME: Sal, Johnson & Associates, Inc. Goods? Services? Both?

YOUR LAST NAME: Skipper

FIRST NAME: Tammy

M.I.: L

ADDRESS: 791 Piedmont Wekiwa Road

STATE: FL

ZIP CODE: 32703

COUNTRY: USA

CITY: Apopka

AS A CONDITION OF OBTAINING, EXTENDING, AMENDING, OR RENEWING A CONTRACT, LEASE, PURCHASE AGREEMENT, OR GRANT AWARD WITH ANY ARKANSAS STATE AGENCY, THE FOLLOWING INFORMATION MUST BE DISCLOSED:

FOR INDIVIDUALS *

Indicate below if: you, your spouse or the brother, sister, parent, or child of you or your spouse is a current or former: member of the General Assembly, Constitutional Officer, State Board or Commission Member, or State Employee:

Position Held	Mark (✓)		Name of Position of Job Held [Senator, representative, name of board/ commission, data entry, etc.]	For How Long?		What is the person(s) name and how are they related to you? [i.e., Jane Q. Public, spouse, John Q. Public, Jr., child, etc.]	Relation
	Current	Former		From MM/YY	To MM/YY		
General Assembly							
Constitutional Officer							
State Board or Commission Member							
State Employee							

None of the above applies

FOR AN ENTITY (BUSINESS) *

Indicate below if any of the following persons, current or former, hold any position of control or hold any ownership interest of 10% or greater in the entity: member of the General Assembly, Constitutional Officer, State Board or Commission Member, State Employee, or the spouse, brother, sister, parent, or child of a member of the General Assembly, Constitutional Officer, State Board or Commission Member, or State Employee. Position of control means the power to direct the purchasing policies or influence the management of the entity.

Position Held	Mark (✓)		Name of Position of Job Held [Senator, representative, name of board/commission, data entry, etc.]	For How Long?		What is the person(s) name and what is his/her % of ownership interest and/or what is his/her position of control?	Ownership Interest (%)	Position of Control
	Current	Former		From MM/YY	To MM/YY			
General Assembly								
Constitutional Officer								
State Board or Commission Member								
State Employee								

None of the above applies

Contract and Grant Disclosure and Certification Form

Failure to make any disclosure required by Governor's Executive Order 98-04, or any violation of any rule, regulation, or policy adopted pursuant to that Order, shall be a material breach of the terms of this contract. Any contractor, whether an individual or entity, who fails to make the required disclosure or who violates any rule, regulation, or policy shall be subject to all legal remedies available to the agency.

As an additional condition of obtaining, extending, amending, or renewing a contract with a state agency I agree as follows:

1. Prior to entering into any agreement with any subcontractor, prior or subsequent to the contract date, I will require the subcontractor to complete a CONTRACT AND GRANT DISCLOSURE AND CERTIFICATION FORM. Subcontractor shall mean any person or entity with whom I enter an agreement whereby I assign or otherwise delegate to the person or entity, for consideration, all, or any part, of the performance required of me under the terms of my contract with the state agency.
2. I will include the following language as a part of any agreement with a subcontractor:

Failure to make any disclosure required by Governor's Executive Order 98-04, or any violation of any rule, regulation, or policy adopted pursuant to that Order, shall be a material breach of the terms of this subcontract. The party who fails to make the required disclosure or who violates any rule, regulation, or policy shall be subject to all legal remedies available to the contractor.
3. No later than ten (10) days after entering into any agreement with a subcontractor, whether prior or subsequent to the contract date, I will mail a copy of the CONTRACT AND GRANT DISCLOSURE AND CERTIFICATION FORM completed by the subcontractor and a statement containing the dollar amount of the subcontract to the state agency.

I certify under penalty of perjury, to the best of my knowledge and belief, all of the above information is true and correct and that I agree to the subcontractor disclosure conditions stated herein.

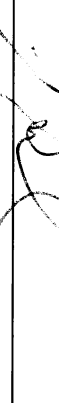
Signature  _____ Title President _____ Date 09/10/2015 _____

Vendor Contact Person Tammy L. Skipper _____ Title Office Manager _____ Phone No. 407-598-1803 _____

Agency use only			
Agency Number _____	Agency Name _____	Agency Contact Person _____	Contact Phone No. _____ or Grant No. _____

Master Services Agreement

This Master Services Agreement ("Agreement") is made and entered into as of the latest date on which the Agreement is executed by both Parties and approved by the Arkansas Legislative Council (the "Effective Date") by and between Sal, Johnson & Associates, Inc. d/b/a Computing System Innovations ("CSI") and Arkansas Supreme Court, Administrative Office of the Courts ("Customer") for the benefit of the courts of the State of Arkansas ("Court"). Each particular Court shall become a party to this Agreement upon execution of their applicable Statement of Work.

Pursuant to this Agreement, the Parties intend to:

- (a) create a contracting vehicle pursuant to which CSI and the Courts, or CSI, Customer, and the Courts, if Customer is providing an impacted service to the Court, can enter into agreements for licenses and services from time to time; and
- (b) establish the terms by which immediate needs for services from CSI can be provided to the Customer or Court.

In consideration of the mutual promises contained herein, CSI and the Customer agree as follows:

1. DEFINITIONS

- 1.1 Agreement means this Master Services Agreement, along with the Exhibits attached hereto, which are incorporated by reference, and any appendixes or attachments not attached hereto, but associated with the Agreement.
- 1.2 Authorization Confirmation means an Authorization Order that has been approved in writing as set forth in Section 5.3.
- 1.3 Authorization Order means a signed, written order submitted by CSI to the Court identifying specific CSI services required pursuant to this Agreement and requesting authorization to allocate and incur the number of hours set forth therein to perform such services in accordance with the Implementation Plan.
- 1.4 Business Day means any day, Monday through Friday, excepting any day that is a federal holiday.
- 1.5 Change means a change, amendment, or modification to a Statement of Work, Specifications, Conceptual Product Design (CPD) Document, Implementation Plan, or other Deliverable that affects the Contract Price.
- 1.6 Change Confirmation means a Change Order that has been approved in writing as set forth in Section 5.4.
- 1.7 Change Order means a signed, written order submitted by CSI to the Court or Customer requesting any Change.
- 1.8 Claims mean any and all claims, liens, demands, damages, liability, actions, causes of action, losses, judgments, costs, and expenses, excluding attorneys' fees and expenses.
- 1.9 Court means any appellate, circuit, or district court of the State of Arkansas and its political subdivisions that acquires software or services under this Agreement through execution of a Statement of Work.
- 1.10 Customer means Arkansas Supreme Court, Administrative Office of the Courts.
- 1.11 Customer or Court Modifications has the meaning set forth in Section 11.2.
- 1.12 Contract Price means the cost of each engagement as detailed in a CSI provided Statement of Work for each project.
- 1.13 Conceptual Product Design (CPD) Document means a high level description and illustration of the business processing in sufficient detail for both CSI and Customer to understand the nature of the services to be performed and/or product to be created.
- 1.14 Confidential Information means, with respect to CSI, confidential and/or proprietary information of CSI or its vendors which is disclosed by CSI to the Customer or Court, including but not limited to any and all CSI Trade Secrets and CSI Software including any source codes, object codes, executable codes, databases, database schemas, software systems, software architecture, related Documentation, UML diagrams, user interface design and functionality, user interface look and feel (excluding Customer or Court data displayed), user processing workflows, financial data, marketing or business plans, and other business information and/or material of CSI, which is marked or otherwise identified to the Customer or Court as confidential, or which should reasonably be understood to be confidential and/or proprietary whether disclosed prior to or after the date of this Agreement and whether disclosed orally, electronically, or in writing, and, with respect to Customer or Court, means any and all information which Customer or Court is mandated, by law, court order, rule or policy, to hold in confidence, such as financial and bank account data (collectively, "Confidential Information"). Notwithstanding the foregoing, in each case, Confidential Information does not include information that: (a) becomes public other than as a result of a disclosure by the receiving party in breach hereof; (b) becomes available to the receiving party on a non-confidential basis from a source other than the disclosing party, which is not prohibited from disclosing such information by obligation to the disclosing party; (c) is known by the receiving party as shown through written records or in the public domain prior to its receipt from the disclosing party without any obligation of confidentiality with respect thereto; or (d) is developed by the receiving party independently of any disclosures made by the disclosing party and without any use of the disclosing party's Confidential Information.
- 1.15 Critical Defect has the meaning set forth in **Exhibit A** – Software Maintenance Agreement

- 1.16 CSI means Sal & Associates, Inc. d/b/a Computing System Innovations, a Florida corporation.
- 1.17 CSI Confidentiality Agreement means the form of confidentiality agreement to be executed by contractors, subcontractors, or other third parties employed or engaged by the Customer or Court prior to such parties being permitted access to CSI Confidential Information or CSI Trade Secrets, which is attached hereto as **Exhibit B**.
- 1.18 CSI Trade Secrets means all methodologies and other CSI Confidential Information that constitutes a trade secret under applicable law.
- 1.19 CSI Modifications has the meaning set forth in Section 11.1.
- 1.20 CSI Software means: (a) software or deliverables provided by CSI to Customer or Court that are reflected on executed Statements of Work; (b) applicable Embedded Third Party Software; (c) CSI Modifications; and (d) any Enhancement to such software.
- 1.21 Defect means any bug, inaccuracy, error, contaminate, malfunction, or other defect in the CSI Software caused by, arising from, or emanating from the reasonable control of CSI that renders the CSI Software, work performed and/or service provided by CSI to Customer or Court in non-conformance with the Specifications or the terms of this Agreement.
- 1.22 Deliverable means any CSI Software or other deliverable required to be delivered by CSI to Customer or Court pursuant to this Agreement.
- 1.23 Documentation means the user's operating manuals and any other materials in any form or media provided by CSI to the Customer or Court.
- 1.24 Effective Date means the date set forth in the first paragraph of the Agreement.
- 1.25 Embedded Third Party Software means licensed third party software (other than Third Person Software) that is required to provide the functionality of the CSI Software as set forth in the Specifications and is provided by CSI along with CSI Software.
- 1.26 Enhancement(s) means a change or addition to the CSI Software or service, other than a Defect correction, that (i) improves the function of, (ii) adds a new function to or (iii) substantially enhances the performance of the CSI Software, or service, provided that Enhancements shall not include any improvements or new functions, in any form, that have additional value or utility, and may be priced and offered separately from the CSI Software or service.
- 1.27 Executive Dispute Level has the meaning set forth in Section 20.
- 1.28 Final Acceptance has the meaning set forth in Section 8.2.
- 1.29 Implementation Plan means the implementation plan set forth in a Statement of Work which provides for the timetables, milestones, and fees and expenses for, among other things, (a) the delivery and installation of CSI Software to the Customer or Court, and (b) the training of Customer or Court personnel, all in accordance with the terms of this Agreement.
- 1.30 Indemnified Parties mean CSI or the Customer or Court, as the case may be, and each of its personnel, agents, successors, and assigns.
- 1.31 Intermediary Dispute Level has the meaning set forth in Section 20.
- 1.32 License Fee means the fees as set forth in each Quotation and/or Statement of Work provided by CSI which is due and payable to CSI as set forth in Section 4.1.
- 1.33 Licensed Property means the CSI Software and the Documentation.
- 1.34 Customer Maintenance and Support Fees has the meaning set forth in **Exhibit A** – Software Maintenance Agreement.
- 1.35 Non-Critical Defect has the meaning set forth in **Exhibit A** – Software Maintenance Agreement.
- 1.36 Party means either Customer or Court or CSI.
- 1.37 Project means the delivery and license of the Licensed Property or other Deliverables and the performance of all services to be provided by CSI in accordance with the provisions of this Agreement.
- 1.38 Project Personnel has the meaning set forth in Section 2.5.
- 1.39 Project Manager means the person designated by each Party who is responsible for the management and implementation of this Agreement as more fully described in Section 2.2.
- 1.40 Project Signatory means the person designated by each Party who has authority to negotiate Change Orders and execute Change Confirmations as more fully described in Section 2.2.

1.41 Quotation means the costs, fees or expenses, including any License Fees or Maintenance and Support Fees, associated with any licensed CSI Software or services to be performed by CSI as detailed in an associated Statement of Work.

1.42 Software Maintenance Agreement means the maintenance and support services agreement for the CSI Software, which is attached hereto as Exhibit A.

1.43 Specifications means the information, functions, capabilities, requirements, and other specifications of the CSI Software, as provided for in an executed Statement of Work.

1.44 T&M means time and materials.

1.45 Statement of Work shall mean an attached Exhibit to this Agreement, executed by all parties, which shall set forth (a) the services, if any, to be provided; (b) the CSI Software to be licensed; (c) the support to be provided for the deliverables of such services or the CSI Software licensed; (d) milestones and deliverables and (e) the total costs and the payment schedule, including milestone payments where applicable, as well as such other terms as the Parties may agree to with respect to a Project, as further described in Section 5.1.

1.46 Term has the meaning set forth in Section 19.1.

1.47 Third Person Hardware means the CPUs, servers, and other hardware to be leased, purchased, or otherwise acquired by the Customer or Court from a third party that is minimally required to operate the CSI Software and such other CPUs, servers, and other hardware that the Customer or Court has actually leased, purchased or otherwise acquired and/or may be minimally required in the future to operate the CSI Software.

1.48 Third Person Software means the operating systems and other software to be licensed, purchased, or otherwise acquired by the Customer or Court from a third party that is minimally required to operate the CSI Software and such operating systems and other software that the Customer or Court has actually licensed, purchased, or otherwise acquired and/or may be minimally required in the future to operate the CSI Software.

1.49 Verification Procedure has the meaning set forth in Section 7.1.

1.50 Version Release has the meaning set forth in Section 11.1

2. SERVICES FRAMEWORK

2.1 Services Framework. As of the Effective Date, this Agreement sets forth the terms whereby CSI shall provide to the Customer or Court, and the Customer or Court shall acquire from CSI, the following, as set forth and identified on one or more Statements of Work (and each on the terms and subject to the conditions of this Agreement): (a) a license for the Licensed Property for the License Fee; (b) certain implementation, installation, testing, and training services related to the CSI Software; and (c) certain optional developmental services with respect to Enhancements to the CSI Software or service.

2.2 Project Management. CSI and the Customer or Court shall designate and cause the employees identified within the Exhibit(s) or other qualified employees designated to replace such employee in accordance with this Agreement, subject to approval and acceptance in writing prior to replacement) to serve as:

a Party's Project Manager, who shall manage and implement the Party's respective obligations pursuant to this Agreement and serve as the primary contact for the respective Party. The Party's Project Manager is and shall be qualified and authorized to perform the tasks assigned and shall have the authority to negotiate the details of the Statements of Work and Changes Orders:

b Party's Project Signatory, who shall have the authority to negotiate the details of Statements of Work and Change Orders, and execute Statements of Work and Change Confirmations.

c Each Party represents that its respective Project Manager and Project Signatory is and shall be qualified and authorized to perform the tasks assigned to him/her as defined in (a) and (b) above; and any written execution by Party's Signatory shall be binding on the respective Party.

2.3 Cooperation. The Customer or Court shall provide such reasonable information regarding its operations and reasonable access to its facilities (including, providing CSI reasonable access to a secure virtual private network connection or other comparable connection for use by CSI from time to time on a non-dedicated basis) and personnel in order for CSI to fulfill its obligations pursuant to this Agreement. The Customer or Court shall also provide CSI with periodic copies of CSI's production databases that CSI will use to perform testing of CSI Software at CSI's facilities. To the extent the Statement of Work and/or Implementation Plan includes any deadlines, services, and/or Deliverables that shall be determined at a time after the Effective Date, each Party shall negotiate in good faith to establish such deadlines and/or Deliverables at a reasonable time so as not to unreasonably interrupt the other deadlines of the Implementation Plan.

2.4 Responsibilities of Customer or Court. In addition to the other responsibilities set forth herein and as may be set forth in a Statement of Work or the Maintenance and Support Agreement, and except as otherwise specifically set forth in this Agreement, the Customer or Court shall:

a provide training of its personnel in addition to the training to be provided by CSI as detailed in Exhibit(s) or a Statement of Work. This additional Customer or Court training shall include remedial training and training of new employees for which CSI has trained the trainers;

- b collect, prepare, and enter all data necessary for the day-to-day operations of the CSI Software;
- c retain separate copies of all conversion data delivered to CSI;
- d provide the computer system on which the CSI Software will be loaded and operated;
- e provide the requisite networks;
- f maintain an internal help desk function;
- g prior to Project completion, install all changes or updates into the CSI Software and Third Person Software products that are furnished by CSI for the purpose of correcting failures of the CSI Software to conform to, and perform in accordance with, the requirements of this Agreement; and
- h provide, as part of the Customer's or Court's computer system, a secure VPN connection as needed for use by CSI.

2.5 Project Personnel. CSI represents and warrants that all personnel it uses in connection with fulfilling its obligations pursuant to or arising from this Agreement (the "Project Personnel") shall be employees of CSI or, if applicable, CSI's subcontractor(s), shall be qualified to perform the tasks assigned them, and shall be in compliance with all applicable laws relating to employees generally, including, without limitation, immigration laws. CSI shall not utilize any subcontractor(s) without the prior written consent of the Customer or Court Project Manager, which consent shall not be unreasonably withheld. The approval by the Customer or Court of CSI's right to use subcontractor(s) shall not waive or relieve CSI from CSI's obligations pursuant to this Agreement. CSI shall be solely responsible for the payment of all wages, benefits, worker's compensation, disability benefits, unemployment insurance, as well as for withholding any required taxes, for all Project Personnel in accordance with applicable federal, state, and local law.

2.6 Termination of Project Personnel. The Customer or Court may, upon written notice to the CSI Project Manager, require CSI to remove an individual immediately from the Project for the following reasons:

- i material violation of the terms and conditions of this Agreement;
 - ii material violation of the Customer's or Court's written work rules and regulations as disclosed in writing to CSI;
 - iii criminal activity; or
 - iv violation of state, federal, or municipal law.
- b CSI may reasonably extend any deadlines adversely affected by any delays in the Implementation Plan directly attributable to the Customer's or Court's request for the removal of CSI personnel, and CSI shall not be responsible for such delays in the Implementation Plan.
- c Background Checks. CSI shall conduct background checks on all key CSI project personnel to be specifically assigned to Customer's or Court's implementation and/or CSI personnel who may be physically onsite at Customer's or Court's office(s).
- d Security. CSI personnel will comply with all reasonable security requirements relating to access to Customer's or Court's office and site locations. CSI shall ensure that reasonable and appropriate security protocols are in place related to handling and treatment of Customer or Court Confidential Information applicable to all CSI employees having access to Customer or Court Confidential Information.

3. TITLE AND LICENSE

3.1 License Grant. CSI hereby grants to the Customer and Courts a non-exclusive, non-sublicensable, non-transferable, revocable license (and sublicense with respect to the Embedded Third Party Software) to use the Licensed Property for the Customer's or Court's internal administration, operation, and/or conduct of the Customer's or Court's business intended for CSI Software as described in the executed Statement's of Work. The foregoing license is revocable by CSI only after this Agreement is terminated in accordance with the provisions herein or the Customer or Court does not pay the License Fee in full. The forgoing license includes the right for Customer or Court to integrate the Licensed Property with Third Person Software only, provided, however, that CSI makes no representations or warranties with respect to such Third Person Software, except as explicitly stated in Section 14.18. The Licensed Property is licensed and not sold to Customer or Court. As between Customer or Court on one hand and CSI on the other, all right, title, and interest in and to the Licensed Property and any improvements, modifications, customizations (unless otherwise agreed to in a Statement of Work), Enhancement, or update thereto (now or hereafter resulting from the efforts of CSI, Customer, Court, or any other person, working together or alone) and all associated intellectual property rights shall at all times remain the sole and exclusive property of CSI. Customer and Courts hereby disclaim any right, title, or interest in or to the Licensed Property, and agree not to take any action inconsistent with or that would contest or impair the rights of CSI in or to such Licensed Property.

3.2 Restrictions. Unless otherwise expressly set forth in this Agreement or otherwise agreed in writing by CSI the Customer and Court shall not::

- a reverse engineer, de-compile, or disassemble any portion of the CSI Software. CSI Trade Secrets, or CSI Confidential Information

- b intercept and reverse engineer, de-compile, or disassemble any CSI Software programmatic transactions, including but not limited to SOAP, REST, HTTP, or SQL transactions;
- c add, change, delete data contained in any CSI Software databases without use of CSI Software application programming interfaces or CSI Software user interfaces;
- d sublicense, transfer, rent, lease, time-share, or otherwise transfer, or operate a service bureau using, the Licensed Property, whether as a standalone or bundled product, for any reason, and any attempt to make any such sublicense, assignment, delegation, rent, lease, sale, time-share, or other transfer by Customer or Courts shall be void and of no effect;.
- e make copies of the Licensed Property except as provided herein;
- f modify, translate, or create derivative works of the Licensed Property without the prior written consent of CSI, which may be withheld in CSI's sole discretion;
- g remove any copyright, trademark, patent, or other proprietary notice that appears on the Licensed Property or copies thereof, or
- h allow access to the Licensed Property beyond the scope of the license grant in Section 3.1

Customer and Court shall inform its employees about the restrictions contained herein and Customer and Court shall ensure that its employees agree to and strictly abide by the terms herein. Customer and Court hereby accepts full responsibility for any violations of the terms herein by such employees or any contractors, subcontractors, or other third parties engaged to assist in the Project. To the extent the Customer or Court engages contractors, subcontractors, or other third parties to assist in the Project to integrate or interface the Licensed Property with Third Person Software, the Customer or Court shall obtain from such third parties an executed CSI Confidentiality Agreement in the form attached hereto as **Exhibit B** prior to such parties being permitted access to CSI Software, CSI Confidential Information, and/or CSI Trade Secrets. Customer and Court agrees that it shall not allow anyone access to the foregoing items for any other purpose whatsoever.

3.3 Copies. The Customer and Courts may make and maintain such copies of the Licensed Property as are reasonably appropriate for its use of the Licensed Property and for archival and backup purposes; provided, however, that Customer or Court shall retain all proprietary notices, logos, copyright notices, and similar markings on such copies.

3.4 Embedded Third Party Software. The license grant set forth in Section 3.1 includes the right to use any Embedded Third Party Software. Access to and use of such Embedded Third Party Software shall be according to the terms, conditions, and licenses imposed by the manufacturers and/or third party licensors of such Embedded Third Party Software. All such Embedded Third Party Software shall be included in the License Fee. To the extent legally possible, CSI shall pass through to the Customer and Courts any and all warranties granted to CSI by the owners, licensors, and/or distributors of such Embedded Third Party Software. The Customer or Court shall be responsible for procuring and paying for all Third Person Software which is not embedded.

3.5 Title.

a CSI represents and warrants that it is the owner of all right, title, and interest in and to the CSI Software (other than Embedded Third Party Software) and all components and copies thereof. Nothing in this Agreement shall be deemed to vest in the Customer or Courts any ownership or intellectual property rights in and to CSI's intellectual property (including, without limitation, CSI Confidential Information and CSI Trade Secrets), any components and copies thereof, or any derivative works based thereon prepared by CSI. All ownership and proprietary rights in such items are hereby exclusively retained by CSI.

b All training materials developed solely by either Party shall be the sole property of such Party. Any training materials developed jointly by the Parties shall be owned jointly by the Parties, and each Party shall be entitled to exercise all rights of ownership of such materials without any duty to account to the other, subject to Section 14.

c All Customer and Court data (including, without limitation, all content in any media or format entered into, stored in, and/or susceptible to retrieval from the Customer's or Court's computer systems) shall remain the exclusive property of the Customer or Court. CSI shall not use the Customer or Court data other than in connection with providing the services pursuant to this Agreement. CSI shall comply with reasonable written security procedures that are in effect during the Term of this Agreement for the security of the Customer's or Court's facilities and the Customer's or Court's data to the extent such written procedures are provided to CSI.

3.6 License Fee. In consideration for the license granted to the Customer and Courts herein for internal use of the Licensed Property, the Customer or Court shall pay to CSI the License Fee, which shall be due and payable in accordance with the provisions of Section 4.

4. FEES AND INVOICING

4.1 License Fee. The Customer or Court shall pay to CSI the License Fees as set forth in Statements of Work and which, upon execution, are subject to the terms and conditions of this Master Service Agreement. CSI shall invoice the Customer or Court upon each Invoice Event directly related to identified milestones within each Statement of Work, which shall be paid in accordance with Section 4.4.

4.2 Services. Charges for all services to be performed hereunder shall be invoiced and paid by the Customer or Court as set forth in the Statements of Work in accordance with Section 4.4.

4.3 Expenses. Customer or Court will be invoiced for actual expenses of travel subject to any statutory reimbursement limitations imposed on Customer or Court contractors, including, without limitation, as applicable, mileage, airfare, meals, lodging, and similar expenses for reimbursement. Customer shall pre-approve any such CSI travel expenses.

4.4 Invoice and Payment. CSI shall invoice the Customer or Court for services and associated expenses herein in accordance with the milestones and Deliverables within each Statement of Work. Each invoice shall state the total invoiced amount and shall be accompanied by a reasonably detailed itemization of services and expenses. Following receipt of a properly submitted invoice, the Customer or Court shall pay amounts owing therein within thirty (30) days from the invoice date. All payments shall be made in U.S. currency. In the event payment is not made as specified in this Agreement, the Customer or Court shall pay interest at the rate of one and one-half percent (1.5%) per month (or the highest applicable legal rate, whichever is lower) on the outstanding overdue balance for each month or part thereof that such sum is overdue; *provided, however*, that if the Customer or Court is a governmental agency or authority subject to a "prompt payment" or similar statutory requirement for the transaction contemplated in this Agreement, such statutory requirement shall control to the extent the same is inconsistent with the requirements of this Section 4.4.

5. SERVICES IMPLEMENTATION

5.1 Statements of Work. Each Statement of Work contains the Implementation Plan for each project, which includes the milestones and timetables required for the completion of the tasks set forth therein. CSI shall bill, and the Customer or Court agrees to pay CSI, for the costs incurred in preparing any Statement of Work on a T&M basis at the rates detailed in an applicable Quotation provided by CSI and approved by the Customer or Court prior to the commencement of preparing a Statement of Work. The responsibilities of the Parties set forth herein at times require the Parties to meet and jointly agree on certain matters. To the extent the Parties are required to meet and negotiate Statements of Work and certain addenda to this Agreement or other things that could affect the Implementation Plan in Statements of Work, the Parties agree to work together in good faith so as not to unnecessarily alter the timetables set forth in the Implementation Plan. Each Party shall perform its obligations pursuant to this Agreement in accordance to a Statement of Work and such timetables, subject to any Change Confirmations. The execution of the Implementation Plan detailed within a Statement of Work shall be subject to Authorization Orders, Authorization Confirmations, Change Orders, and Change Confirmations as set forth in this Section 5.

5.2 Quotations. Prior to the execution of a Statement of Work, CSI shall prepare and issue a Quotation for review and approval by the Customer or Court.

5.3 Authorization Orders. From time to time, the Customer, Court, or CSI may discuss, request, and/or recommend specific changes to a Statement of Work that do not affect the overall price associated with each individual Statement of Work but may affect the overall implementation timeline. Promptly, but in no event longer than ten (10) Business Days, after any request or recommendation for such change, CSI shall submit a respective Authorization Order to the Customer for review identifying the nature of the change to the Statement of Work. The Customer or Court shall use its good faith efforts to either approve or disapprove any Authorization Order in a signed writing (any approved Authorization Order being a "Authorization Confirmation(s)") within five (5) Business Days (or other period as reasonably requested by the Client, as applicable, in writing); *provided, however*, that any Authorization Order not expressly approved in a signed writing by the Customer or Court within such time period shall be deemed approved.

5.4 Change Orders. From time to time, the Customer, or Court, or CSI may discuss, request, and/or recommend a Change to an executed Statement of Work. Promptly, but in no event more than ten (10) Business Days after any request or recommendation for a Change, CSI shall submit a respective Change Order to the Customer or Court for review identifying, at a minimum:

- a the nature of the Change;
- b CSI's quote for the additional cost, if any, of implementing the Change Order;
- c the timetable for implementing the Change Order; and
- d the effect, if any, of the Change Order on the anticipated implementation schedule.

e Unless otherwise provided in any applicable project plan or written correspondence between the parties, the Customer or Court shall use its good faith efforts to either approve or disapprove any Change Order within ten (10) Business Days; *provided, however*, that any Change Order not expressly approved in writing by the Customer within such time period shall be deemed disapproved. No such Change Order shall be effective unless the Customer or Court Project Manager approves the Change Order in a signed writing ("Change Confirmation"). Any Change Confirmation shall constitute a formal amendment to original Statement of Work and the specific Implementation Plan(s), shall be deemed incorporated therein, and shall be deemed to supersede any conflicting term within the Statement of Work.

5.5 Office Space. The Customer or Court shall, at its sole expense, provide reasonable office space, telephone access, network access, Internet connections, and such other facilities as may be reasonably requested by CSI for use by CSI personnel for the purpose of performing this Agreement while such personnel are working on-site and engaged in Project-related services. CSI personnel shall have access to such facilities at reasonable times and subject to security protocols and business hours of Customer or Court for the purpose of performing this Agreement

5.6 Third Person Hardware and Third Person Software. The Customer or Court shall be responsible to purchase, install, and configure all Third Person Hardware and Third Person Software. The Customer or Court may request a Change Order for CSI personnel to meet with the Customer or Court, on a T&M basis, for the purpose of developing and managing the installation of the Third Person Hardware and/or Third Person Software. CSI shall have no liability for defects in the purchased Third Person Hardware or Third Person Software, and the Customer or Court shall look solely to the manufacturer or other third party and any applicable warranty of such manufacturer or third party to cure any such defects.

5.7 Consulting Services. The Customer or Court may request a Statement of Work for CSI personnel to provide consulting services.

6. DELIVERY AND INSTALLATION OF THE CSI SOFTWARE

6.1 Risk of Loss. Risk of loss of the CSI Software, and media on which such may be delivered, shall remain with CSI at all times until delivery to, and if required pursuant to this Agreement, installation at the Customer's or Court's places of business.

6.2 Deliverables. CSI shall submit the Deliverables under each Statement of Work to the Customer's or Court's place of business in accordance with the timetables set forth in the Statement of Work. Deliverables shall be sent at CSI's expense.

6.3 Installation and Testing.

a CSI shall deliver, install, and verify the CSI Software at the Customer's or Court's places of business in accordance with the timetables set forth in the Statement of Work and pursuant to a verification plan agreed upon by CSI and Customer or Court. Upon installation, CSI shall conduct its standard diagnostic evaluation at the Customer's or Court's site to determine that the CSI Software is properly installed, shall verify operation pursuant to the plan, and shall notify the Customer's or Court's Project Manager after completion thereof.

b The CSI Software shall be deemed installed upon successful completion of the diagnostic tests, and notification to the Customer's or Court's Project Manager of the results.

7. VERIFICATION OF THE CSI SOFTWARE

7.1 Verification Procedure. Upon delivery, installation, and diagnostic testing of the CSI Software pursuant to Section 6, and regardless of whether or not the Customer or Court supplies any test scripts pursuant to Section 7.2, CSI shall perform its standard test procedures as well as testing pursuant to the verification plan developed pursuant to Section 6.3 and provide all test results to the Customer or Court with a certification to the Customer or Court in writing that the CSI Software, including in each applicable Deliverable is operating in accordance with the Specifications for that Deliverable (the "Verification Procedure"). CSI shall promptly correct any Defect revealed during the Verification Procedure. The Customer or Court, in its sole and absolute discretion, may monitor the Verification Procedure.

7.2 Optional – Customer or Court Supplied Test Scripts for Verification Procedure. During the operational analysis of each Deliverable set forth in the Implementation Plan, the Customer or Court may, but is not required to, submit to CSI functional test scripts or other tests for each function to be delivered during such Deliverable, which test scripts and other tests shall be consistent with the Statement of Work and shall be used by the Customer or Court for purposes of verification testing.

7.3 CSI Supplied Test Script Samples. To facilitate the Customer's or Court's development of any such test scripts, CSI may provide to the Customer or Court for its internal use a test script sample set containing test scripts that Customer personnel may use as examples for the development of its test scripts. The Project Managers must agree on the specifics of any Customer or Court supplied test scripts in order for the test scripts to become a part of the Verification Procedures. The Project Managers shall promptly, but in any event not less than ten (10) Business Days, meet in good faith to resolve any issues or disagreements associated with a test script supplied by the Customer or Court. Customer or Court supplied test scripts delivered subsequent to the operational analysis activity of any particular Deliverable shall not apply to the Verification Procedure. The Customer or Court supplied test scripts, if any, shall be in addition to CSI's Verification Procedures set forth in Section 7.1.

8. FINAL ACCEPTANCE

8.1 Operational Use. After the deployment of each Deliverable as set forth in the Statement of Work (and immediately following the successful completion of the associated Verification Procedures set forth in Section 7, the Customer or Court shall begin an operational use period to begin operation by the Customer or Court of the Deliverable ("Operational Use"). Each respective Deliverable shall be deemed to have successfully completed Operational Use when such Deliverable has operated for a period of fifteen (15) consecutive calendar days without a Critical Defect.

a If a Critical Defect occurs during the initial or additional fifteen (15) day period, then the Customer's or Court's Project Manager shall promptly notify CSI's Project Manager in writing, and provided CSI agrees with the Customer's or Court's Project Manager's determination, CSI shall use all reasonable prioritized efforts to promptly cure such Critical Defect. Upon CSI's cure of any such Critical Defect, the fifteen (15) day timetable shall begin again with respect to such Deliverable.

b If a Non-Critical Defect occurs during the initial or additional fifteen(15) day period, then the Customer's or Court's Project Manager shall promptly notify CSI's project manager in writing, and CSI shall use all reasonable efforts to promptly cure such Non-Critical Defect. Upon CSI's cure of any Non-Critical defect, CSI will provide the software to the Customer or Court in the next scheduled software release cycle. Non-Critical Defects are not subject to additional fifteen (15) day Operational Use cycles.

c At the end of the initial or additional fifteen (15) day period(s), as the case may be, each of the Deliverables for which the Customer or Court has not reported a Critical Defect shall be deemed to have successfully passed Operational Use. When each of the Deliverables for which the Customer or Court did report a Critical Defect during the initial fifteen (15) day period or has performed for a period of fifteen (15) consecutive days without a further Critical Defect, that Deliverable shall also be deemed to have successfully passed Operational Use.

8.2 Final Acceptance. When all Deliverables as set forth in the Statement of Work have successfully completed the Operational Use period set forth in Section 8.1, the Customer or Court shall be deemed to have "Final Acceptance" of the CSI Software and the CSI Software shall be subject to the terms and conditions of the Software Maintenance Agreement with respect to ongoing support and enhancement. Customer's or Court's notice of final acceptance shall be timely provided to CSI on a form or in a manner acceptable to CSI.

9. **DOCUMENTATION AND TRAINING**

9.1 **Delivery of Documentation.** Following the successful completion of the Verification Procedures set forth in Section 7 and before the Final Acceptance period in Section 8, CSI shall provide to the Customer or Court the Documentation in electronic format.

9.2 **User Group, Bulletin Boards, and Internet Sites.** In addition to any other maintenance obligation or obligation to provide Documentation, CSI shall notify the Customer or Court of any user group, bulletin board, or internet site relating to the CSI Software or services provided by CSI pursuant to or arising from this Agreement, and to the extent requested by the Customer or Court Project Manager in writing, provide access thereto.

9.3 **Training Plans and Materials; Personnel Training.** CSI shall perform its duties pursuant to or arising from this Section 9.3 as follows:

a CSI shall train Customer or Court personnel in accordance with a mutually agreeable training plan for each Deliverable as defined in the Statements of Work. The training plan shall outline the training required for personnel to operate the CSI Software. CSI and the Customer or Court may jointly develop additional training materials, which training materials shall, among other things, supplement CSI's standard training materials, incorporate the Customer's or Court's business processes, and emphasize the rationale and timing required by a particular operation.

b CSI shall provide Customer or Court personnel with the number of hours of training for the respective portions of the CSI Software as set forth in the Statements of Work, subject to a Change Confirmation.

c Training shall be provided at the Customer's or Court's principal place of business or other site selected by the Customer or Court. Training shall be performed according to the training plan, but in any event shall be "hands-on" using production-ready versions of the CSI Software. The courses shall train the Customer's or Court's employees or agents in a manner to provide basic end user training. The Customer or Court shall be responsible for providing an adequately equipped training facility to operate the CSI Software.

10. **MAINTENANCE SERVICES**

Maintenance and Support Agreement. CSI shall provide the Customer or Court with maintenance and support services for the CSI Software in accordance with the terms of the Software Maintenance Agreement, and Customer or Court shall pay the Maintenance and Support Fees as set forth in any Quotation, Software Maintenance Agreement or the applicable Statement of Work.

11. **MODIFICATIONS TO THE CSI SOFTWARE**

11.1. **CSI Modifications.**

a. CSI shall correct Defects in the CSI Software pursuant to this Agreement and/or the Software Maintenance Agreement, as applicable, and may make Enhancements from time to time to the CSI Software (the "CSI Modifications"). Such Defect corrections and/or Enhancements may result in the creation of a new version(s) of the CSI Software (a "Version Release"). CSI Modifications, any Version Release and all associated intellectual property rights shall solely belong to CSI and shall be deemed part of the CSI Software. CSI in its sole discretion shall decide if any Enhancement is to be provided without cost or whether any Enhancement will be considered a separate product feature to be provided at an additional cost for the Customer or Court to utilize.

Provided that the Customer or Court maintains the CSI Software pursuant to the Software Maintenance Agreement, CSI shall make available to the Customer or Court a copy of the CSI Software with Defect corrections no later than sixty (60) days following general availability of a Version Release. The Customer or Court shall not be immediately obligated to use any Version Release. In the event that the Customer or Court determines to utilize any Version Release, it shall be deemed part of the CSI Software for purposes of this Agreement. In the event the Customer or Court determines not to utilize the current Version Release or the prior version, CSI shall have no obligation to provide maintenance and support to the Customer or Court for such out of date version of the CSI Software.

11.2. **Customer or Court Modifications.** CSI shall have no liability pursuant to this Agreement or the Software Maintenance Agreement for any damages or defects to the CSI Software caused, directly or indirectly, by Customer or Court modifications or instructions or other changes to the CSI Software that are implemented without the prior written consent of CSI ("Customer Modifications").

12. **CONFIDENTIAL INFORMATION AND TRADE SECRETS**

12.1. **Protection of Confidential Information.** Neither party shall use for any purpose other than the performance of this Agreement, or, disclose, disseminate, transmit, publish, distribute, make available, or otherwise convey Confidential Information or trade secrets of the other party to any third party, without such party's prior written consent, unless as expressly provided herein except: (i) as may be required by law, regulation, judicial, or administrative process but subject to Section 12.2 below; or (ii) as required in litigation between the parties pertaining to this Agreement. Each party shall ensure that all employees, individuals, and third parties assigned by it to perform services herein shall abide by the terms of this Section and shall be responsible for breaches by such persons or parties. As provided above, to the extent the Customer or Court engages contractors, subcontractors, or other third parties to assist in the Project to integrate or interface the Licensed Property with Third Person Software, the Customer or Court shall obtain from such third parties an executed CSI Confidentiality Agreement in the form attached hereto as **Exhibit B** prior to such parties being permitted access to CSI Software, CSI Confidential Information, and/or CSI Trade Secrets. Customer and Court agrees that it shall not allow anyone access to the foregoing items for any other purpose whatsoever.

12.2. Judicial Proceedings. Subject to applicable law, if either party is requested or required (by oral questions, interrogatories, requests for information or documents in legal proceedings, subpoena, civil investigative demand, or other similar process) to disclose any Confidential Information or trade secrets of the other party, then such party shall provide the other with prompt written notice of such request or requirement so that the appropriate party may seek protective orders or other appropriate remedies and/or waive compliance with the provisions of this Agreement. If, in the absence of a protective order or other remedy or the receipt of a waiver by the disclosing party, the receiving party nonetheless is legally compelled to disclose Confidential Information or trade secrets to any court or tribunal or else would stand liable for contempt or suffer other censure or penalty, the receiving party may, without liability herein, disclose to such court or tribunal only that portion of Confidential Information or trade secrets which the court requires to be disclosed, provided that the receiving party uses reasonable efforts to preserve the confidentiality of the Confidential Information or trade secrets, including, without limitation, by cooperating with the disclosing party to obtain an appropriate protective order or other reliable assurance that confidential treatment shall be accorded the Confidential Information or trade secrets by such court or tribunal.

13. PROHIBITION ON PUBLICITY

With the exception of any published statement prior to the Effective Date (including any testimonials, case studies and the like) and subject to applicable laws, including laws regarding public disclosure of contracting processes, contracts, and other records which apply to Customer or Court, neither Party shall use any name, trademark, or trade name of the other Party, directly or indirectly, whether in connection with advertising, without the prior written consent of the other Party as to each circumstance and occasion of use, which such consent may be revoked at the reasonable discretion of the Party giving consent. CSI shall not claim that the Customer or Court endorses its products or services without the prior written consent of the Customer or Court, which such consent may be revoked at the Customer's or Court's reasonable discretion. Notwithstanding anything in this Agreement to the contrary, either Party may disclose to the public the existence of this Agreement, the Parties to the Agreement, and the material terms of the Agreement, including price, projected term, and scope of work.

14. REPRESENTATIONS AND WARRANTIES

14.1. Media Defects. The media on which the CSI Software is provided shall, at the time of delivery and installation, be free of Defects in material and workmanship.

14.2. Defects. Upon Final Acceptance and for a period of ninety (90) days thereafter (the "Warranty Period"), the CSI Software shall be free of Critical Defects. In the event that any Non-Critical Defects are identified during the Warranty Period, CSI shall apply reasonable efforts (and in all cases provide at least the level of responsiveness and resolution as provided for in the Software Maintenance Agreement) to cure such Non-Critical Defects.

14.3. Pass-Through of Warranties. To the extent legally possible, CSI hereby passes through the benefits of all third party warranties that it receives in connection with any Embedded Third Party Software provided to the Customer or Court.

14.4. Governmental Consent. No consent, approval, or withholding of objection is required from any governmental authority with respect to CSI's entering into or the performance of this Agreement.

14.5. Free and Clear Title. CSI has free and clear title (including all proprietary rights) to any Licensed Property delivered hereunder (other than Embedded Third Party Software) and that it has the right to license any and all CSI Software that is licensed hereunder.

14.6. Future Support. Throughout the term of the Software Maintenance Agreement and provided that the Customer or Court is not in breach of the Software Maintenance Agreement, CSI shall correct or otherwise cure Defects to the current Version Release of CSI Software made available to Customer.

14.7. Documentation and Knowledge Transfer. The Documentation provided by CSI shall be sufficient to permit users to access and operate all features and to permit the Customer's or Court's trainers, helpdesk and administrative personnel to perform their functions.

14.8. Services. All Services shall be performed in a timely, professional and workmanlike manner using appropriate resources and personnel.

14.9. Corporate or Governmental Authority. CSI has all requisite corporate power and authority to execute and deliver this Agreement, to perform its obligations herein, and to consummate the transactions contemplated hereby. The Customer or Court has all requisite power and authority to execute and deliver this Agreement, to perform its obligations herein, and to consummate the transactions contemplated hereby. The execution and delivery of this Agreement and the consummation of the transactions contemplated hereby have been duly authorized by all necessary corporate, governmental, or other actions, and no other proceedings on the part of CSI or the Customer or Court are necessary to authorize this Agreement or to consummate the transactions contemplated hereby.

14.10. Certain Business Practices. Neither Party nor any of its principals is presently debarred, suspended, proposed for debarment, declared ineligible, or voluntarily excluded from participating in this Agreement by any Arkansas or federal department or agency.

14.11. Signatory Warranty. The person or persons signing and executing this Agreement on behalf of CSI and the Customer do hereby warrant and guarantee that he, she, or they have been duly authorized to execute this Agreement on behalf of CSI or the Customer and to validly and legally bind CSI and Customer to all terms, conditions, and provisions herein set forth.

14.12. Illicit Code. CSI has not knowingly introduced through any media, any virus, worm, trap door, back door, bomb, bug, or other contaminant or disabling device that may have the effect or be used to access, alter, delete, limit, control, damage, or disable any Customer property.

14.13. Interoperability. Subject to Section 5.6, the CSI Software shall be substantially interoperable with any Third Person Software and Third Person Hardware that the Customer or Court has identified in a Statement of Work prior to the delivery and installation of the CSI Software pursuant to Section 6.

EXCEPT AS SPECIFICALLY SET FORTH IN THIS SECTION 14 OR ELSEWHERE IN THIS AGREEMENT, CSI DISCLAIMS ALL OTHER WARRANTIES, INCLUDING, WITHOUT LIMITATION, THE IMPLIED WARRANTIES OF MERCHANTABILITY AND FITNESS FOR A PARTICULAR PURPOSE.

15. LIMITATION OF LIABILITY

THE LIABILITY OF CSI, CUSTOMER, OR COURT FOR DAMAGES ARISING OUT OF OR IN CONNECTION WITH THIS AGREEMENT, WHETHER BASED ON A THEORY OF CONTRACT OR TORT, INCLUDING NEGLIGENCE AND STRICT LIABILITY, SHALL BE LIMITED TO: (A) PRIOR TO COMPLETION OF OPERATIONAL USE FOR ANY DELIVERABLE AS DETAILED IN THE APPLICABLE STATEMENT OF WORK, THE LICENSE FEES PAID OR OWED BY THE CUSTOMER OR COURT TO CSI FOR SUCH DELIVERABLE AS DETAILED IN THE APPLICABLE STATEMENT OF WORK; AND (B) AFTER COMPLETION OF OPERATIONAL USE FOR ANY DELIVERABLE, CSI'S OBLIGATIONS AS SET FORTH IN THE TERMS AND CONDITIONS OF THE SOFTWARE MAINTENANCE AGREEMENT WITH RESPECT OF SUCH AFFECTED COMPONENT OR MODULE WHICH IS THE CAUSE OF CONTROVERSY. THE FOREGOING LIMITATIONS DO NOT APPLY TO THE FOLLOWING CIRCUMSTANCES: (1) FRAUD OR (2) FOR OBLIGATIONS ARISING UNDER SECTION 16.1 (CLAIMS FOR BODILY INJURY OR PROPERTY DAMAGE) OR OBLIGATIONS ARISING UNDER SECTION 16.2 (INTELLECTUAL PROPERTY INFRINGEMENT), (3) LOSS OF DATA OR BREACH OF CONFIDENTIALITY RESULTING FROM THE WILLFUL MISCONDUCT OF PARTY OR PARTY'S EMPLOYEE. IN NO EVENT SHALL EITHER PARTY BE LIABLE TO THE OTHER PARTY (NOR TO ANY PERSON CLAIMING ANY RIGHT, TITLE, OR INTEREST DERIVED FROM OR AS SUCCESSOR TO THE CUSTOMER'S RIGHT, TITLE, AND INTEREST) FOR INCIDENTAL, PUNITIVE, CONSEQUENTIAL, OR SPECIAL DAMAGES OF ANY KIND, INCLUDING, WITHOUT LIMITATION, LOST REVENUES OR PROFITS, OR LOSS OF BUSINESS OR NEGLIGENT LOSS OF DATA ARISING OUT OF THIS AGREEMENT, IRRESPECTIVE OF WHETHER THE PARTIES HAVE ADVANCE NOTICE OF THE POSSIBILITY OF SUCH DAMAGE.

16. INDEMNIFICATION

16.1. General Bodily Injury and Property Damage. Notwithstanding any other provision of this Agreement, CSI shall defend, indemnify, hold, and save harmless the Customer or Court Indemnified Parties from and against any and all Claims for bodily injury or property damage sustained by or asserted against the Customer arising out of, resulting from, or attributable to the negligent or willful misconduct of CSI, its employees, subcontractors, representatives, and agents; provided, however, that CSI shall not be liable herein to indemnify the Customer Indemnified Parties against liability for damages arising out of bodily injury to people or damage to property to the extent that such bodily injury or property damage is caused by or resulting from the actions, negligent or otherwise, of the Customer, its agents, contractors, subcontractors, or employees. Notwithstanding any other provision of this Agreement, the Customer or Court shall defend, indemnify, hold, and save harmless the CSI Indemnified Parties from and against any and all Claims for bodily injury or property damage sustained by or asserted against CSI arising out of, resulting from, or attributable to the negligent or willful misconduct of the Customer, its employees, subcontractors, representatives, and agents; provided, however, that the Customer shall not be liable herein to indemnify the CSI Indemnified Parties against liability for damages arising out of bodily injury to people or damage to property to the extent that such bodily injury or property damage is caused by or resulting from the actions, negligent or otherwise, of CSI, its agents, contractors, subcontractors, or employees.

16.2 Intellectual Property Infringement.

a) Notwithstanding any other provision of this Agreement, if any claim is asserted, or action or proceeding brought against the Customer or Court that alleges that all or any part of the CSI Software, in the form supplied, or modified by CSI, or the Customer's or Court's use thereof, infringes or misappropriates any United States intellectual property, intangible asset, or other proprietary right, title, or interest (including, without limitation, any copyright or patent or any trade secret right, title, or interest), or violates any other contract, license, grant, or other proprietary right of any third party, the Customer or Court, upon notice of such assertion, shall give CSI prompt written notice thereof. CSI shall defend, and hold the Customer or Court Indemnified Parties harmless against, any such claim or action with counsel of CSI's choice and at CSI's expense and shall indemnify the Customer Indemnified Parties against any liability, damages, and costs resulting from such claim. The Customer or Court shall cooperate with and may monitor CSI in the defense of any claim, action, or proceeding and shall, if appropriate, make employees available as CSI may reasonably request with regard to such defense. This indemnity does not apply to the extent that such a Claim is attributable to (i) modifications to the CSI Software made by the Customer or Court or at the request of the Customer or Court, (ii) integration of the CSI Software with any Third Person Software, or (iii) any third party pursuant to the Customer's or Court's directions, or upon the unauthorized use of the CSI Software by the Customer or Court. If any of the foregoing causes in the preceding sentence are the result of any Claims, the Customer or Court shall defend and hold the CSI Indemnified Parties harmless in accordance to the above procedures.

b) Mitigation. If the CSI Software becomes the subject of a claim of infringement or misappropriation of a copyright, patent, or trade secret or the violation of any other contractual or proprietary right of any third party, CSI shall, at its sole discretion, and expense, select and provide one of the following remedies, which selection shall be in CSI's sole discretion:

- i. replace the CSI Software with a compatible, functionally equivalent, non-infringing system; or
- ii. modify the CSI Software to make it non infringing; or
- iii. procure the right of the Customer or Court to use the CSI Software as intended.

17. TAXES

17.1. Tax Exempt Status. If the Customer is a governmental tax-exempt entity, it shall not be responsible for any taxes for any Licensed Property or services provided for herein, whether federal or state. Otherwise, the fees paid to CSI pursuant to this Agreement are exclusive of any applicable sales, use, personal property, or other taxes attributable to periods on or after the Effective Date of this Agreement and based upon or measured by CSI's cost in acquiring or providing products and/or services and related materials and supplies furnished or used by CSI in performing its obligations herein, including all personal property and use taxes, if any, due on equipment or software owned by CSI.

17.2. Employee Tax Obligations. Each Party accepts full and exclusive liability for the payment of any and all contributions or taxes for Social Security, Workers' Compensation Insurance, Unemployment Insurance, or Retirement Benefits, Pensions, or annuities now or hereafter

imposed pursuant to or arising from any state or federal laws which are measured by the wages, salaries, or other remuneration pay to persons employed by such Party for work performed pursuant to or arising from the terms of this Agreement.

18. INSURANCE

CSI shall provide proof of insurance for and maintain, at CSI's sole cost and expense, the following insurance coverage: (a) Industrial/Workers' Compensation Insurance protecting CSI and the Customer or Court from potential CSI employee claims based upon job-related sickness, injury, or accident during performance of this Agreement; and (b) Comprehensive General Liability (including, without limitation, bodily injury and property damage) insurance with respect to CSI's agents and vehicles assigned to perform the services herein with policy limits of not less than \$1,000,000 combined single limit per occurrence and \$2,000,000 in the aggregate.

19. TERM, SUSPENSION, AND TERMINATION

19.1. Term. The term of this Agreement (the "Term") shall commence on the Effective Date and shall continue until a) the Agreement is terminated pursuant to this Section 19, or b) June 30, 2017 (the "Initial Term"), whichever is earlier. At the expiration of the Initial Term, this Agreement will automatically renew for successive two-year Terms unless any Party provides the other Party with notice of its intent not to renew this Agreement at least one hundred twenty (120) days prior to the expiration of the then current Term.

19.2. Suspension. The Customer or Court may, in its sole discretion, suspend the services to be performed under the Implementation Plan for a period of time by issuing a written order to stop work and by: a) paying to CSI concurrently therewith for all amounts due and owing to CSI, including research, development and professional services work in progress but not yet delivered and up through the date of the written order to stop work and, b) making full payment to CSI for any equipment or third party software licenses CSI may have acquired to fulfill this Agreement. The written order shall set out the terms of the suspension. Upon receipt of the written order to stop work and payment in full for equipment or third party software licenses, as well as full payment for all services performed up through the date of the written order to stop work, CSI shall stop all services and shall cease to incur costs to the Customer or Court during the term of the suspension. CSI shall resume work when notified to do so by the Customer or Court in a written authorization to proceed. CSI shall have no liability whatsoever for delays in the Implementation Plan caused by the Customer's or Court's suspension of services. In no event shall CSI be required to resume services after three (3) months following the date of the written order to stop work.

19.3. Termination for Cause. Either Party may terminate this Agreement for Cause, provided that such Party follows the procedures set forth in this Section.

a For purposes of this Section, "Cause" means either:

i a material breach of this Agreement, which has not been cured within ninety (90) days of the date such Party receives written notice of such breach;

ii the failure by the Customer to timely pay when due any fees and expenses owed to CSI pursuant to this Agreement and any delinquent amounts remain outstanding for a period of thirty (30) days after CSI provides written notice of its intent to terminate for failure to pay;

iii breach of Sections 3 or 12;

iv a suspension of services by the Customer pursuant to Section 19.2 that lasts for at least three (3) months;
or

v if either party as applicable becomes insolvent or bankrupt, or is the subject of any proceedings relating to its liquidation or insolvency or for the appointment of a receiver or similar officer for it, has a receiver of its assets or property appointed or makes an assignment for the benefit of all or substantially all of its creditors, or institutes or causes to be instituted any proceeding in bankruptcy or reorganization or rearrangement of its affairs;

vi it is determined by the Customer or Court that CSI has made material misrepresentations in its response (**Exhibit D**) to Customer RFP (**Exhibit C**).

b No Party may terminate this Agreement under this Section 19.3 until it notifies the other Party in writing of the existence of such material breach, provides the alleged breaching Party with time to cure such alleged breach, cooperates with the alleged breaching Party during time period on a good faith basis to cure such alleged breach, and complies in good faith with the dispute resolution procedures set forth in Section 20 following such period. The cooperation procedures set forth in this Section 19.3(b) do not apply for a termination for Cause as defined in Section 19.3 (a)(ii),(a)(iii),(a)(iv), (a)(v), or (a)(vi).

c In the event either Party terminates this Agreement pursuant to this Section 19.3, each Party shall return all Licensed Property, products, documentation, confidential information, and other information disclosed or otherwise delivered to the other Party prior to such termination and all revocable licenses granted herein to the Licensed Property shall automatically terminate.

d Survival. The following provisions shall survive after the Term of this Agreement: 3;12;13;15;20; and 21.

19.4. Termination for Non-Appropriation. Funds for this Agreement are payable from City, County, State and Federal appropriations. In the event no funds or insufficient funds are appropriated and budgeted in any fiscal year for payments due under this contract, the Customer or Court shall immediately notify CSI or its assignee, of such occurrence, and this Agreement may create no further obligation of the City, County, or State as to such current or succeeding fiscal year, and may be null and void, except as to the portions of payments herein agreed upon for funds which shall have been appropriated and budgeted. In such event, this contract may be terminated, without penalty or

expense to the Customer or Court of any kind whatsoever, on the last day of the fiscal year for which appropriations were received. After such termination of this contract, the Customer or Court shall have no continuing obligation to make purchases under this contract. No right of action or damages shall accrue to the benefit of CSI or its assignee as to that portion of this contract, which may so terminate. Notwithstanding the foregoing, Customer or Court shall remain responsible for all fees and amounts due to CSI for any deliverables provided or services performed by CSI prior to the date of termination.

19.5. Termination for Convenience. This Agreement may be terminated for any reason by any Party provided a one hundred and twenty (120) day advance notice, in writing, is provided to the other Party. In the event that this Agreement is terminated or canceled upon request and for the convenience of either Party without sixty (60) days advance written notice, then the Parties shall negotiate reasonable termination costs, if applicable. Notwithstanding the foregoing Customer or Court shall remain responsible for all fees and amounts due to CSI for any deliverables provided or services performed by CSI prior to the date of termination.

20. DISPUTE RESOLUTION

Disputes arising out of, or relating to, this Agreement shall first be discussed by the Project Managers. Any dispute that cannot be resolved within five (5) Business Days at the Project Manager level (or such other date as agreed upon by the Project Managers) shall be referred to the individual reasonably designated by the Customer or Court and CSI's Director of Project Management ("Intermediary Dispute Level"). Any dispute that cannot be resolved in ten (10) Business Days at the Intermediary Dispute Level shall then be referred to an executive officer designated by the Customer or Court and CSI's President, Vice President, or Chief Operating Officer ("Executive Dispute Level"), at such time and location reasonably designated by the Parties. Any negotiations pursuant to this Section 20 are confidential to the extent permitted by law and shall be treated as compromise and settlement negotiations for purposes of the applicable rules of evidence. For any dispute that the Parties are unable to resolve through informal discussions or negotiations or pursuant to the dispute resolution and escalation procedures set forth in this Agreement, the Parties shall submit the matter to binding arbitration. Any such arbitration proceeding shall be governed by the rules of the American Arbitration Association. Any award or other relief granted by the arbitrators may be enforced in any court of competent jurisdiction subject to Section 21.11 of this Agreement. The foregoing shall not apply to claims for equitable relief under Section 12.

21. MISCELLANEOUS

21.1. Assignment. Neither Party shall assign this Agreement or any of its respective rights or obligations herein to any third party without the express written consent of the other Party, which consent shall not be unreasonably withheld.

21.2. If assigned pursuant to 21.1, Agreement shall be binding upon same instrument and inure to the benefit of each of the Parties and, except as otherwise provided herein, their respective legal successors and permitted assigns.

21.3. Cumulative Remedies. Except as specifically provided herein, no remedy made available herein is intended to be exclusive of any other remedy, and each and every remedy shall be cumulative and shall be in addition to every other remedy provided herein or available at law or in equity.

21.4. Notices. Except as otherwise expressly specified herein, all notices except service of process, requests or other communications shall be in writing and shall be deemed to have been given if delivered personally or mailed, by certified or registered mail, postage prepaid, return receipt requested, to the Parties at their respective addresses set forth on the signature page hereto, or at such other addresses as may be specified in writing by either of the Parties or delivered by electronic means to the person designated to receive such electronic notice. For other than electronic notices, all notices, requests, or communications shall be deemed effective upon personal delivery or three business (3) days following deposit in the mail.

21.5. Counterparts. This Agreement may be executed in one or more counterparts, each of which shall be deemed an original, but all of which together shall constitute one and the same. The Parties acknowledge and accept that signatures sent via facsimile and/or email in a PDF document shall be as legally binding as signatures upon originals.

21.6. Waiver. The performance of any obligation required of a Party herein may be waived only by a written waiver signed by the other Party, which waiver shall be effective only with respect to the specific obligation described therein.

21.7. Entire Agreement. This Agreement and referenced attachments and exhibits herein constitute the entire understanding and contract between the Parties.

21.8. Amendment. This Agreement shall not be modified, amended, or in any way altered except by an instrument in writing signed by the properly delegated authority of each Party or as otherwise provided herein (e.g., Change Confirmations). All amendments or modifications of this Agreement shall be binding upon the Parties despite any lack of consideration.

21.9. Severability of Provisions. In the event any provision hereof is found invalid or unenforceable pursuant to judicial decree, the remainder of this Agreement shall remain valid and enforceable according to its terms.

21.10. Relationship of Parties. The Parties intend that the relationship between the Parties created pursuant to or arising from this Agreement is that of an independent contractor only. Neither Party shall be considered an agent, representative, or employee of the other Party for any purpose.

21.11. Governing Law. This Agreement shall be governed by and construed in accordance with the laws of the State of Arkansas including Arkansas Code Annotated § 19-11-246. CSI waives any objection it may have now or hereafter to the administrative process required by Arkansas Code Annotated § 19-11-246. To the extent that Arkansas Code Annotated § 19-11-246, by its own terms, does not govern a claim or controversy arising out of or relating to the agreement, any suit, action, or proceeding arising out of or relating to the Agreement shall be governed by the laws of the State of Arkansas. CSI agrees that any act by Customer or Court regarding the Agreement is not a waiver of either the Customer's or Court's sovereign immunity or the Customer or Court's immunity under the Eleventh Amendment of the United States Constitution. CSI agrees that any suit, action, or proceeding arising out of or relating to the Agreement shall be instituted and maintained only in a state or federal court located in Pulaski County, State of Arkansas.

21.12. No Third Party Beneficiaries. Nothing in this Agreement is intended to benefit, create any rights in, or otherwise vest any rights upon any third party.

21.13. Force Majeure. With the exception of any overdue payment of fees hereunder, no Party to this Agreement shall be liable for delay or failure in the performance of its contractual obligations arising from any one or more events that are beyond its reasonable control, including, without limitation, acts of God, war, terrorism, and riot. Upon such delay or failure affecting one Party, that Party shall notify the other Party and use all reasonable efforts to cure or alleviate the cause of such delay or failure with a view to resuming performance of its contractual obligations as soon as practicable. Notwithstanding the foregoing, in every case the delay or failure to perform must be beyond the control and without the fault or negligence of the Party claiming excusable delay. Any performance times pursuant to or arising from this Agreement shall be considered extended for a period of time equivalent to the time lost because of any delay that is excusable herein.

21.14. Equitable Relief. Each Party covenants, represents, and warrants that any violation of this Agreement by such Party with respect to its respective obligations set forth in Sections 3.2 and 12 shall cause irreparable injury to the other Party and shall entitle the other Party to extraordinary and equitable relief by a court of competent jurisdiction, subject to Section 21.11 above, including, without limitation, temporary restraining orders and preliminary and permanent injunctions, without the necessity of posting bond or security.

21.15. Attorneys' Fees and Costs. In the event of any litigation or arbitration between the Parties in connection with or arising out of this Agreement, or to enforce any right or obligation of either Party under this Agreement, or for declaratory judgment, or for the construction or interpretation of this Agreement or any right or obligation under or impacted by this Agreement (in each case, a "Proceeding"), neither Party shall be entitled to recover attorneys' fees or costs. This provision is specifically agreed upon to encourage good faith resolution of performance or fee issues and to discourage litigation.

21.16. Conditions of Agreement and Order of Precedence. The following documents are incorporated into this Agreement for purposes of this section 21.16 by this reference as fully as if written out below:

- State of Arkansas, Arkansas Supreme Court, Administrative Office of the Courts, Request for Proposals Image and Electronic Document Redaction, issued February 17, 2014 as amended March 12, 2014, attached as Exhibit C.
- CSI Proposal in response to RFP, submitted March 27, 2014, attached as Exhibit D.

In the event of any actual conflict between this Agreement and the other agreements and documents incorporated herein by reference shall be determined by the following priority order: (1) any written amendment signed by CSI and Customer which resolves any difference between or among the Agreement; (2) Quotations; (3) Change Orders; (4) Authorization Orders; (5) Statements of Work; (6) Software Maintenance Agreement; (7) the express terms of this Agreement; then (8) Exhibit D; then, (9) Exhibit C.

21.17. Technology Access. CSI expressly acknowledges and agrees that state funds may not be expended in connection with the purchase of information technology unless that system meets the statutory requirements found in 36 C.F.R. § 1194.21, as it existed on January 1, 2013 (software applications and operating systems) and 36 C.F.R. § 1194.22, as it existed on January 1, 2013 (web-based intranet and internet information and applications), in accordance with the State of Arkansas technology policy standards relating to accessibility by persons with visual impairments.

ACCORDINGLY, CSI EXPRESSLY REPRESENTS AND WARRANTS to the State of Arkansas that the technology provided to the State for purchase is capable, either by virtue of features included within the technology, or because it is readily adaptable by use with other technology, of:

- Providing, to the extent required by Arkansas Code Annotated § 25-26-201 et seq., as amended by Act 308 of 2013, equivalent access for effective use by both visual and non-visual means;
- Presenting information, including prompts used for interactive communications, in formats intended for non-visual use;
- After being made accessible, integrating into networks for obtaining, retrieving, and disseminating information used by individuals who are not blind or visually impaired;
- Providing effective, interactive control and use of the technology, including without limitation the operating system, software applications, and format of the data presented is readily achievable by nonvisual means;
- Being compatible with information technology used by other individuals with whom the blind or visually impaired individuals interact;
- Integrating into networks used to share communications among employees, program participants, and the public; and
- Providing the capability of equivalent access by nonvisual means to telecommunications or other interconnected network services used by persons who are not blind or visually impaired.

For purposes of this section, the phrase "equivalent access" means a substantially similar ability to communicate with, or make use of, the technology, either directly, by features incorporated within the technology, or by other reasonable means such as assistive devices or services which would constitute reasonable accommodations under the Americans with Disabilities Act or similar state and federal laws. Examples of methods by which equivalent access may be provided include, but are not limited to, keyboard alternatives to mouse commands or other means of navigating graphical displays, and customizable display appearance. As provided in Act 308 of 2013, if equivalent access is not reasonably available, then individuals who are blind or visually impaired shall be provided a reasonable accommodation as defined in 42 U.S.C. § 12111(9), as it existed on January 1, 2013.

As provided in Act 308 of 2013, if the information manipulated or presented by the product is inherently visual in nature, so that its meaning cannot be conveyed non-visually, these specifications do not prohibit the purchase or use of an information technology product that does not meet these standards.

21.18. Compliance with Administrative Order 19. CSI will comply with *Arkansas Supreme Court Administrative Order 19 – Access to Public Records, Section X. Contracts With Vendors Providing Information Technology Services Regarding Court Records*. CSI will comply with the intent and provisions of this access policy. CSI will assist the Court in its role of educating litigants and the public about this order. The vendor shall also be responsible for training its employees and subcontractors about the provisions of this order. CSI is prohibited from disseminating bulk or compiled information, without first obtaining approval as required by Administrative Order 19. CSI acknowledges that Court records remain the property of the Court and are subject to the directions and orders of the Court with respect to the handling and access to the Court records, as well as the provisions of Administrative Order 19.

21.19. Ownership of Data. All data and other records entered into any databases of the Customer or a Court or supplied to the vendor by the Customer or Court are, and shall remain, the sole property of the Customer or Court. CSI shall not copy or use such records without the Customer's or Court's written consent except to carry out contracted work, or transfer or disclose the contents of such records to any other party not involved in the performance of this agreement.

22. Pricing – Costs to Customer or Court for software or services shall be as described in the Cost Proposal of Exhibit D, an excerpt of which is included in this section:

Pricing

There are two categories required for the cost proposal:

1. The cost to AOC for software and services to meet the first two project goals:
 - redaction of electronic documents currently stored in the central Contexte database;
 - redaction of documents when delivered to the AOC for storage in the Contexte repository as part of an electronic filing implementation;
2. The cost for individual courts should they desire to engage the vendor to meet the second two project goals:
 - a state contract that will allow courts to purchase the services of the vendor for redaction of images and electronic documents currently stored in local DMS repositories;
 - a state contract that will allow court users to purchase vendor software or services to be able to interactively redact documents as part of an historical back-file scanning project.

As the RFP has identified two distinct combinations of redaction processing (i.e. all documents either in an existing repository or as they are added to a repository, and redaction on demand as documents are being requested for public viewing) we are providing simplified statewide pricing to utilize for both.

The statewide pricing provided is by unit/image, allowing the AOC or county to select the exact license volume desired and provide the best unit price to all purchasers irrelevant of their individual size or license volume.

An Intellidact “single use” license is purchased for the processing of one image one time. An Intellidact “perpetual use” license is purchased one time for processing of images in perpetuity. Perpetual licenses have an additional charge of 18% software maintenance per year and single use licenses do not have a cost for software maintenance.

For AOC and County back file redaction projects it is recommended that a “single use” license provides the greatest cost savings to the State. For redaction on demand projects it is recommended that a “perpetual” license provides the greatest cost savings to the state.

By providing a single statewide unit price model each and every county gets the benefits of purchasing at the lowest unit cost irrespective of their document volumes, which traditionally have been lower volumes have higher unit pricing than higher volumes.

With that said, there are also several different options requests for processing:

- Intellidact redaction software installed at customer site with customer processing and validation
- Customer documents provided to CSI for automated processing at CSI with customer performing remote validation
- Customer documents provided for CSI for automated processing at CSI with CSI performing manual validation

Item	Description	Unit price	Total price
1	Intellidact single use license – per image cost (Customer processing and validation)	1.1 cent per image	Number of images times unit price
2	Intellidact perpetual license – per image cost (Customer processing and validation)	3.5 cents per image	Number of images times unit price + [yearly support price of 18% of license price]
3	Universal Web services per county	\$2,000	\$2,000
4	Universal Web services site license (all counties and AOC)	\$50,000	\$50,000
5	Remote installation, training, and project management (per onsite install)	\$3,500	\$3,500 plus any travel and living expenses if onsite presence requested
6	Intellidact single use license – per image cost (CSI processing and customer validation)	1.75 cents per image	Number of images times unit price
7	Intellidact single use license – per image cost (CSI processing and CSI validation)	2.4 cents per image	Number of images times unit price
8	Intellidact datacenter setup and project management per customer project	\$2,500	\$2,500
9	Intellidact development services (integration development if needed)	\$150/hour	Total number of hours times \$150
10	Intellidact Search [Optional]	\$12,000 per year per 4 CPU core node	\$12,000 x number of nodes

23. PROCEDURE – Because this Agreement contemplates software and services to be provided by CSI to Customer, to Courts, or to both Customer and Courts, the following procedure shall be utilized to ensure that all Parties are involved to the extent they may be impacted by acquisition of software or services under this Agreement.

23.1. Customer Requests Software or Services. If Customer requests software or services under this contract for the Arkansas Supreme Court or Arkansas Court of Appeals, CSI shall provide a quote and Statement of Work for the software or services. Acceptance of the quote and Statement of Work shall be executed by both the Customer and the Clerk of the Supreme Court and Court of Appeals.

23.2. Court Requests Software or Services. If a Circuit Court or District Court requests software or services under this contract, CSI shall provide to both Customer and Court a quote and Statement of Work for the software or services. Within five (5) business days after receiving the quote and Statement of Work, Customer shall determine whether Customer's resources are impacted by the quote and Statement of Work.

- a) If Customer's resources are impacted by the quote and Statement of Work, Customer shall notify CSI and Court that Customer is required to be a signatory to the Statement of Work and will indicate the earliest availability of Customer's resources for the required work.
- b) If Customer's resources are not impacted by the quote and Statement of Work, Customer shall notify CSI and Court that Customer is not impacted, and CSI and Court are cleared to proceed under this Agreement without Customer involvement.

[Signature page follows]

IN WITNESS WHEREOF, this Agreement has been executed by a duly authorized officer of each Party hereto as of the date first above written.

**Sal, Johnson & associates, Inc. d/b/a
Computing System Innovations**

**Arkansas Supreme Court
Administrative Office of the Courts**

By:

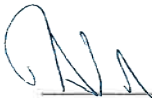

By:



Name: Henry Sal

Name:

JAMES D GINGRICH

Title: President

Title:

DIRECTOR, AOC

Address: 791 Piedmont Wekiwa Road
Apopka Florida 32703

Address: 625 Marshall Street
Little Rock Arkansas 72201

Exhibit A
Software Maintenance Agreement

EXHIBIT A to Master Services Agreement

SOFTWARE MAINTENANCE AGREEMENT

between

**SAL, JOHNSON & ASSOCIATES, Inc.
d/b/a COMPUTING SYSTEM INNOVATIONS**

("CSI")

a Florida corporation

having its principal place of business at:

791 Piedmont Wekiwa Road

Apopka, Florida 32703

and

**Arkansas Supreme Court
Administrative Office of the Courts**

("Customer")

having its principal address at:

625 Marshall Street

Little Rock, Arkansas 72201

This Software Maintenance Agreement (this "Agreement") by and between Sal, Johnson & Associates, Inc. d/b/a Computing System Innovations ("CSI") and Arkansas Supreme Court Administrative Office of the Courts ("Customer") is attached as Exhibit A and hereby made part of that certain Master Services Agreement (the "MSA") by and between CSI and Customer.

(1) Definitions and Identifications. For purposes of this Agreement, the terms below shall have the meanings as defined in this Section 1. Unless otherwise specifically provided herein, any terms defined in the MSA and used herein shall have the same meaning as detailed in the MSA when used in this Agreement.

(a) *Basic Maintenance Period* - the basic maintenance period specified in Section 6 of this Agreement.

(b) *Covered Maintenance Services* - includes all Conformity Maintenance Services and all Upgrade Maintenance Services.

(c) *Conformity Maintenance Services* - services necessary to insure that the CSI Software operates in conformity with all Specifications.

(d) *Critical Defect* - a bug, error, malfunction or other defect in the CSI Software which renders the CSI Software inoperable and without having a workaround to become operable.

(e) *Maintenance and Support Fees* - the fees for Covered Maintenance Services specified in Section 7 of this Agreement.

(f) *Non-Critical Defect* - any defect in the CSI Software other than a Critical Defect.

(g) *Online Support* - the provision of diagnostic advice and assistance concerning the use and operation of the CSI Software via a virtual private network or similar method.

(h) *Telephone Support* - the provision of general information and diagnostic advice and assistance concerning the use and operation of the CSI Software via telephone.

(i) *Upgrade Maintenance Services* - any Enhancement developed by CSI for the CSI Software and related Documentation during the term of this Agreement.

(2) Scope of Agreement. This Agreement covers the maintenance of CSI Software licensed and delivered by CSI for the benefit of Customer or Court pursuant to the MSA. **THIS AGREEMENT PROVIDES MAINTENANCE SERVICES ONLY WITH RESPECT TO CSI SOFTWARE, INCLUDING EMBEDDED THIRD PARTY SOFTWARE, SUPPLIED BY CSI TO CUSTOMER OR COURT PURSUANT TO THE TERMS OF THE MSA. THIS AGREEMENT DOES NOT PROVIDE FOR MAINTENANCE SERVICES FOR ANY THIRD PERSON SOFTWARE OR THIRD PERSON HARDWARE NOT SUPPLIED BY CSI TO CUSTOMER OR COURT.**

(3) Initial Maintenance Term. The initial term ("Initial Term") of this Agreement shall begin following the expiration of the Warranty Period pursuant to Section 14.2 of the MSA ("Maintenance Agreement Effective Date"). Unless sooner terminated in accordance with Section 15 hereof, the

Initial Term of this Agreement shall remain in effect for a period of one (1) year from the Maintenance Agreement Effective Date.

(4) Automatic Renewal and Subsequent Term. Upon expiration of the Initial Term or any Subsequent Term as defined below, this Agreement shall be automatically extended for successive one (1) year periods (each such one (1) year period referred to as a "Subsequent Term"), unless this Agreement is terminated during the Initial Term or any Subsequent Term in accordance with Section 15 of this Agreement.

(5) CSI Software; Ownership. This Agreement covers all CSI Software as described in any Statement of Work executed between CSI and Customer or Court pursuant to the MSA and attached thereto. Unless Customer or Court otherwise notifies CSI in writing, all subsequently ordered CSI Software installed by CSI shall be automatically subject to this Agreement immediately upon the expiration of the Warranty Period without any separately executed agreement for such subsequently ordered and installed CSI Software, provided that such order and installation of CSI Software was requested and approved by Customer or Court, as detailed in an executed Statement of Work or CSI Quotation. All changes, modifications, Enhancements, and other additions or improvements to the CSI Software or any Documentation including all associated intellectual property rights thereto shall remain the sole and exclusive property of CSI, and shall be subject to all of the terms and conditions of the MSA.

(6) Basic Maintenance Period. The Basic Maintenance Period commences on Monday and continues through Friday of each week (8:00 a.m. to 5:00 p.m., Eastern Standard Time), excepting any day that is a federal holiday

(7) Maintenance and Support Fees. Maintenance and Support Fees during the Initial Term shall be set forth in any Quotations and/or Statement of Work detailing the CSI Software being licensed under the MSA. Maintenance and Support Fees become effective upon the Maintenance Agreement Effective Date with respect to the applicable CSI Software. For each Subsequent Term, Maintenance and Support Fees will be based on the then current CSI Maintenance and Support Fees, but shall not be increased by more than 5% per year over the previous year's Maintenance and Support Fees.

(8) Payment of Maintenance and Support Fees.

(a) *Invoices.* Maintenance and Support Fees shall be invoiced annually in advance for the Initial Term or any Subsequent Term. Invoices for Maintenance and Support Fees shall be due and payable annually within thirty (30) days from the invoice date.

(b) *Subsequently Ordered CSI Software.* Maintenance and Support Fees for subsequently ordered CSI Software shall be paid as above but pro-rated for the applicable periods of this Agreement based upon the conclusion of the Warranty Period for such subsequently ordered CSI Software.

(c) *Failure of Payment.* In the event payment is not made as specified in this Agreement, Customer or Court shall pay interest at the rate of one and one-half percent (1.5%) per month (or the highest applicable legal rate, whichever is lower) on the outstanding overdue balance for each month or part thereof that such sum is overdue; *provided, however,* that if Customer or Court is a governmental agency or authority subject

to a "prompt payment" or similar statutory requirement for the transaction contemplated in this Agreement, such statutory requirement shall control to the extent the same is inconsistent with the requirements of this Section 8(c).

(9) Covered Maintenance.

(a) *General.* CSI shall provide to Customer or Court all required Covered Maintenance Services. All Conformity Maintenance Services and all Online Support and Telephone Support will be performed by CSI during the Basic Maintenance Period. Where such services will interfere with the functioning of the Customer's or Court's office during its regular hours, Conformity Maintenance Services and Online Support and Telephone Support will be provided at a time agreeable to both parties. Covered Maintenance Services do not include the costs of accessories and expendable supplies necessary to operate the CSI Software, such as magnetic tape cards, optical disks, disk packs, paper, and similar items, and such items are not provided free of charge by CSI hereunder.

(b) *Upgrade Maintenance Services.* As a part of this Agreement, Customer or Court shall also have the right to receive from CSI, without additional service charge, all Upgrade Maintenance Services. Upgrade Maintenance Services include the right to receive, during the applicable CSI Software Warranty Period and during the term of this Agreement (except as otherwise provided in Section 9(c) hereof), all Enhancements to the CSI Software, including all related update releases and associated Documentation. The right to receive Upgrade Maintenance Services does not include installation of any new release or any onsite training, and also does not include any new product, all of which are separately chargeable by CSI.

(c) *Support of Outdated CSI Software.* Support by CSI of previous versions of CSI Software will cease six (6) months following written notice by CSI to the Customer or Court of the availability of a new Version Release that is provided to Customer or Court by CSI. Support by CSI of previous versions of Embedded Third Party Software will cease in the time period provided for by the specific Embedded Third Party Software manufacturer. Failure of Customer or Court to install new Version Release's provided to Customer or Court by CSI or any other Defect correction or improvement provided by CSI or Embedded Third Party Software manufacturer within the allowed timeframe, shall relieve CSI of responsibility for the improper operation or any malfunction of the CSI Software as modified by any subsequent correction or improvement, but in no such event shall Customer or Court be relieved of any of its payment obligations to CSI hereunder, and CSI shall be released thereafter from its obligation to support the CSI Software. After failure to install in excess of the above allocated timeframe, in order for Customer or Court to return to current CSI Software release level and reinstate support, Customer or Court must obtain a CSI Software audit at then current CSI rates.

(d) *Online Support and Telephone.* Online Support and Telephone Support includes: (i) remote diagnostics; (ii) service desk and dispatch; (iii) question and answer consulting; and, (iv) non-chargeable user error remedies. A toll-free maintenance telephone number is provided for Telephone Support from CSI's corporate offices. Remote access is required at a minimum to one Customer or Court location for remote support, which remote access equipment is to be obtained by Customer or Court at its sole expense.

(e) *Exclusions.* Covered Maintenance Services does not include maintenance required by or the result of any: (a) operator error or improper operation or use of the CSI Software by Customer or Court; (b) modifications, repairs, or additions to the CSI Software performed by persons other than CSI, and Customer or Court shall notify CSI in writing of any such modifications, repairs, or additions; (c) modifications, repairs, or additions to Third Person Hardware or to any Third Person Software supplied by any person other than CSI; (d) damage to CSI Software by Customer's or Court's employees or third persons, including, without limitation, damage caused by improper operation or use of other software, hardware, or other equipment; (e) causes beyond the reasonable control of CSI, including, without limitation, any matter described in Section 14 (Excusable Delays) of this Agreement; (f) electrical disturbances, outages, brownouts, or similar events; (g) CSI's requested involvement in determining or solving a problem with the CSI Software and/or any other software, hardware, or equipment not covered by this Agreement; (h) damage to optical or magnetic media or any work effort associated with copying, reconstructing, or restructuring files or data; (i) damage resulting from radiation, radioactivity, ultraviolet light, or similar agents; (j) training services other than those expressly provided for without charge pursuant to the terms of the MSA; (k) CSI Software removed or detached from the Customer's or Court's network or system; or, (l) modifications made to the CSI Software or to any of the Specifications requested by Customer or Court. Travel costs incurred by CSI, with the prior written approval of the Customer or Court, including, without limitation, mileage, air fare, meals, lodging, and similar items for services performed by CSI outside the scope of the Covered Maintenance Services shall be the sole responsibility of Customer or Court.

(10) Response Times. CSI will respond within four (4) hours for standard support issues and within one (1) hour for system outage issues (but only during the Basic Maintenance Period) as calculated from CSI's receipt of a request or notice from Customer or Court of the need for Conformity Maintenance Services or CSI's receipt of a request or notice from Customer or Court for Online Support or Telephone Support to resolve such issues. Any such request or notice from Customer or Court will, to the extent possible, identify any Critical Defect, and, in connection with the provision of any Conformity Maintenance Service, Online Support, and/or Telephone Support, Customer or Court will, at its own expense, provide its full good faith support and cooperation with CSI's efforts at resolution. CSI will use its good faith efforts to correct any Critical Defect within twenty-four (24) hours after its receipt of the request or notice from Customer or Court regarding the applicable Critical Defect. Any Non-Critical Defect as agreed to by CSI and the Customer or Court will be corrected, before the earlier of: (a) thirty (30) days following the date of the next release (following notice of Defect from Customer or Court) of an Enhancement relating to the applicable CSI Software component; or, (b) six (6) months following notice of Defect from Customer or Court. In this instance of a Non-Critical Defect, CSI will provide the Customer or Court with interim alternative solutions, provided such is available to address such Non-Critical Defect. Support and Maintenance may be initiated by the Customer or Court outside of the Basic Maintenance Period and will be provided by CSI 24x7 on a best effort basis having the cost for such billed as provided for in Billable Call Maintenance.

(11) Billable Call Maintenance. Any maintenance service or related service or training other than Covered Maintenance Services will be charged at the rate of \$181.25 per hour, which rate will not exceed a 5% increase each year. Such rates apply to time spent performing maintenance, including travel time. The minimum charge for billable call maintenance is one-half

hour (1/2 hour). Should billable call maintenance services require travel to the Customer's site, travel costs, subsistence and lodging will be billed to Customer or Court at CSI's actual costs. All charges for billable call maintenance shall be due and payable within thirty (30) days following proper invoice by CSI. CSI shall provide an estimate and shall receive prior written approval of Court or Customer before beginning billable call maintenance services.

(12) Taxes. All Maintenance and Support Fees and all other charges payable hereunder are exclusive of federal, state, and local Taxes. If Customer or Court is tax exempt, it shall have no liability for taxes.

(13) LIMITATION OF LIABILITY. IN NO EVENT SHALL CSI OR CUSTOMER OR COURT BE RESPONSIBLE UNDER THE TERMS OF THIS AGREEMENT OR OTHERWISE FOR ANY INCIDENTAL, PUNITIVE, SPECIAL, OR CONSEQUENTIAL DAMAGES (INCLUDING, WITHOUT LIMITATION, LOSS OF DATA, LOSS OF PROFITS, AND/OR LOSS OF USE OF PRODUCT) EVEN IF ADVISED OF THE POSSIBILITY OF SUCH DAMAGES OR LOSS OF USE. IN NO EVENT WILL CSI'S LIABILITY RELATING TO THIS AGREEMENT FOR DAMAGES, UNDER ANY THEORY OF LIABILITY OR FORM OF ACTION, IN THE AGGREGATE FOR ALL CLAIMS EXCEED FIFTY PERCENT (50%) OF THE TOTAL AMOUNT OF THE MAINTENANCE AND SUPPORT FEES PAID BY CUSTOMER OR COURT TO CSI FOR THE TWELVE (12) MONTH PERIOD OF MAINTENANCE PRECEDING THE EVENT THAT CAUSED SUCH DAMAGES. THE LIMITATIONS OF LIABILITY HEREUNDER SHALL APPLY REGARDLESS OF THE FORM OF ACTION, WHETHER IN CONTRACT OR TORT, INCLUDING NEGLIGENCE WITH THE EXCEPTION OF WILLFUL MISCONDUCT, AND GROSS NEGLIGENCE. CUSTOMER, COURT AND CSI UNDERSTAND THAT THE FEES CHARGED OR AGREED TO BE PAID HEREUNDER SPECIFICALLY REFLECT THE ALLOCATION OF RISK AND EXCLUSION OF DAMAGES PROVIDED FOR IN THIS SECTION, AND THAT THE REMEDIES PROVIDED HEREUNDER ARE ADEQUATE.

(14) Excusable Delays. Notwithstanding any other term or provision hereof, neither party shall be liable for delays in delivery, failure to deliver, or otherwise to perform any obligation hereunder when such delay or failure arises from causes beyond the reasonable control of such party, including, without limitation, such causes as acts of God or public enemies, labor disputes, supplier or material shortages, hurricanes, public building closures on a county wide basis, embargoes, rationing, acts of local, state, or national governments or public agencies, utility or communication failures, fire, flood, storms, earthquake, settling of walls or foundations, epidemics, riots, terrorism, civil commotion, strikes, or war.

(15) Termination.

(a) *Termination at Will Upon Conclusion of Term.* During the Initial Term or any Subsequent Term of this Agreement, neither Party shall terminate this Agreement for reasons other than those expressly provided for in this Agreement; *provided, however*, that either Party hereto may terminate this Agreement at any time as of and effective at the conclusion of the Initial Term or any Subsequent Term upon written notice to the other Party given not later than ninety (90) days prior to the conclusion of the then current term of this Agreement. Notwithstanding such termination, if Customer or Court is not in default under this Agreement, and CSI elects to discontinue services by terminating this Agreement as set forth above, CSI must cooperate with Customer or Court by providing documentation, written technical materials and reasonable technical assistance as

necessary to ensure Customer's or Court's ability to continue to utilize the CSI Software so long as the MSA remains in effect. Customer or Court will warrant and agree to maintain the confidentiality of all materials and documentation.

(b) *Termination by CSI for Non-Payment or Upon Termination of License under MSA.* CSI may terminate this Agreement and its obligation to provide Covered Maintenance Services or any other service hereunder upon written notice to Customer or Court in the event Customer or Court fails to make any payment when due to CSI after thirty (30) days' notice of such failure to pay from CSI. This Agreement shall automatically terminate in the event the MSA or the subject Statement of Work is terminated upon the effective date of termination of the MSA and/or any subject Statement of Work. No termination pursuant to this subsection shall relieve Customer or Court of its accrued payment obligations to CSI up to the date of termination.

(c) *Termination by Customer or Court.* Customer or Court may terminate this Agreement for "cause" in accordance with this Section. For purposes of this Section, "cause" means a continuous, repeated, and substantial systemic failure of the CSI Software as identified and documented by the Customer or Court. In such event, the Customer or Court shall deliver written notice of its intent to terminate along with a description in reasonable detail of the problems for which the Customer or Court is invoking its right to terminate this Agreement under this Section. Following such notice, CSI shall have sixty (60) days to cure such problems. Following the sixty (60) day period, CSI and Customer and Court representatives will meet to discuss any outstanding issues. In the event that "cause" still exists at the end of such period, then the Customer or Court may terminate this Agreement. In the event of a termination under this Section, CSI shall return a portion of the Maintenance and Support Fees paid in advance by the Customer or Court to CSI on a prorata basis for the CSI Software directly involved with CSI's breach (based on the remainder of the term) and Customer or Court shall have no further obligations under this Agreement.

(d) *General Effect of Termination.* No termination of this Agreement shall relieve any Party hereto of any payment obligation that has accrued or been earned up to the date of termination, or shall terminate any right or remedy available to a Party as a consequence of any breach of this Agreement prior to the effective date of termination.

(e) *Reinstatement of Maintenance.* In the event this Agreement is terminated (except for an uncured breach by CSI), and then Customer or Court subsequently elects to obtain any CSI Software support services provided hereunder, such services will be available for CSI's current yearly fee, plus a one-time fee equal to the sum of all missed Maintenance and Support Fees, providing the Customer or Court has installed the most current Version Release of the applicable CSI Software.

(16) Miscellaneous Provisions. All applicable miscellaneous provisions in Section 21 of the MSA are hereby incorporated into this Agreement by this reference.

Exhibit B
CSI Confidentiality Agreement
(to be attached)

CSI CONFIDENTIALITY AGREEMENT

Sal, Johnson & Associates, Inc. d/b/a Computing System Innovations (“CSI”) has entered into that certain Master Services Agreement with [REDACTED] (“Customer”) dated [REDACTED] (the “MSA”) to provide certain proprietary software owned and developed by CSI (the “CSI Software” as also defined in the MSA) to Customer and other related services. Pursuant to the MSA, prior to providing anyone with access to the CSI Software, CSI Trade Secrets (defined below and in the MSA) or CSI Confidential Information (defined below and in the MSA), Customer has agreed under the MSA on behalf of CSI to have this CSI Confidentiality Agreement agreed to and executed by any third party being provided access to the CSI Software, CSI Trade Secrets or CSI Confidential Information. Therefore, before any access to the foregoing items is provided by Customer to [REDACTED] (“Consultant”), Consultant must agree to the following terms for the benefit of CSI.

Consultant may be provided and have access to certain CSI Software, CSI trade secrets (“CSI Trade Secrets”), CSI proprietary data, and other CSI confidential information (“CSI Confidential Information”) including but not limited to software documentation, UML diagrams, source code, object code, executable code, user interface design and functionality, user interface look and feel (excluding Customer data displayed), user processing workflows, methodology, programs, web services, templates, systems, databases, and database schemas in order to interface certain software to the CSI Software. In consideration of being provided with access to the foregoing items owned by CSI, Consultant hereby agrees to the following terms and conditions under this CSI Confidentiality Agreement on behalf of CSI:

1.0 Restrictions. Unless otherwise agreed to in writing by CSI, Consultant shall not:

- reverse engineer, de-compile, or disassemble any portion of the CSI Software, CSI Trade Secrets, or CSI Confidential Information;
- intercept and/or reverse engineer any CSI Software programmatic transactions, including but not limited to SOAP, REST, HTTP, or SQL transactions;
- add, change, delete data contained in any CSI Software databases without use of CSI Software application programming interfaces or CSI Software user interfaces;
- assign, transfer, rent, lease, time-share, or operate a service bureau using, the CSI Software, whether as a standalone or bundled product, for any reason, and any attempt to make any such assignment, delegation, rent, lease, sale, time-share, or other transfer by Consultant shall be void and of no effect;
- make copies of the CSI Software, CSI Trade Secrets or CSI Confidential Information;
- modify, translate, or create derivative works of the CSI Software, CSI Trade Secrets or CSI Confidential Information;
- remove any copyright, trademark, patent, or other proprietary notice that appears on the CSI Software, CSI Trade Secrets or CSI Confidential Information or copies thereof, or
- allow access to the CSI Software, CSI Trade Secrets or CSI Confidential Information to any third party.

2.0 Confidential Information. Consultant will not, without first obtaining CSI’s written consent, disclose to others for any purpose, or use (except for the benefit of CSI), CSI Software, CSI Trade Secrets, CSI Confidential Information except solely to integrate or interface certain Third Party Software (as defined in the MSA) with the CSI Software on behalf of Customer. Upon termination of the subject engagement between Customer and Consultant, Consultant will promptly turn over to Customer all then existing documents, source code, copies, and images (whether printed, electronic, or otherwise) made or acquired by Consultant which contain any CSI Software, CSI Trade Secrets or CSI Confidential Information. Consultant understands and acknowledges that all CSI Software, CSI Trade Secrets or CSI Confidential Information to which Consultant may be given access has been developed or obtained by CSI through the investment of significant time, effort and expense, and that items are valuable, special, and unique asset of CSI which provides CSI with a significant competitive advantage and which need to be protected from improper disclosure and improper use. Consultant shall inform its employees or representatives about the restrictions contained herein and Consultant shall ensure that its employees or representatives agree

to and strictly abide by the terms herein. Consultant hereby accepts full responsibility for any violations of the terms herein by such employees or representatives.

3.0 Governing Law. This CSI Confidentiality Agreement is governed by the laws of the State of Florida both as to interpretation and enforcement, without regard to conflict of laws principles.

4.0 Equitable Remedies. Consultant agrees that it would be impossible or inadequate to measure and calculate CSI's damages from any breach of the commitments set forth in this CSI Confidentiality Agreement. Accordingly, Consultant agrees that if Consultant breaches or threatens to breach any of such commitments, CSI or Customer (if agreed to in writing by CSI) shall be entitled to receive, in addition to any other right or remedy available, an injunction (permanent, preliminary, temporary, or otherwise) from any court of competent jurisdiction restraining such breach or threatened breach and to specific performance of any such provision of this CSI Confidentiality Agreement. Consultant further agrees that no bond or other security shall be required in obtaining such equitable relief and Consultant hereby consents to the issuance of such injunction and to the ordering of specific performance without bond or other security.

5.0 Enforcement. It is hereby acknowledged and agreed to by Consultant that CSI or Customer (upon CSI's written approval) has full right, authority and standing to enforce the provisions of this CSI Confidentiality Agreement.

6.0 Email/Fax Signatures. The undersigned acknowledges and accepts that any emailed or faxed signature shall be as legally binding as its signature upon an original.

The Consultant has executed this CSI Confidentiality Agreement as of the date written below.

Date: _____

_____, an individual [Sign immediately below if Consultant is an individual]

Consultant

_____ [Insert company legal name if Consultant is a legal entity and sign below]

By: _____

Print Name: _____

Title: _____

Exhibit C

State of Arkansas, Arkansas Supreme Court, Administrative Office of the Courts, Request for Proposals Image and Electronic Document Redaction, issued February 17, 2014 as amended March 12, 2014, attached as **Exhibit C**.

**State of Arkansas
Arkansas Supreme Court
Administrative Office of the Courts**

**Request for Proposals
Image and Electronic
Document Redaction**

NOTICE SEEKING PROPOSALS

Notice is hereby given that the State of Arkansas, Administrative Office of the Courts (AOC) is seeking proposals from qualified firms to provide a commercial off-the-shelf image and electronic document redaction solution for statewide implementation in the courts of Arkansas. The system must have the proven capability of redacting confidential information, including social security numbers, whether typed or handwritten. The system must be capable of redacting source files from a variety of DMS vendors where the source document may be stored in a word processing document, PDF, TIFF, and other file formats. The system must also be capable of employing optical character recognition of scanned images, and storing the redacted file in Adobe's Portable Document Format (PDF).

The work may consist of, but not be limited to, providing software, customization, integration with case management and document management systems, training, and ongoing maintenance services for the Redaction Project. Services provided under this contract may be required for a two-year period with an annual option to renew the contract.

1	KEY EVENTS AND DATES	5
2	GENERAL INFORMATION AND INSTRUCTIONS	6
2.1	Introduction	6
2.2	RFP Questions	6
2.3	Preparation of Proposal	6
2.4	Multi-Vendor Responses	6
2.5	Receipt of Proposals: Timeliness	7
2.6	Guidelines for Submission of Proposals	7
2.7	Proposals Signed	7
2.8	Opening	7
2.9	Format for Proposals	7
2.10	Alternate Proposals	7
2.11	Confidential Information	7
2.12	Contact Limitation	7
2.13	Proposal Constitutes Offer	8
2.14	Proposal Security	8
2.15	Competition	8
2.16	Vendor's Duty to Inspect and Advise	8
2.17	Amendments	8
2.18	Other Written Basis for Proposal	8
2.19	Notice of Award Posting	8
3	REDACTION PROJECT INTRODUCTION AND BACKGROUND	8
3.1	Redaction for the Arkansas Judicial Branch	8
	3.1.1 Case Management	9
	3.1.2 Electronic Filing	9
	3.1.3 Document Management	9
	3.1.4 System Integration Requirements	9
3.2	Project Goals	10
3.3	Vendor Relationship	10
4	OVERVIEW OF THE ARKANSAS JUDICIARY	10
4.1	Introduction	10
4.2	Appellate Courts	10
4.3	General Jurisdiction Courts – Circuit Courts	10
4.4	Limited Jurisdiction Courts – District Courts	11
5	VENDOR RESPONSE	11
5.1	Cover Letter	11
5.2	Executive Overview	11
5.3	Vendor Company Information	11
5.4	Project Plan and Methodology	11
5.5	System Features, Upgrades, and Future Functionality	11
5.6	Cost Proposal	11
6	SELECTION PROCESS	12
6.2	Demonstration or Customer Visits	13
7	VENDOR COMPANY INFORMATION	13
7.2	Organizational Background and Professional Qualifications	13
7.3	Vendor Profile	13
7.4	Qualifications	13

7.5	Product History	13
7.6	Installations.....	13
7.7	Staffing Plan	13
7.8	Customer Service Practices.....	13
7.9	Enhancements.....	13
7.10	Supplemental Information	13
7.11	Financial Information.....	14
	7.11.1 Status of Your Firm	14
	7.11.2 Financial Stability.....	14
	7.11.3 Failure to Complete Prior Projects.....	14
	7.11.4 Lawsuits	14
8	PROJECT PLAN & METHODOLOGY	14
8.1	Implementation Schedule/Work Plan	14
8.2	Project Plan Documentation.....	14
8.3	System Modification/Customization/Integration Plan.....	14
8.4	Initial Delivery Date	14
8.5	Training Plan & Schedule.....	14
8.6	Customer Service	15
8.7	Risk Assessment Methodology	15
9	SYSTEM FEATURES, UPGRADES, AND FUTURE FUNCTIONALITY.....	15
9.1	List and Description of System Features.....	15
9.2	Configuration, Reports, Code, Rule, Control Tables.....	15
9.3	File Formats, Multi-media Support, and Security.....	15
9.4	List and Description of Services	15
9.5	Review and Acceptance.....	15
9.6	Person Identification	15
9.7	System Architecture.....	15
	9.7.1 Execution Environment.....	15
	9.7.2 Performance, Scalability and Reliability.....	16
	9.7.3 Data Access/Privacy/Integrity	17
	9.7.4 System Security	17
	9.7.5 Development Environment.....	18
9.8	Minimum Requirements	18
9.9	Design Flaws	19
9.10	Ability to Satisfy Requirements of Administrative Order 19.....	19
9.11	Assumptions	19
9.12	Other Information.....	19
10	CONTRACTUAL OBLIGATIONS	19
10.1	The Contract Document	19
10.2	Patent and Copyright Liability.....	19
10.3	Ownership of Data	19
10.4	Compliance with Administrative Order 19	20
	10.4.1 Vendor will comply with Administrative Order 19 – Access to Public Records, Section X. Contracts With Vendors Providing Information Technology Services Regarding Court Records.	20
10.5	Force Majeure.....	20
10.6	Taxes.....	20
10.7	Waivers.....	20
10.8	Governing Law.....	20

10.9	Severability	21
10.10	Uniform Commercial Code.....	21
10.11	Uniform Computer Information Transactions Act.....	21
10.12	Affirmative Action.....	21
10.13	Technology Access.....	21
10.14	Indemnification.....	22
10.15	Liability for Damages	22
10.16	Compliance with Laws	23
10.17	Insurance.....	23
10.18	Licenses and Permits.....	23
10.19	Risk of Loss	23
10.20	Non-interference	23
10.21	Subcontractors.....	23
10.22	Assignment.....	23
10.23	Item Substitution	23
10.24	Contract Amendments, Modifications & Change Orders	23
10.25	Termination.....	23
	10.25.1 Notice of Termination.....	24
	10.25.2 Termination for Non-Appropriations.....	24
	10.25.3 Remedies of Vendor in Event of Non-appropriation	24
	10.25.4 Insolvency	24
	10.25.5 Termination for Convenience.....	24
	10.25.6 Termination for Cause	24
	10.25.7 Contract Violation.....	24
	10.25.8 Orderly Transfer of Materials	24
	10.25.9 Termination by Vendor.....	25
10.26	Software Licenses.....	25
	10.26.1 Software	25
	10.26.2 Source Code	25
11	APPENDIX MATTER.....	27
11.1	Court Technology Improvement Act – Act 328 of 2009	27
11.2	Administrative Order 19 – Access to Court Records	27
11.3	Information Technology Access for the Blind	27

1 KEY EVENTS AND DATES

1. Issuance of Specifications: **February 17, 2014**
2. Deadline for receipt of questions regarding this RFP: **March 7, 2014
5:00P.M. C.D.T.**
3. Deadline for receipt of proposals: **~~March 21, 2014~~
May 9, 2014
12:00 P.M. C.D.T.**

2 GENERAL INFORMATION AND INSTRUCTIONS

2.1 Introduction

In order to comply with the redaction requirement of the Arkansas Supreme Court under Section I.E. of Administrative Order 19, the State of Arkansas, Administrative Office of the Courts (AOC), invites proposals for systems and services for the implementation of a comprehensive statewide image and electronic document redaction solution for the Arkansas Judiciary.

The AOC is seeking proposals from qualified firms to provide a commercial off-the-shelf image redaction solution for statewide implementation in the courts of Arkansas. The system must have the proven capability of redacting confidential information, including social security numbers, whether typed or handwritten. The system must be capable of redacting source files from a variety of DMS vendors where the source document may be stored in a word processing document, PDF, TIFF, and other file formats. The system must also be capable of employing optical character recognition of scanned images, and storing the redacted file in Adobe's Portable Document Format (PDF).

The work may consist of, but not be limited to, providing software, customization, integration with case management and document management systems, training, and ongoing maintenance services for the Redaction Project. Services provided under this contract may be required for a two-year period with an annual option to renew the contract.

Section I.E. of Administrative Order 19 (Access to Court Records) provides that:

This order applies to all court records; however clerks and courts may, but are not required to, redact or restrict information that was otherwise public in case records and administrative records created before January 1, 2009. However, confidential information shall be redacted from pre-January 2009 case records and administrative records before remote access is available to such records.

2.2 RFP Questions

No vendor pre-proposal conference will be held. Instead, vendors may submit questions and requests for additional information about the RFP through the project website at **<http://courts.arkansas.gov/redactionrfp>**. The questions and answers will be posted to the project website. To submit questions or request additional information, submit your written question/request no later than the date and time shown in item 2 of section 1 above.

2.3 Preparation of Proposal

All proposals should be complete and carefully worded and must convey all the information requested. If significant errors or misrepresentations are found in the vendor's proposal, or if the proposal fails to conform to the essential requirements of the RFP, the AOC will be the judge as to whether that variance is significant enough to reject the proposal. The AOC reserves the right to accept or reject any parts of any proposals.

2.4 Multi-Vendor Responses

Multi-vendor responses (Joint Ventures) will be allowed only if one of the venture partners is designated as the "primary vendor". The "primary vendor" must be the joint venture's contact point for the State and be responsible for the joint venture's performance under the contract, including all project management, legal and financial responsibility for the implementation of all vendors' systems. If a joint venture is proposed, a copy of the joint venture agreement clearly describing the responsibilities of the partners must be submitted with the proposal. Multi-vendor proposals must be a consolidated response with all cost items included in the cost proposal. Where necessary, RFP response pages are to include information for each vendor.

2.5 Receipt of Proposals: Timeliness

A copy of the proposal must be submitted to and received by the AOC no later than the date and time specified in this RFP. Any proposals received after the deadline will be disqualified.

2.6 Guidelines for Submission of Proposals

Vendors are required to submit responses to this RFP in PDF format. Vendors must upload responses between 8 a.m. and 12 p.m. CST on March 21, 2014 on the project website at <http://courts.arkansas.gov/redactionrfp>.

2.7 Proposals Signed

Unsigned proposals will be rejected.

2.8 Opening

The AOC may open proposals as they are uploaded in response to this RFP after 8 a.m. on March 21, 2014.

2.9 Format for Proposals

Proposals are to be prepared in a manner designed to provide the AOC with a straightforward presentation of the vendor's capability to satisfy the requirements of this RFP. It should be contained in a single PDF file. All documentation submitted with the proposal should be included in that single PDF where practical. Because the proposal is a contract document, hyperlinks to information intended to be a part of the proposal that are external to the PDF are not permitted. Internal hyperlinks to information contained in the proposal are permitted. Vendors shall explain in detail the method used to meet each requirement. Elaborate brochures and other promotional materials are not desired.

2.10 Alternate Proposals

Vendors may submit more than one proposal, each of which must satisfy the requirements of this RFP in order to be considered. The alternate proposal(s) must be labeled "Alternate Proposal", and should address all the requirements of the RFP or specify those portions that the alternate proposal would address, signifying that all other requirements would be accomplished as set forth in the RFP.

2.11 Confidential Information

The AOC will not present, or otherwise make available, any documents relating to this procurement to any other person, agency or organization, other than those evaluating proposals for purpose of award, until notification of intent to award. Trade secrets or proprietary material shall not be disclosed if appropriately marked. The first page of the proposal must be marked to denote whether proprietary information is contained in the documents. The proprietary or trade secret material submitted must be identified by some distinct method such as highlighting or underlining and must indicate only the specific words, figures, or paragraphs that constitute trade secret or proprietary information. The AOC may not be held liable for disclosing confidential information that is not marked according to these guidelines. **The classification of an entire proposal document, line item prices or total proposal prices as proprietary or trade secrets is not acceptable and will result in rejection of the proposal.**

2.12 Contact Limitation

During the period following issuance of the proposal and prior to the statement of intent to award, vendors intending to respond to the RFP shall not directly or indirectly initiate any

contact regarding this RFP with the AOC or the Supreme Court, other than that permitted in section 2.2 above. Contact in violation of this section will disqualify the vendor.

2.13 Proposal Constitutes Offer

By submitting a proposal, the vendor agrees to be governed by the terms and conditions as set forth in this document and any subsequent amendment. Proposals shall be valid at least through August 29, 2014.

2.14 Proposal Security

In order to assure full performance of all obligations imposed on a vendor by contracting with the AOC, within ten (10) working days from the date of the vendor's receipt of the AOC's notification of its intent to award a proposal, the successful vendor may be required to provide a performance security in an amount equal to the contract price submitted by the vendor and accepted by the AOC that shall be valid at least until system acceptance.

The form of security required shall be a performance bond such as is usually and customarily written and issued by surety companies licensed and authorized to do business in Arkansas or a cashier's/certified check or irrevocable letter of credit from an Arkansas bank.

2.15 Competition

It is the vendor's responsibility to advise the AOC if any language, requirements, or any combination thereof, inadvertently restricts or limits the requirements stated in this RFP to a single source.

2.16 Vendor's Duty to Inspect and Advise

Each vendor shall fully acquaint itself with the scope of this RFP. The failure of a vendor to acquaint itself with existing pre-contract conditions or post-contract consequences shall in no way relieve such vendor of any obligation with respect to this proposal or to any resulting contract.

Vendors must notify the AOC of all costs reasonably expected. Vendors are notified that their failure to inspect, familiarize themselves with, or otherwise gather information as to the total cost to the AOC, will, in addition to any other remedies available, create cost difference liabilities and claims against the vendor.

2.17 Amendments

If it becomes necessary to revise any part of the RFP, the AOC will issue a written amendment.

2.18 Other Written Basis for Proposal

If any of the vendor's proposal has as its basis written statements (other than the RFP) provided by the AOC (such as notification of a change in the specifications), the vendor is to identify and include those statements in its proposal at the place or places applicable.

2.19 Notice of Award Posting

Notice of Award or Intent to Award will be posted at <http://courts.arkansas.gov>.

3 REDACTION PROJECT INTRODUCTION AND BACKGROUND

3.1 Redaction for the Arkansas Judicial Branch

Access to Arkansas court records is governed by Administrative Order Number 19. In 2013, the order was amended to require that confidential information in electronic documents filed prior to 2009 be redacted before allowing online remote access to the documents. See <http://opinions.aoc.arkansas.gov/weblink8/ElectronicFile.aspx?docid=316757&dbid=0>. In order to satisfy the redaction requirement and to permit online remote access to pre-2009 court documents, the Administrative Office of the Courts has begun a project to select and implement an image and electronic document redaction solution for all Arkansas courts.

3.1.1 Case Management

The AOC is currently implementing a modified version 5.2 of the Contexte case management system from Xerox. The system has been deployed in the Supreme Court and Court of Appeals, in circuit court in 32 of Arkansas's 75 counties, and 8 district courts. The AOC has active implementation projects and project requests in another 26 counties including 4 district courts.

The AOC provides online public access to court information using the Xerox CourtConnect web interface (website: <https://caseinfo.aoc.arkansas.gov>). The public is able to locate information about court filings. If the court is using one of the integrated DMS solutions, and if the court has made remote access to documents available, CourtConnect includes hyperlinks to the local DMS to deliver images of court documents to the public through a web browser.

3.1.2 Electronic Filing

In March 2013, after a one-year pilot project, electronic filing became mandatory for attorneys in the Pulaski County Circuit Court. The AOC is implementing the Tybera eFlex electronic filing solution and will begin rolling out the solution to other courts in 2014.

3.1.3 Document Management

Arkansas is a non-unified judiciary with locally elected circuit clerks and judges. District court clerks are local government employees serving at the pleasure of the district judge. Because the clerks are responsible for court records, the AOC did not provide a centralized document management system solution as the case management system was being deployed.

As part of the appellate court Contexte implementation project, the AOC utilized the integrated imaging functionality of Contexte to store document images in the Contexte Oracle database. After being stored in the database, the image is copied to a local Laserfiche DMS (<http://www.laserfiche.com>), which is also used for publishing the opinions of the appellate courts.

As part of the electronic filing project, the eFlex software was integrated with the DocsServer solution from Dynamic Information Solutions Company, Inc. (D.I.S.C.) (website: <http://www.discllc.com>), which has also been integrated with Contexte. However, in order to facilitate the rollout of electronic filing, future eFlex implementations will use the centralized integrated Contexte image repository for document storage, and, as with the appellate project, make copies of the images available to the courts for storage in a local DMS. For each eFiling implementation, the AOC expects to retrieve images from the court's local DMS and store them in the central image repository. At go-live for eFiling, all scanned and electronically filed documents will first be converted to PDF then stored in the central Contexte repository. Subsequently eFiled or scanned documents will be stored in the Contexte repository then a copy will be made available for storage in a local DMS.

In addition to the DISC DMS, Contexte has been integrated with a DMS from Apprentice Information Systems (website: <http://www.apprenticeis.com>) and a DMS from Fidlar Technologies (website: <http://fidlar.com>). The AOC will not be integrating Contexte with other DMS vendors; however, courts are using other DMS systems, and it is within the scope of this RFP to permit courts using other DMS systems to utilize a contract resulting from this RFP to redact images in order to make them available online to the public.

3.1.4 System Integration Requirements

Because the burden of ongoing redaction is placed upon attorneys and filing parties, there is no anticipated need for an ongoing redaction solution for newly filed documents. However, many courts are engaged in projects to scan back files of court records, so the solution must be capable of interactive redaction of newly scanned historical documents in addition to redacting a repository of previously scanned court documents. The redaction capabilities of

the various DMS used by the courts are unknown, so the extent of use of the redaction solution resulting from this RFP is also unknown.

3.2 Project Goals

The overall goal of the Redaction Project is to permit online remote public access to court documents consistent with the redaction requirements of Administrative Order Number 19.

The successful implementation of the redaction project will result in the following:

- redaction of electronic documents currently stored in the central Contexte database;
- redaction of documents when delivered to the AOC for storage in the Contexte repository as part of an electronic filing implementation;
- a state contract that will allow courts to purchase the services of the vendor for redaction of electronic documents currently stored in local DMS repositories;
- a state contract that will allow court users to purchase vendor software or services to be able to interactively redact documents as part of an historical back-file scanning project.

3.3 Vendor Relationship

The AOC anticipates the formation of a close partnership with the selected vendor to achieve our goals and which will result in a long-term business relationship that is beneficial to both parties. The AOC seeks a vendor that will be a long-term partner, will be able to provide enhancements to the redaction system over time, and will be able to introduce the latest proven technologies as they become available.

4 OVERVIEW OF THE ARKANSAS JUDICIARY

4.1 Introduction

The judicial branch of the State of Arkansas has recently undergone significant changes as a result of the passage of the 80th Amendment to the Constitution of Arkansas. The Arkansas Supreme Court is working to take advantage of this judicial branch reorganization and improve the judiciary's business processes by implementing statewide the Xerox Contexte case management system integrated with the Tybera eFlex electronic filing solution.

Arkansas has a non-unified, three-tier system of courts of appellate, general and limited jurisdiction. The Administrative Office of the Courts has a Court Information Systems Division that has grown from 11 to 68 employee and contractor positions since the court automation project began in 2002. The CIS Division is responsible for assisting in the technology needs of the Supreme Court, the Court of Appeals, and for providing technical guidance to all levels of courts within the State. The division is responsible for implementation and maintenance of the Xerox jury and case management systems and the Tybera eFlex electronic filing solution being deployed in Arkansas courts.

Caseload information for Arkansas courts is available online from the Arkansas Judiciary website at the following address:

<https://courts.arkansas.gov/forms-and-publications/annual-reports>

The Arkansas Court Structure Diagram is available at the following address:

<https://courts.arkansas.gov/sites/default/files/Arkansas%20Court%20Structure.pdf>

4.2 Appellate Courts

The Arkansas Supreme Court has one chief justice and six associate justices elected statewide for eight-year terms. In addition to its appellate jurisdiction, the Court has general superintending control over all courts in the State of Arkansas. The Court of Appeals is composed of 11 judges and one chief judge elected from judicial circuits for eight-year terms.

4.3 General Jurisdiction Courts – Circuit Courts

The 75 counties of Arkansas are divided into 28 judicial circuits, with 121 elected circuit judges. Each circuit judge has at least one trial court assistant and a court reporter, who are all state employees. Each county in the judicial district has a courthouse, and nine counties

have two courthouses, for a total of 84 courthouses statewide. The circuit clerks are elected county officials. In most counties the county clerk is the ex-officio circuit clerk for the probate division.

Pursuant to the Supreme Court's Administrative Order 14 the circuit courts divide their caseloads into five subject matter divisions: criminal, civil, juvenile, probate, and domestic relations. "Probate" means cases relating to decedent estates, trust administration, adoption, guardianship, conservatorship, commitment, change of name, and adult protective custody. "Domestic Relations" means cases relating to divorce, annulment, maintenance, custody, visitation, support, paternity, and domestic abuse. Circuit courts also serve as appellate courts. Cases tried in district court may be appealed to circuit court for a trial *de novo*.

4.4 Limited Jurisdiction Courts – District Courts

District courts have the highest caseload of Arkansas courts. Most cases are uncontested traffic cases. The district courts also hear small claims and civil cases, and have jurisdiction over misdemeanor criminal cases. There are 84 district courts in 238 departments with 110 judges.

5 VENDOR RESPONSE

5.1 Cover Letter

The proposal must be accompanied by a cover letter, signed by an individual authorized to bind the proposing entity.

5.2 Executive Overview

The vendor should include an executive overview of its organization, the benefits it brings to this project, its approach to this project, any partnering and subcontracting arrangements that it expects to use in fulfilling this contract, and any additional noteworthy information. In this section the vendor must provide a narrative of what is being proposed. The narrative should include the following items:

- The vendor should describe how the product(s) proposed best meet the State's needs and why the vendor recommends that the State select the product(s).
- The vendor should provide information on any competitive advantage the proposed product has over the competition.
- The vendor should provide a brief overview of the support and maintenance services it provides.

5.3 Vendor Company Information

In this section vendor is required to provide the information requested in Section 7 below.

5.4 Project Plan and Methodology

In this section vendor is required to provide the information requested in Section 8 below.

5.5 System Features, Upgrades, and Future Functionality

In this section vendor is required to provide the information requested in Section 9 below

5.6 Cost Proposal

A person authorized to bind the company should sign the vendor's proposal and include the following statement: "I hereby certify that the prices included in this proposal are accurate and binding and that all costs are shown and accurately reflect my total proposal cost."

Vendors may submit multiple cost proposals.

There are two categories required for the cost proposal:

1. The cost to AOC for software and services to meet the first two project goals:
 - redaction of electronic documents currently stored in the central Contexte database;
 - redaction of documents when delivered to the AOC for storage in the Contexte repository as part of an electronic filing implementation;

2. The cost for individual courts should they desire to engage the vendor to meet the second two project goals:
 - a state contract that will allow courts to purchase the services of the vendor for redaction of images and electronic documents currently stored in local DMS repositories;
 - a state contract that will allow court users to purchase vendor software or services to be able to interactively redact documents as part of an historical back-file scanning project.

The AOC reserves the right to select specific line items of the vendor's proposal. For each of the two categories, the cost proposal should at least address the following:

- Describe your approach to charging for software licensing, and list the software license cost for statewide implementation of the system in all courts in all counties. Because of limited funding and the inability to determine the extent of the need for the software in courts using a DMS, vendors are encouraged to be creative in proposing ways to manage the cost, such as graduated per-seat licensing as the number of available courts utilizing the software increases.
- Describe your approach to charging for redaction of image repositories and the degree to which court personnel would be required to be involved.
- Describe your approach to charging for annual maintenance.
- Describe your approach and charges associated with integrating the redaction solution with document management systems and the Xerox Contexte case management system.
- Provide time and materials rates for software modifications.
- List the cost for any third-party software licenses needed, including database software and operating systems for the proposed solution and include the ongoing maintenance of these licenses. The AOC reserves the right to purchase third-party software directly from its source.
- List any additional costs for software escrow services if applicable.
- List customer service options and their associated costs.
- List training options and their associated costs.
- List any other miscellaneous costs that may be required.
- If your proposed system requires hardware from a specific vendor, please list the costs associated with this hardware.

6 SELECTION PROCESS

Each response will be reviewed to determine if it meets the minimum contractual and technical RFP requirements. Any proposal failing to meet these requirements will be deemed non-responsive and eliminated from further consideration.

Vendors will be evaluated on the demonstrated ability of the system to perform OCR on scanned documents and successfully redact confidential information.

Executive summary and vendor company information are important evaluation criteria as the State intends to identify a redaction solution "partner". Apparent financial stability of proposing suppliers will be measured relative to their ability to meet commitments made during their proposals.

Vendors will be evaluated based upon their proposed project plans and methodology, and their demonstrated ability to successfully complete projects on time and on budget.

Vendors will be evaluated based upon their ability to meet the specific needs and requirements and the ability to satisfy the requirements of Administrative Order Number 19.

The cost evaluation will be based on the total projected cost for the Redaction Project including: licensing, customization, installation, required hardware, services for redacting image repositories, software products and on-going maintenance and support.

6.2 Demonstration or Customer Visits

If multiple vendors satisfy the requirements and project goals and provide viable cost proposals, the AOC reserves the right to invite selected vendors to conduct demonstrations to assist in the decision whether to award a contract. The AOC may, at its discretion, conduct customer visits to view successful redaction implementations.

7 VENDOR COMPANY INFORMATION

7.2 Organizational Background and Professional Qualifications

If you are submitting a multi-vendor response, provide the below listed items for each vendor.

7.3 Vendor Profile

Provide a statement giving a brief history of your organization, how it is organized, and how its available resources will be utilized to meet the State's requirements.

7.4 Qualifications

Briefly provide information that highlights your organization's particular abilities to successfully complete the State's requirements and how you would structure, develop, and manage the project.

7.5 Product History

Describe the history of your solution, including: initial release date, current version number, development history (e.g., was it developed as a marketable package, or as a solution for a particular organization), and the environments to which it has been ported. Please provide a list of case management systems and document management systems with which the system has been successfully integrated.

7.6 Installations

Provide a complete list of your customers for the past five years who have used or are using the product or similar services to those proposed in your response to this RFP, including contact names, addresses, and phone numbers. Indicate whether these are single or multi-jurisdictional installations. Also include the components and product version number each customer currently uses and the corresponding implementation date. Provide date and reason for contract termination, if applicable.

7.7 Staffing Plan

Provide your company's staffing plan for the next three years.

7.8 Customer Service Practices

Provide a statement explaining your customer service practices, including hours of operation, call prioritization system, response times for each level of priority call, number of staff assigned, and location of support. Also include historical information or estimates of the number and duration of customer service calls you receive on a periodic basis (daily, weekly, or monthly).

7.9 Enhancements

Describe the process by which system enhancement opportunities are identified, screened, programmed, tested and released to users.

7.10 Supplemental Information

Provide any supplemental information that you think will be valuable to the State in evaluating your qualifications and personnel regarding your ability to meet the State's requirements.

7.11 Financial Information

7.11.1 Status of Your Firm

If a corporation, list the state and date of incorporation. If other than a corporation, list all general partners, joint ventures and persons or entities with an interest of ten percent (10%) or more in the company, indicating the title, if any, and the percentage of the interest of each.

7.11.2 Financial Stability

Provide proof of your financial stability (e.g., corporate financial statement for the last 5 years).

7.11.3 Failure to Complete Prior Projects

Disclose whether your organization (or any general partner or joint venture thereof) has ever failed to complete an electronic filing project. If so, list the date of commencement of the project and the entity for which the project was to be performed, and explain why the project was not completed.

7.11.4 Lawsuits

Disclose any lawsuits that have been brought against your company in the last five years in relation to the product or similar services to those proposed in the vendor's response to this RFP. Vendors shall list the status of each lawsuit and any outcomes that have occurred.

8 PROJECT PLAN & METHODOLOGY

Provide your proposed plan for providing the functionality desired by the State including:

8.1 Implementation Schedule/Work Plan

Describe your implementation planning process in general. Describe the roles your company will play in implementation and the roles the courts' and State's employees will play. Provide details of your approach to project management.

8.2 Project Plan Documentation

Provide a typical high-level single court implementation schedule listing vendor resources to be deployed, required court and State resources and any other resources that may be assigned to tasks in the project plan. The schedule should include project milestones with target dates measured from project start date. The winning vendor will be expected to work with the AOC project management group to develop a detailed pilot project plan consisting of tasks, start and end dates, assignees, dependencies and status prior to project kick-off.

8.3 System Modification/Customization/Integration Plan

Assuming that your product will require some customization and integration with case and document management systems for deployment in Arkansas, describe your approach to system customization and integration. Include a statement of how the State should request product customizations or enhancements, how they will be delivered, how customization effort is estimated, and any other pertinent information.

Describe the process by which you decide whether a modification will be made to your base package, or whether the modification is a custom modification. Explain the impact product upgrades will have on custom modifications. Describe the Quality Assurance/Testing processes you follow for determining whether an upgrade or custom modification is suitable for release.

8.4 Initial Delivery Date

Indicate the earliest date on which you could deliver your off-the-shelf product and services, and begin implementation. Also include a range of subsequent possible implementation dates, in the event that the State is unable to begin implementation on your earliest delivery and implementation date.

8.5 Training Plan & Schedule

Describe in detail your proposed training plan (both initial and on-going) for users, system administrators, and AOC and court staff. Describe your approach to end-user training and any training you will provide to AOC and court staff. Discuss whether training will occur remotely, on-site, or out-of-state, and what resources the State or court will be required to provide for training.

8.6 Customer Service

Describe your proposed customer service plan, including expected response times broken down by priority levels, hours of operation and emergency availability, and services included and excluded. If alternate plans exist, please explain in detail. Explain to what extent the plan supports databases and software, client applications, system administration and operations scripts and utility programs that are vendor-produced or vendor-supplied third-party tools. Explain the State's responsibilities with respect to support.

8.7 Risk Assessment Methodology

Describe your risk assessment and mitigation methodology and how you would apply it to the implementation of your solution.

9 SYSTEM FEATURES, UPGRADES, AND FUTURE FUNCTIONALITY

Proposals shall explain in a written narrative how their proposed systems address the following issues regarding system features, upgrades, and future functionality. Proposals that do not provide this information will be considered unresponsive and will be excluded from further participation in the evaluation process.

9.1 List and Description of System Features

Provide a list and description of system features.

9.2 Configuration, Reports, Code, Rule, Control Tables

Describe the process for configuring your solution for implementation in a multi-jurisdictional court system. Provide a list and copies of all predefined reports, code, rule, and control tables. Include any mechanisms available for versioning codes (such as begin/end dates).

9.3 File Formats, Multi-media Support, and Security

List the file formats supported for redaction by the system.

9.4 List and Description of Services

Provide a list and description of services available should the court wish to deliver a repository of images for redaction.

9.5 Review and Acceptance

Describe the process used by the clerk to review and accept or reject redactions during an interactive redaction process.

9.6 Person Identification

Describe your approach to identifying information that is to be redacted.

9.7 System Architecture

9.7.1 Execution Environment

- Describe the platform(s) on which your solution runs. Provide an overall execution architecture topology diagram(s) that represents the platforms that your system uses, the software components on each platform and the connections and protocols between each platform. Include a statement regarding your recommended technical environment, being specific about network, server, and workstation requirements.
- Describe which operating systems are supported for each platform (include versions supported). Include what percentage of your installed base is using each operating system in production today. Provide a statement explaining the technical

environments in which you have implemented your product for other customers and the number of each.

- For each operating system supported, provide your minimum and recommended CPU, RAM and hard drive requirements and upon what assumptions these minimum and recommended requirements are based.
- Describe which modules or components come with your base product. Please indicate which additional components are available.
- List any pre-requisite software required for implementation on each of the platforms.
- Describe any other application packages that are inherent in the software that will require contracting from a different vendor.
- List protocols or middleware products used for communications between platforms or tiers.
- If a third-party application server is used in your solution, indicate the product or products that are used.
- Describe the database platform if applicable. State whether the database is specific to the product and whether the database can be customized and how.
- Describe the design of your error handling. Describe what happens in the case of an error; how errors are logged and how they are resolved, including how they are communicated to the client.
- Describe external interfaces that exist in your solution. Describe the method used to access data or applications within the solution from an external application. State what type of application program interfaces (API's) exist for providing this interface. (An example might be an inline redaction process that conducts OCR and redaction on a non-redacted image in a database prior to delivery to the requesting user's web browser).
- If integration with e-mail, fax, other text messaging products, or word processing or spreadsheet programs is included in the solution, indicate the products with which it interacts and explain how your product interfaces with these solutions.
- If integration with multimedia products is included in your solution, indicate the products with which it interacts and explain how your product interfaces with these solutions.
- Describe any system maintenance functions that cannot be completed while the system is in full operation.
- Describe how your system integrates with document management systems and the process for integrating with a new document management system.
- Describe whether and to what degree your system will integrate with the Xerox Contexte case management system.

9.7.2 *Performance, Scalability and Reliability*

- List the key factors that drive the solution's performance and what tools/capabilities exist to tune the performance.

- Identify any limitations related to transaction volumes.
- Describe current SLA's (Service Level Agreements) that are used with your clients. Make sure system availability is addressed.
- Describe your performance benchmarking. Please provide supporting documentation on your benchmarking methods.
- Describe your largest installation (number of concurrent users, transaction volumes, performance, response times, image database size, number of sites and distance between sites, etc.).
- Identify the maximum number of concurrent users doing update, query and reporting that your solution can support, and identify the architecture components that impose these limitations.
- Describe how one would scale the current application and describe the additional infrastructure upgrades to your system requirements that would be necessary to accomplish it. Describe actual episodes, including the outcome, where you have had to scale the platform for your customers.
- Describe the means of monitoring application performance and any ability to place alerts on critical measures.
- Explain whether your solution would meet an uptime requirement of 99.7%, and whether your system is available to clients on a 24x7 basis.

9.7.3 *Data Access/Privacy/Integrity*

- Describe your approach to data security. State how you ensure that data is secure from unauthorized access by internal employees and external entities.
- Describe how concurrent updates to a single record are prevented.
- Describe your data access design, giving particular attention to transaction management.

9.7.4 *System Security*

- Describe the user administration process required for your product.
- Identify the different levels of security that are available. Security must be based on any combination of data element value, transactions type (e.g., add, update), application level (e.g., catalog, sub-catalog), user ID (e.g., individual, group, manager) or device ID (terminal or workstation that the user is working on).
- List any audit reports you provide. Identify the key report fields such as element, user ID and timestamp. Describe how the reports can be used to identify security violations and data corruption. Also, list any other security reports that are available, such as password violation reports or active user list.
- Describe encryption technologies used by your product.
- Describe the user registration, password reset, and new user creation process.

9.7.5 *Development Environment*

- Describe your development methodology and development team structures. State what quality and process improvement programs are in place. State whether there have been any assessments of the development process (e.g., SEI or ISO).
- Describe your code management process. Include your versioning strategy and how often new versions of your solution come out. State whether you do point fixes or whether all fixes are packaged into the next release. Explain whether, if point fixes/patches are made for one client, that affects another client. Describe your process for releasing a new version of the software.
- Describe the maintenance (bug fixing) process used. Include who is responsible for the maintenance of the system, and how you track issues/bugs communicated to you by your clients. Explain your policy regarding correcting these bugs. State how quickly bug fix requests are fulfilled, and how these corrections are communicated to the client. Describe the process and policy for client installation.
- State how many developers are dedicated to development and how many to bug fixes. Describe how you deal with version changes to third party software, including database and operating system software, and your policy for adopting them.
- Describe the development tools used to create your product, including programming language(s), report writers, etc.
- Discuss how the solution can be interfaced to other systems. Include a discussion of any tools or API's that exist to support the creation of interfaces to external systems.

9.8 **Minimum Requirements**

Indicate whether and to what degree the proposed solution meets the following requirements:

- The software is configurable, rules-based software that can be configured by AOC to keep current with changes to Arkansas redaction requirements.
- Redacted information is permanently removed from the document, not merely masked or covered up, and a new document is created.
- All redacted images retain an accuracy rate of 98% or better with less than 1% false positive redaction return.
- The software solution allows the ability to either auto-redact or OCR+1 manual review with images flagged with definite and suspect redaction candidates.
- The software allows for manual redaction as ordered by the court.
- The software has the ability to create both a redacted and non-redacted version of the image.
- The software is able to read and redact both machine printed and handwritten images and unstructured data.
- When redaction rules are changed, the redaction software can examine all existing files and identify where redaction is necessary.
- The final format of redacted images is a searchable pdf and meets ADA compliancy standards.
- If the solution requires an installation on each client machine, the software is updateable without physically touching each client.
- The system is interoperable with any standards-based content or document management system
- The system is able to rapidly recognize or "fingerprint" document types based on previous examples.
- The system is able to extract and classify documents based on those recognized types.

- The system is able to read bar codes or QR codes inherently with no additional cost or modules.
- The system has a powerful one-pass OCR engine that allows both the capture of metadata, indexing, classification and redaction information.
- The system allows for configurable watermarking/stamping of selected documents.
- The system is able to, from a single pass, output two or more redacted versions based on different rules.
- The system provides a forensic audit trail of redactions or changes made to the document.
- The system is able to output to PDF/ Searchable PDF / PDFa / multi-page TIFF.
- The software is able to identify and redact both horizontal and vertical text.

9.9 Design Flaws

State any product design flaws, faults, or omissions of which you are aware. State the status of any solutions to these.

9.10 Ability to Satisfy Requirements of Administrative Order 19

The system must comply with all legal requirements of Administrative Order Number 19. Please describe any system deficiencies that do not comply and the plan for remediation of the deficiencies.

9.11 Assumptions

Clearly state any assumptions you made in preparing your proposal.

9.12 Other Information

Provide additional pertinent information not specifically addressed by this document, including features, documentation, and limitations.

10 CONTRACTUAL OBLIGATIONS

10.1 The Contract Document

Any contract resulting from this solicitation shall consist of the following documents which are listed in order of precedence: (1) any amendment required to resolve any difference between the remaining documents, (2) contract between AOC and vendor, (3) any amendments to the original solicitation in reverse order of issuance, (4) the solicitation as issued by the AOC, (5) any amendments to the successful vendor's proposal accepted by the AOC, (6) the vendor's proposal.

10.2 Patent and Copyright Liability

If notified promptly in writing by the AOC of any action (and all prior claims relating to such action) brought against the State of Arkansas, based on a claim that the State's use of the services or products offered, including software, infringes a United States patent or copyright, the vendor will defend such action at its expense and will pay the costs and damages awarded in any such action. The AOC shall give the vendor prompt written notice of such claim and full right and opportunity to conduct the defense thereof, together with full information and reasonable cooperation. No cost or expenses shall be incurred for the account of the vendor without its written consent. If principles of government or public law are involved, the State of Arkansas may participate in the defense of any action. If, in the opinion of the vendor, the products furnished hereunder are likely to, or do become, the subject of a claim of infringement of a United States patent or copyright, then, without diminishing its obligation to satisfy a final award, the vendor may, at its option and expense, (a) obtain the right for the State to continue to use such goods; or (b) substitute for the alleged infringing products other equally suitable products that are satisfactory to the AOC; or (c) take back such products; provided however, that the vendor will not exercise option (c) until the vendor and the AOC have evaluated options (a) and (b). In such event, vendor will reimburse the AOC for the purchase price of any goods removed pursuant to option (c).

10.3 Ownership of Data

All data and other records entered into any databases of the State or a court or supplied to the vendor by the State or court are, and shall remain, the sole property of the State or court. Vendor shall not copy or use such records without the owner's written consent except to carry out contracted work, or transfer or disclose the contents of such records to any other party not involved in the performance of this agreement.

10.4 Compliance with Administrative Order 19

10.4.1 Vendor will comply with Administrative Order 19 – Access to Public Records, Section X. Contracts With Vendors Providing Information Technology Services Regarding Court Records.

- A. If a court, court agency, or other private or governmental entity contracts with a vendor to provide information technology support to gather, store, or make accessible court records, the contract will require the vendor to comply with the intent and provisions of this access policy. For purposes of this section, the term 'vendor' also includes a non-judicial branch state, county or local governmental agency that provides information technology services to a court.
- B. Each contract shall require the vendor to assist the court in its role of educating litigants and the public about this order. The vendor shall also be responsible for training its employees and subcontractors about the provisions of this order.
- C. Each contract shall prohibit vendors from disseminating bulk or compiled information, without first obtaining approval as required by this order.
- D. Each contract shall require the vendor to acknowledge that court records remain the property of the court and are subject to the directions and orders of the court with respect to the handling and access to the court records, as well as the provisions of this order.
- E. These requirements are in addition to those otherwise imposed by law.

10.5 Force Majeure

Vendor shall not be liable for any damages resulting from any delay in delivery, or failure to give notice of delay, which directly or indirectly results from the elements, acts of God, delays in transportation, or delays in delivery by any cause beyond the reasonable control of the vendor. The delivery schedule may, upon the prior written request of the vendor, be extended by a period of time equal to the time lost because of such delay.

10.6 Taxes

Prices are to be exclusive of all sales, use, and like taxes. Any tax the vendor may be required to collect or pay upon the sale, use or delivery of the products shall be paid by the AOC, and such sums shall be due and payable to the vendor upon acceptance. Any personal property taxes levied after delivery shall be paid by the AOC. It shall be solely the AOC's obligation, after payment to vendor, to challenge the applicability of any tax by negotiation with, or action against, the taxing authority. Vendor agrees to refund any tax collected which is subsequently determined not to be proper and for which a refund has been paid to vendor by the taxing authority.

In the event that the vendor fails to pay, or delays in paying, to any taxing authorities, sums paid by the AOC to vendor, vendor shall be liable to the AOC for any loss (such as the assessment of additional interest) caused by virtue of this failure or delay. Taxes based on the vendor's net income or assets shall be the sole responsibility of the vendor.

10.7 Waivers

No waiver of right, obligation, or default shall be implied, but must be in writing, signed by the party against whom the waiver is sought to be enforced. One or more waivers of any right, obligation, or default shall not be construed to waive any subsequent right, obligation, or default.

10.8 Governing Law

Vendor consents to be governed by Section 19-11-246 of the Arkansas Code Annotated and agrees that Section 19-11-246 applies to and governs the agreement. Vendor waives any objection it may have now or hereafter to the administrative process required by Section 19-

11-246. To the extent that Section 19-11-246, by its own terms, does not govern a claim or controversy arising out of or relating to the agreement, vendor agrees that any suit, action or proceeding arising out of or relating to the agreement shall be instituted and maintained only in a state or federal court located in Pulaski County, State of Arkansas. Notwithstanding any other agreement between vendor and the State, the agreement shall be governed by and construed in accordance with the laws of the State of Arkansas, and any suit, action or proceeding arising out of or relating to the agreement shall be governed by the laws of the State of Arkansas. Vendor agrees that any act by the State regarding the agreement is not a waiver of either the State's sovereign immunity or the State's immunity under the Eleventh Amendment of the United States Constitution. As used in this paragraph, the term "agreement" means any transaction or agreement arising out of, relating to, or contemplated by this solicitation. As used in this Request for Proposals, the phrase "the State" includes any governmental entity in the State of Arkansas transacting business with the vendor pursuant to this agreement.

10.9 Severability

In the event any provision of this agreement is held to be invalid or unenforceable, the remaining provisions of this agreement will remain in full force.

10.10 Uniform Commercial Code

The applicable provisions of the Uniform Commercial Code as adopted by the State of Arkansas shall govern this contract.

10.11 Uniform Computer Information Transactions Act

The State of Arkansas has not adopted the Uniform Computer Information Transactions Act (UCITA), therefore, regardless of the adoption of UCITA by any states where the vendor may have operations, UCITA does not govern this contract.

10.12 Affirmative Action

Vendor shall comply with all federal and state requirements concerning fair employment and employment of the handicapped, and concerning the treatment of all employees, without regard to, or discrimination by reason of, race, color, religion, sex, national origin, or physical handicap.

10.13 Technology Access

When procuring a technology product or when soliciting the development of such a product, the State of Arkansas is required to comply with the provisions of Arkansas Code Annotated § 25-26-201 et seq., as amended by Act 308 of 2013, which expresses the policy of the State to provide individuals who are blind or visually impaired with access to information technology purchased in whole or in part with state funds. The Vendor expressly acknowledges and agrees that state funds may not be expended in connection with the purchase of information technology unless that system meets the statutory requirements found in 36 C.F.R. § 1194.21, as it existed on January 1, 2013 (software applications and operating systems) and 36 C.F.R. § 1194.22, as it existed on January 1, 2013 (web-based intranet and internet information and applications), in accordance with the State of Arkansas technology policy standards relating to accessibility by persons with visual impairments.

ACCORDINGLY, THE VENDOR EXPRESSLY REPRESENTS AND WARRANTS to the State of Arkansas through the procurement process by submission of a Voluntary Product Accessibility Template (VPAT) or similar documentation to demonstrate compliance with 36 C.F.R. § 1194.21, as it existed on January 1, 2013 (software applications and operating systems) and 36 C.F.R. § 1194.22, as it existed on January 1, 2013 (web-based intranet and internet information and applications) that the technology provided to the State for purchase is capable, either by virtue of features included within the technology, or because it is readily adaptable by use with other technology, of:

- Providing, to the extent required by Arkansas Code Annotated § 25-26-201 et seq., as amended by Act 308 of 2013, equivalent access for effective use by both visual and non-visual means;

- Presenting information, including prompts used for interactive communications, in formats intended for non-visual use;
- After being made accessible, integrating into networks for obtaining, retrieving, and disseminating information used by individuals who are not blind or visually impaired;
- Providing effective, interactive control and use of the technology, including without limitation the operating system, software applications, and format of the data presented is readily achievable by nonvisual means;
- Being compatible with information technology used by other individuals with whom the blind or visually impaired individuals interact;
- Integrating into networks used to share communications among employees, program participants, and the public; and
- Providing the capability of equivalent access by nonvisual means to telecommunications or other interconnected network services used by persons who are not blind or visually impaired.

If the information technology product or system being offered by the Vendor does not completely meet these standards, the Vendor must provide an explanation within the Voluntary Product Accessibility Template (VPAT) detailing the deviation from these standards.

State agencies cannot claim a product as a whole is not commercially available because no product in the marketplace meets all the standards. If products are commercially available that meet some but not all of the standards, the agency must procure the product that best meets the standards or provide written documentation supporting selection of a different product.

For purposes of this section, the phrase “equivalent access” means a substantially similar ability to communicate with, or make use of, the technology, either directly, by features incorporated within the technology, or by other reasonable means such as assistive devices or services which would constitute reasonable accommodations under the Americans with Disabilities Act or similar state and federal laws. Examples of methods by which equivalent access may be provided include, but are not limited to, keyboard alternatives to mouse commands or other means of navigating graphical displays, and customizable display appearance. As provided in Act 308 of 2013, if equivalent access is not reasonably available, then individuals who are blind or visually impaired shall be provided a reasonable accommodation as defined in 42 U.S.C. § 12111(9), as it existed on January 1, 2013.

As provided in Act 308 of 2013, if the information manipulated or presented by the product is inherently visual in nature, so that its meaning cannot be conveyed non-visually, these specifications do not prohibit the purchase or use of an information technology product that does not meet these standards.

10.14 Indemnification

The State of Arkansas, and any governmental entity transacting business with the vendor pursuant to this agreement, their officers, agents, and employees, shall be held harmless from liability from any claims, damages, and actions of any nature arising from the use of any materials furnished by the vendor, provided that such liability is not attributable to negligence on the part of the using agency or failure of the using agency to use the materials in the manner outlined by the vendor in descriptive literature or specifications submitted with the vendor’s proposal.

10.15 Liability for Damages

Vendor will not be liable to the State for any damages resulting from loss of data or use, or any incidental or consequential damages unless said damages are the result of the vendor’s negligence or willful misconduct.

The State will not be liable for any damages to the vendor resulting from loss of data or use, lost profits, or any incidental or consequential damages unless said damages are the result of the State's gross negligence or willful misconduct.

Vendor will be liable for damages resulting from personal injury or property damage caused by vendor's negligence or intentional harm.

10.16 Compliance with Laws

During the term of the contract, it shall be the vendor's responsibility to ensure compliance with all applicable provisions of laws, codes, ordinances, rules, regulations, and tariffs.

10.17 Insurance

Vendor shall maintain, throughout the performance of its obligations under this agreement, a policy or policies of Workers Compensation Insurance with such limits as may be required by law, and a policy or policies of general liability insurance insuring against liability for injury to, and death of, persons, and damage to, and destruction of, property arising out of, or based upon, any act or omission of the vendor any of its subcontractors or their respective officers, directors, employees or agents. Such general liability insurance shall have limits sufficient to cover any loss or potential loss resulting from this contract.

10.18 Licenses and Permits

During the term of the contract, the vendor shall be responsible for obtaining, and maintaining in good standing, all licenses (including professional licenses, if any), permits, inspections and related fees for each or any such licenses, permits or inspections required by the state, county, city or other government entity or unit to accomplish the work specified in this solicitation and the contract.

10.19 Risk of Loss

The vendor shall assume all risk of loss, and shall maintain insurance coverage on all items installed, up to the time of final acceptance.

10.20 Non-interference

In the event vendor is unable for any reason to provide any material, services, supplies, products or other items of any type or variety to the State under this agreement, including but not limited to any such materials, services, supplies, etc. available from any other party (such as subcontractors) supplying said materials, services, etc. to vendor, the State will have the right to deal directly with the other supplier without penalty or interference from vendor.

10.21 Subcontractors

Subcontractors will be permitted only with the prior written express consent of the AOC. Subcontractors are subject to the same terms and conditions of this agreement as the vendor.

10.22 Assignment

No contract or its provisions may be assigned, sublet, or transferred by the vendor without the prior expressed written consent of the AOC.

10.23 Item Substitution

No substitutes will be allowed on purchase orders received from the State without the prior expressed written consent of the AOC.

10.24 Contract Amendments, Modifications & Change Orders

Any change orders, alterations, amendments or other modifications to the contract subsequently negotiated between AOC and the vendor shall not be effective unless reduced to writing and approved by the AOC and the vendor.

10.25 Termination

10.25.1 Notice of Termination

In the event of any termination of the contract by the State, the AOC shall give notice of such termination in writing to the vendor. Notice of termination will be sent by certified mail, return receipt requested.

10.25.2 Termination for Non-Appropriations

Funds for this contract are payable from State and federal appropriations. In the event no funds or insufficient funds are appropriated and budgeted in any fiscal year for payments due under this contract, the AOC shall immediately notify vendor or its assignee, of such occurrence, and this contract may create no further obligation of the State as to such current or succeeding fiscal year, and may be null and void, except as to the portions of payments herein agreed upon for funds which shall have been appropriated and budgeted. In such event, this contract may be terminated, without penalty or expense to the State of any kind whatsoever, on the last day of the fiscal year for which appropriations were received. After such termination of this contract, the State shall have no continuing obligation to make purchases under this contract. No right of action or damages shall accrue to the benefit of the vendor or its assignee as to that portion of this contract, which may so terminate.

10.25.3 Remedies of Vendor in Event of Non-appropriation

Notwithstanding section 10.25.2 above, in the event of termination of this contract due to non-appropriation, the exclusive remedy of vendor and its assigns shall be to recover and possess any equipment and system, networking, and applications software for which vendor has not received complete payment. Vendor shall be allowed to enter the premises at such times as the State shall reasonably provide. Vendor may retain all payments on such equipment and system, networking, and applications software made by the State prior to said termination.

10.25.4 Insolvency

This contract is voidable and subject to immediate termination by the AOC upon the vendor's insolvency, including, but not limited to, the filing of proceedings in bankruptcy. The insolvency will result in the forfeiture of vendor's performance bond, if required, to the extent that it covers the costs incurred to the AOC from the time of contracting to the termination.

10.25.5 Termination for Convenience

This contract may be terminated for any reason by the AOC provided a sixty (60) day advance notice, in writing, is given to the vendor. In the event that this contract is terminated or canceled upon request and for the convenience of the AOC without sixty (60) days advance written notice, then the AOC shall negotiate reasonable termination costs, if applicable.

10.25.6 Termination for Cause

This contract may be canceled and terminated by the AOC at any time within the contract period whenever it is determined by the AOC that the vendor has made material misrepresentations in response to this RFP, or has materially breached or otherwise materially failed to comply with its obligations hereunder. The AOC will not be liable for any termination costs; the sixty (60) days advance notice requirement is waived.

10.25.7 Contract Violation

Vendors who violate this contract will be considered in breach and subject to cancellation for cause. Vendors may be suspended or debarred from doing business with the State of Arkansas. Examples of vendor violations include, but are not limited to:

- Vendor adding items to the contract without approval,
- Vendor increasing contract price without approval,
- Misrepresentation of the contract to any governmental entity.

10.25.8 Orderly Transfer of Materials

Upon termination of the contract for any reason, the AOC shall have the right, upon demand, to obtain access to, and possession of, all state properties, including, but not limited to,

current copies of all state application programs and necessary documentation, all files, intermediate materials and supplies held by the vendor.

10.25.9 Termination by Vendor

Requests for termination of this contract by the vendor must be received in writing by the AOC at least sixty (60) days before the requested contract termination date. Termination by vendor may result in vendor liability for termination costs.

10.26 Software Licenses

10.26.1 Software

Proprietary software is non-custom written, non-made for hire computer software supplied by the vendor and includes documentation used to describe, maintain and use the software. Customized software is made-for-hire, custom written and customer-specific software or customizations to proprietary software developed for the State by vendor and includes documentation used to describe, maintain and use the software. Third-party software is non-custom written, non-made for hire computer software supplied to the vendor by a third-party and includes documentation used to describe, maintain and use the software.

10.26.1.1 License

The contract resulting from this proposal will include a non-exclusive, perpetual license to use the proprietary and customized software acquired hereunder. The State's license to third-party software provided by the vendor shall be subject to the vendor's license to the third-party software; however, the State reserves the right to separately acquire any third-party software proposed by the vendor. Vendor is required to disclose to the State all terms of its license to third-party software that the vendor proposes to provide to the State.

10.26.1.2 Title

Title to any proprietary and customized software provided by the vendor to the State will remain with the vendor.

10.26.1.3 Trade Secrets

The State agrees that the proprietary and customized software is a trade secret of the vendor. The State agrees to take reasonable precautions to protect the trade secret nature of the proprietary software and to prevent its disclosure to unauthorized personnel. The license herein granted cannot be transferred, assigned, or made available by the State for use by any other individual, firm, partnership, or legal entity not affiliated, associated, or connected with the State without the prior expressed written consent of the vendor, which consent will not be unreasonably withheld. Such transfer shall also be conditioned upon the execution by the transferee of a written declaration agreeing to be bound by the terms and conditions of confidentiality provided for in this section.

10.26.1.4 Vendor Self-Help

Vendor agrees that during, or subsequent to the contract period, it will not use key codes, back doors, or any other technological means of disabling proprietary, customized, or third-party software provided to the State.

10.26.2 Source Code

Source code includes files used by assembly, basic, c, PL/SQL, database packages or other language compatibles to produce object modules for linkage into applications programs. The source code media will contain source code, files for compiling and linking software, and any other files and documentation available in machine-readable form to facilitate compiling and linking the code. Unless otherwise agreed to by both parties, source code does not include third-party software.

In the event the vendor, at any point during the continued installation and operation of the software herein acquired, discontinues the conduct of business, or for any other reason fails to continue to support the software, the AOC shall be provided a copy of the source code for said software within thirty days at no expense to the AOC.

For the effective term of this contract, vendor may either provide directly to the AOC or to a mutually agreed upon escrow agent the most recent version of the source code either on magnetic media or by any other method approved by the AOC.

The source code for proprietary and customized software shall be provided directly to the AOC or deposited into the escrow account within fifteen (15) days of the initiation of the contract, or any major update, enhancement, or release of said licensed software. Regardless of updates, the current version of source code shall be provided directly to the AOC or deposited in escrow on a regularly scheduled basis at a minimum of every 90 days. If deposited in escrow, the software escrow agent shall report to the designated AOC employee receipt of the source code.

Regardless whether the source code is provided directly to the AOC or deposited in escrow, unless otherwise agreed to by both parties, the source code may be accessed only upon the following conditions:

- Vendor refuses to provide software maintenance, bug fixes, upgrades, updates or enhancement services under the terms set forth in this contract or as generally provided similarly situated customers; or
- Vendor ceases to do business or exist as a valid business entity, as evidenced by an adjudication of bankruptcy or other definitive measure of cessation of operations
- With regards to proprietary and customized software, the State may not sell, assign, lease, or otherwise provide said source code(s) to any other person or entity, regardless of modification, without the express written consent of vendor, its successors, and assigns.

11 APPENDIX MATTER

11.1 Court Technology Improvement Act – Act 328 of 2009

<http://www.arkleg.state.ar.us/assembly/2009/R/Acts/Act328.PDF>

11.2 Administrative Order 19 – Access to Court Records

<https://courts.arkansas.gov/rules-and-administrative-orders/administrative-orders>

11.3 Information Technology Access for the Blind

Arkansas Code Annotated § 25-26-201 to -206

<http://www.lexis-nexis.com/hottopics/arcodes/>

Exhibit D

CSI Proposal in response to RFP, submitted March 27, 2014, attached as **Exhibit D**.



**State of Arkansas
Arkansas Supreme Court
Administrative Office of the Courts**

IMAGE AND ELECTRONIC DOCUMENT REDACTION

PROPOSAL

Presented by



791 Piedmont Wekiwa Road
Apopka, FL 32703
(407) 598-1801 Fax (407) 598-1879
Contact: Henry Sal Email: hsal@csisoft.com

NOTICE:

**This proposal contains Confidential Information.
Pages are clearly marked as CONFIDENTIAL in red footnote legends.**

Timothy N. Holthoff
Director of Court Information Systems Division
Administrative Office of the Courts
Justice Building
625 Marshall Street
Little Rock, AR 72201

Subject: Image and Electronic Document Redaction

Dear Mr. Holthoff:

It is with great pleasure that Computing System Innovations (CSI), an INC 5000 company, presents our solution to your redaction challenges. We appreciate the time that the Arkansas AOC staff has spent detailing your requirements.

Based on the experiences we have gained, our extensive national experience in courts, and our heritage in providing scanning, redaction and extraction solutions to organizations throughout the United States, we are confident that we can provide a solid and responsive level of software and services to your organization.

Our understanding is that the Arkansas Administrative Office of the Courts (AOC) is seeking a versatile document redaction solution that addresses the following needs:

- Redaction of confidential information as provided by Administrative Order 19 on pre-existing documents residing in AOC's Contexte case management system.
- Redaction of documents which are delivered to the AOC for storage in the Contexte repository as part of electronic filing.
- Redaction of documents which are local to individual courts, not integrated with the AOC's central system.
- Redaction of document in forward-file documents which are local to individual courts, as part of a scanning-to-storage workflow.

Offering best in class solutions, CSI's proposal response includes our flagship Intellidact Redaction technology with associated Validation and Management modules as a total solution for the Arkansas AOC.

We have also decided our best solution would also provide for statewide pricing, irrelevant of county size or volume, extending the best unit pricing to all counties irrespective of size. You will see such in our simplified state wide pricing model provided.

We look forward to working with you and exceeding your expectations on this important effort. If you have any questions, please feel free to call me directly at 407-598-1801.

Sincerely,

A handwritten signature in blue ink, appearing to read 'HSJ', is positioned above the typed name.

Henry Sal Jr., President
E-Mail: hsal@csisoft.com
Phone: (407) 598-1801

Table of Contents

1. Executive Overview	1-1
2. Vendor Company Information	2-1
Organizational Background and Professional Qualifications	2-1
Vendor Profile.....	2-1
CSI in Brief.....	2-1
Industry Partnerships	2-2
Qualifications.....	2-3
Product History	2-4
Installations.....	2-7
Primary References.....	2-7
Complete Customer List for Past Five Years	2-13
Letters of Recommendation	2-25
Staffing Plan.....	2-26
Customer Service Practices.....	2-30
Enhancements	2-31
Supplemental Information	2-31
Financial Information.....	2-32
Status of Firm.....	2-32
Financial Stability	2-32
Failure to Complete Prior Projects.....	2-32
Lawsuits	2-32
3. Project Plan and Methodology	3-1
Implementation Schedule/Work Plan	3-1
Project Plan Documentation	3-3
System Modification/Customization/Integration Plan.....	3-4
Initial Delivery Date	3-4
Training Plan & Schedule.....	3-5
Customer Service	3-5
Support.....	3-5
Problem Determination/Resolution Procedures.....	3-6
Risk Assessment Methodology.....	3-6
4. System Features, Upgrades, and Future Functionality.....	4-1
List and Description of System Features	4-1
Privacy Fields to be Redacted.....	4-1
Refining the Rule Set.....	4-2
Intellidact's OCR Engine.....	4-3
Image Integrity.....	4-4
Correction of Poor Images/Angular redactions	4-5
EyeSight.....	4-6
Manual Validation	4-7
Advanced Validation Features.....	4-7
Assisted Validation	4-10
Accuracy	4-10

Future Proofing™	4-11
Technology / Features Unique to Intellidact.....	4-14
Redaction Examples.....	4-21
Document Management System Integration.....	4-25
Configuration, Reports, Code, Rule, Control Tables.....	4-26
Configuration	4-26
Reporting.....	4-26
File Formats, Multi-media Support, and Security	4-29
List and Description of Services	4-29
Redaction Processing at CSI.....	4-29
Manual Redaction Validation at CSI	4-31
Review and Acceptance.....	4-32
Person Identification	4-34
System Architecture.....	4-35
Execution Environment	4-35
Performance, Scalability and Reliability	4-46
Data Access/Privacy/Integrity	4-52
System Security	4-54
Development Environment	4-55
Minimum Requirements	4-58
Design Flaws.....	4-68
Ability to Satisfy Requirements of Administrative Order 19	4-68
Assumptions.....	4-68
Other Information	4-68
5. Cost Proposal.....	5-1
Certification	5-1
Pricing.....	5-2
6. Appendix.....	6-1

1. Executive Overview

The vendor should include an executive overview of its organization, the benefits it brings to this project, its approach to this project, any partnering and subcontracting arrangements that it expects to use in fulfilling this contract, and any additional noteworthy information. In this section the vendor must provide a narrative of what is being proposed. The narrative should include the following items:

- The vendor should describe how the product(s) proposed best meet the State's needs and why the vendor recommends that the State select the product(s).
- The vendor should provide information on any competitive advantage the proposed product has over the competition.
- The vendor should provide a brief overview of the support and maintenance services it provides.

Our Approach

Based on the RFP, we understand that the Arkansas AOC is seeking a comprehensive solution that includes removal of privacy information whether it is well formed such as social security numbers or dynamic to a case such as a name. Our proposed solution is composed of a best in class software product.

- CSI's Intellidact® technology will perform the unstructured data recognition which will provide document classification and data redaction for privacy protection.
- The Intellidact component includes automatic document routing to specific subject matter experts, an intuitive manual validation interface, and high performance processing of documents in a single pass on our compute grid processing architecture.
- Redaction accuracy using Intellidact 3D™ technology is benchmarked to be 99.95% or greater for commonly known privacy fields such as SSNs, credit/debit card numbers, bank account numbers.
- Via our simplified statewide pricing, Intellidact will provide the best value to the taxpayers while protecting their identity information and Arkansas' investment in a comprehensive and extensible solution for years to come.

CSI, a proven technology firm having processed over 4.5 billion images to date nationally, has proven abilities to deliver high quality results on time and within budget. CSI's Intellidact product has the capability to rapidly address your document extraction and redaction needs now, and the flexibility to satisfy future redaction requirements without your organization incurring additional costs to reprocess.

Based on our understanding of the scope and requirements of your request, CSI's proposed action plan is attached, detailing our analysis, solutions architecture, staffing plans, references that support our abilities, estimated charges for the project, and options we believe you may wish to consider.

We are prepared with a complete staff and the technological means to serve the Arkansas AOC through and beyond day one of this project. Our project team encompasses strong project management and leadership, and the application of multi-disciplinary skills and expertise to address the complex technical and business needs of your requirements.

Why CSI?

We understand that you will be considering additional firms to perform these important services. We believe that working with CSI can provide several important benefits to the AOC:

1. We have assigned an experienced technical management team to this project, with strong leadership and extensive working knowledge of court document processing, your operational goals, and of course imaging and unstructured data recognition. The benefit to your office is that the work will be done efficiently, and the support will be based on hands-on practical national experience in court documents.
2. CSI's redaction and extraction expertise is wide-ranging and proven in large enterprise engagements. In our 20+-year history we have provided many solutions, and are engaged with several sophisticated global enterprises in addressing their unstructured data recognition challenges. Our efforts at your office will be based on real-world enterprise experience, supported by proven software technology, and management methodologies.
3. Our character recognition engines are currently utilized by the United States Post Office, the U.S. Census Bureau, the Internal Revenue Service, and the U.S. Social Security Administration. The billions of images processed by these organizations ensures you that you will have the most accurate and efficient technology available for use.
4. Our team is composed of industry recognized experts. As your organization progresses to new requirements in processing, CSI has local specialized technical resources to call on as needed.
5. We are the only INC 5000 company within the entire imaging, indexing, and redaction market space, for 2010, 2011, and 2012. Our INC 5000 recognition certifies that our staff, technology, and procedures are not only the best within our industry, but within the top one percent of all companies in America.
6. As necessary, CSI will augment the resources deployed to the project to assist in getting critical tasks completed on time during the term of the project.

Support and Maintenance Services

For daily processing support we utilize state of the art technology to assist our customers. CSI maintains hotline toll free support, a web support portal, WebEx remote support, and an “email to case” capability of obtaining support services. CSI utilizes Microsoft CRM with automated workflow to ensure proper support case escalations and management notifications to provide for strict SLA response compliance. CSI’s support staff is thoroughly trained and operates 7x24x365 with hours outside of 5x12 provided for by on call support staff. All business hours support, whether from EST to PST, is provided for by working staff.

CSI provides ongoing support via its automated support portal (support.csisoft.com), email, or toll free access (877-992-2900). CSI’s support system is fully automated to provide for automated assignments, SLA response time commitments, customer notifications, escalation to team lead, and management notifications required to provide best in class support for CSI products. CSI believes firmly in direct assignment of support cases to development team members to provide the quickest customer response and exchange of accurate information.

2. Vendor Company Information

Organizational Background and Professional Qualifications

If you are submitting a multi-vendor response, provide the below listed items for each vendor.

CSI is the original inventor of the technology we are proposing for your redaction solution. For enterprise wide solutions as for the State of Arkansas, CSI delivers, installs, configures, supports, and enhances our solution with no need for additional vendors. All answers provided below are in regards to CSI technology, processes, and procedures. Such allows us complete control of the entire software or services process providing us a 100% quality control advantage over any multi-vendor solution.

Vendor Profile

Provide a statement giving a brief history of your organization, how it is organized, and how its available resources will be utilized to meet the State's requirements.

CSI in Brief

- **Incorporated:** August 8, 1997 as Sal, Johnson & Associates, Inc., d/b/a Computing System Innovations (CSI). S Corporation in the State of Florida. Between 1987 and 1997, CSI was known as Computer Solutions of Orlando Inc.
- **Years in business:** 27. Consecutive three years INC magazine ranking, last year as #1,560 on the INC 5000 list of fastest growing companies in America.
- **Years involved with scanning/redaction/extraction services:** 11 years. CSI's commercial application division invented Intellidact[®], the first automated intelligent data redaction and extraction technology in 2003 and successfully brought it to market in 2004. Prior 16 years commercial software products for Judiciary and Court Clerks.
- **Federal Tax ID:** 59-3512778
- **Organization:** 85 staff members in three different locations, the primary location being corporate headquarters in Apopka, Florida. Breakdown by job function: Executive Management: 4; Sales/Marketing: 3; Development: 15; Support: 6; Implementation: 5; Redaction/Indexing Services: 52.
- **Arkansas Project Resource Utilization:** CSI deploys Intellidact for either on site customer processing or offsite processing at CSI's secure data center. Depending on the deployment model elected by the AOC and Counties, specific CSI resources will be assigned to the Arkansas project as dedicated project team resources. The personnel and areas of responsibility are provided for in our project team diagram located on page 2-26.

For offsite processing resources CSI maintains our own state of the art data center. This is available for customers that wish to offload software processing, and if desired, any associated manual validation. The "offload" of data to CSI's data center can be either with un-attended scheduled batch transmission or real time transfers. Our RFP response includes

both as an option for the counties selection in handling their historical document scanning projects.

For offsite validation we maintain a staff of fifty two subject matter privacy experts that for the past 10 years have processed hundreds of millions of images. We are our own customer here and utilize the same software we deliver for onsite customer use. This provides you with a strategic advantage that product enhancements (to increase accuracy, speed, and ease of use) come from within where we are concerned about saving fractions of a second and improving accuracy by 1/10th of a percent. The benefit to you is the most accurate, fastest, and easiest to use redaction software on the market.

For those customers that desire an on premise installation CSI will provide dedicated resources for installation, configuration, and training services. Due to our size we can dedicate experts to perform such **concurrently in multiple counties** based upon each counties desired implementation date.

Within our references we have provided multi-year tens of millions of images per year customers where CSI performs offsite processing and validation, as well as multi-year customers that have redacted using onsite processing and their own validation.

For any custom integration efforts we have in-house development staff that consists of skilled architects, developers, testers and quality control staff that would be dedicated resources to any efforts required here. Note that with Intellidact provision and support of **generic web services, ECF4.0 (e-filing), or NIEM (Xerox Contexte's)** we don't expect custom integration development to be required on this project. Should however such be required to deal with any legacy system that doesn't support modern interface technology, CSI has development staff ready to assist to ensure complete project success.

Industry Partnerships

CSI is a strategic partner of **Hewlett Packard**, having been selected as their **exclusive worldwide redaction solution**. As such CSI works closely with HP and is on the forefront of identity theft protection requirements on a global basis, adding unsurpassed knowledge to all our US based customer projects.

CSI is a strategic partner of **Iron Mountain**, and provides Intellidact technology and processing services on behalf of Iron Mountain to both Fortune 100 and Federal Government customers for both automated indexing and data redaction of privacy information. CSI's Central Florida processing facility is one of a **select few Iron Mountain approved secure processing facilities** and is audited routinely by Iron Mountain to maintain such certification. The benefit to AOC is that in any offsite processing you are assured our processing of your images will be performed to the **highest level of security standards**.

CSI is a strategic technology partner of the **Open Text Group** and has **exclusive rights** to utilize their leading character recognition engines as a component in Intellidact processing.

CSI maintains corporate memberships with **PRIA, NACRC, IEEE and AIIM**. CSI has been a guest speaker on redaction technologies at AIIM, NACRC, and PRIA. Currently CSI is a contributing author on PRIA's Redaction Best Practices white paper, having been requested to

provide the section on accuracy computation as a standard for the land records industry.

CSI is a partner with Harris Computers/Aptitude (Case / Land records Management software vendor), Tyler Technology (Case / Land records Management software vendor), Thomson Reuters/Mantron (Land records software vendor), CourtView Systems – (Case / Land records Management software vendor), Pioneer Technology Group, CDS (Case Management software vendor), ImageTek (Capture and document management systems), and Doculynx, providing automated data redaction and extraction technology within their core business software and service product lines.

Qualifications

Briefly provide information that highlights your organization's particular abilities to successfully complete the State's requirements and how you would structure, develop, and manage the project.

Intellidact's data redaction / extraction technology has been the core line of business for CSI's software development teams for the past 11 years. We design, develop, produce, support, (eat sleep and breathe) redaction/extraction/classification technology, and employ some of the leading image processing and unstructured data recognition experts in the world. Our particular ability to successfully exceed the State's requirements is based upon several items.

First our unique enterprise court experience – not only are we multi-jurisdictional but we are the only company responding to your RFP with multiple statewide AOC RFP awards and experience (AOC Commonwealth of Virginia, AOC Rhode Island, AOC Iowa, ILRS Iowa, and Washington State). In addition we recently were awarded the Texas Urban Counties redaction RFP (37 of their largest counties).

As such, CSI's organization is familiar with what is required of complex state installations, training, processing, and the freedom of choice by counties. For proven experience on statewide redaction projects we are at the top of the list.

Next, we have the highest accuracy rates in the industry - verified in head to head benchmarks conducted by our customers – 17 times more accurate than a competitor on complex court data (enclosed Pinellas reference) – 5 times more accurate than another on simple social security numbers (San Diego scoring sheet).

We have the fastest image processing, most accurate readaction, and highly extensible architecture - our compute grid provides automatic page level load balancing and out of the box high availability for processing. Intellidact has processed the largest amount of documents in the US to date –currently that's 4.5 billion pages – with 500+ installations.

Having our feet firmly anchored in the Court software world, we provide advanced redaction features to assist with court document redaction such as TotalCase™, Privacy Data Minimization, Fact Extraction, Obfuscation, Redaction Security Profiles, etc...

We have selected a leading team of CSI experts having world renowned expertise in image processing, identity theft and its protections as you will see in review of our proposed project team (see page 2-8) and their resumes.

Far more important than us and our telling you about ourselves is you. We believe every customer no matter how large or how small needs to get whatever attention is needed to make their project a success. Our particular ability to successfully complete the State of Arkansas redaction project is that we are a company that has been designed from the ground up to execute flawlessly on your enterprise redaction project and we have many success stories on our doing so for you to reference.

Product History

Describe the history of your solution, including: initial release date, current version number, development history (e.g., was it developed as a marketable package, or as a solution for a particular organization), and the environments to which it has been ported. Please provide a list of case management systems and document management systems with which the system has been successfully integrated.

CSI's commercial application division has a proven track record of providing software solutions to solve real world business problems for public sector customers for more than 27 years, and is national in scope. CSI's commercial application division invented **Intellidact**[®], the first automated intelligent data redaction/extraction technology, in 2003, and successfully brought it to market in 2004. Since then, Intellidact has **processed more than 4.5 billion images** in the United States and has received industry recognition for its technology, winning **two first place awards at AIIM** in the innovative solutions and document compliance categories. Intellidact has been widely reviewed within industry publications, and CSI staff is industry noted for their expertise in unstructured data / image processing. CSI's accomplished staff members have been invited guest speakers at major industry conferences and government symposiums, and have been requested as authors from within the property record industry. The most recent being PRIA's request for **CSI experts to author the accuracy section of PRIA's Redaction Best Practices** white paper.

The design of Intellidact was **started in 2003** by CSI's application division, with CSI customers requesting better solutions to their existing document indexing processes. Intellidact provides a core ability to locate unstructured data on document images with **unsurpassed accuracy**, and then redact / extract the specified data without the problems associated with humans manually performing such processes. Using sophisticated data-recognition algorithms, combined with **four character recognition engines exclusive to CSI**, Intellidact properly classifies documents and rapidly locates specified data to be redacted and/or extracted, whether in **handprint, machine print, MICR, barcode, or cursive script** formats, within an **extensible computational grid architecture**. Intellidact's grid architecture proven on billions of images for some of the largest automated redaction projects in history is easily scalable, highly available, fault tolerant, and automatically load balanced. Such allows Intellidact to **exceed your expectations** in ease of use, processing speed, and resultant accuracy.

CSI corporate experience for enterprise scale redaction and indexing **government** customers include **Recorders, Judicial Circuits, Supreme Courts, Clerks of Courts, and Comptrollers** throughout the largest counties in Arizona, California, Colorado, Florida, Kentucky, Massachusetts, Minnesota, Missouri, New Mexico, New York, North Carolina, Pennsylvania, Tennessee, Texas, Washington (District of Columbia), and Wisconsin. In addition to local

county experience, Intellidact processes the entire **States of Alaska, Iowa, Rhode Island, Virginia and Washington (state)**. While vendors may tout county level experience, CSI is the only redaction vendor that can provide the benefits of both local county experiences within a state blended with national expertise from **state wide processing** projects. In land records alone **Intellidact provides privacy protection for one out of every five Americans**.

The image volume processed by these counties and states with Intellidact is the same order of magnitude of the AOC requirements, and as such has provided CSI with unsurpassed hands-on **enterprise volume** and **multiple jurisdiction experience** required to successfully process and **Future Proof™** your documents at **99.95% accuracy**. The software and services being provided in these redaction/extraction projects utilize CSI's Intellidact software technology for unstructured data recognition location, then automatic redaction and indexing.

CSI full time subject matter experts have also participated in Intellidact backfile validation work from our Central Florida corporate headquarters to minimize customer upsizing of staff to accommodate large backfile repositories. The result in providing Intellidact software with CSI services results in providing the **highest verifiable levels of accuracy** in redaction processing and the **built in means** for customer scoring and acceptance.

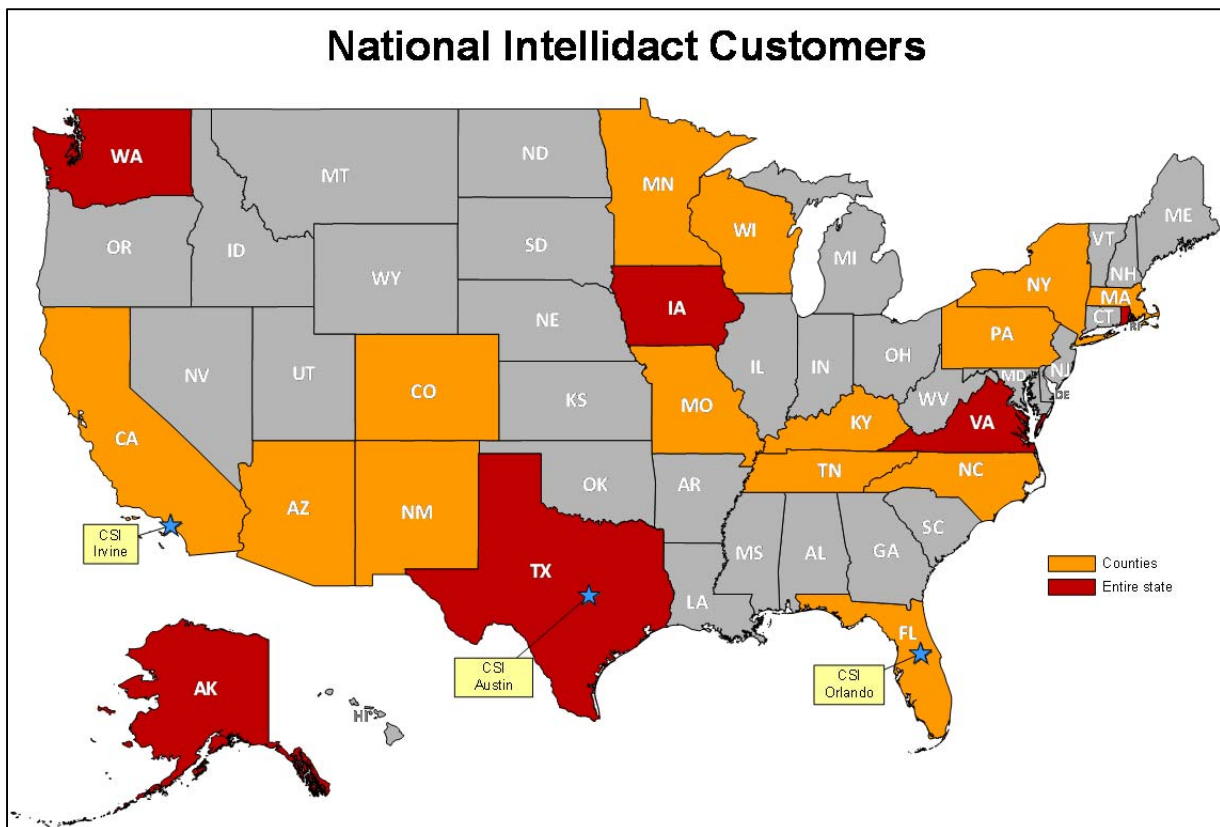

CSI is the only redaction solution provider that can claim having processed the **first successful automated redaction project** in the United States (Marion County Florida 2005 – 7 million images within 7 weeks at **99.7% accuracy** verified by the customer reviewing each image), the **largest automated redaction project** in the United States to date (Miami-Dade County Florida – 85M documents), and the **fastest sustained processing project** (Palm Beach County Florida – 110M back file images at 500,000 images-per-day, while processing a 45 million images-per-year forward file workload, all on customer equipment). CSI's redaction technology is

production proven to redact Social Security Numbers, Organization IDs, EINs, TINs, VINs, DLs, State IDs, Email addresses, DOBs, Passport, Checking, Savings, Credit, Debit, Bank, Investment account numbers, maiden names, minor children names and ages, biometric finger/palm prints, and with technology only available from CSI, **cursive signatures**.

Intellidact includes an intelligent validation tool, IntelliValidate, which allows operators to **rapidly and accurately validate** the results of processing. IntelliValidate tracks each change made to an image within the relational Intellidact database, which maintains a **complete forensic audit trail** of all image modification, and serves as the source for providing image history and process accuracy reporting. Intellidact also provides the ability to **“Future Proof™” costly redaction efforts** by locating all privacy and identity information that exist on an image in a single pass, and storing such within Intellidact’s database for future use. IntelliValidate also integrates seamlessly within an **Ephesoft** workflow, can function as a standalone application, or can have its redaction validation functions easily embedded within other modern applications by use of the Intellidact Software Development Kit (SDK).

As legislative requirements expand over time to include additional sensitive information, CSI’s subject matter expertise and storage of these field locations have such **available for reuse without additional processing**. Intellidact was designed to process existing images as part of a back file conversion project, or be easily integrated with existing document capture systems, providing document compliance for both old and new documents. In either instance, Intellidact **consistently provides** the most **cost-effective, high-volume, high accuracy** redaction solution with the least amount of manual verification required within the growing redaction industry.

CSI distinguishes Intellidact from other solution vendors that may have core competence either in software creation or the manual validation service offerings by being the only redaction vendor that is **both the inventor** of its patent pending redaction software/algorithms **and the provider** of in-house validation services. **CSI employs no subcontractors** in any image processing or manual validation steps, but rather utilizes fulltime subject matter experts, who undergo a rigorous training/testing program before they are permitted to validate CSI customer documents. This provides **CSI with 100% quality control** for all project steps under one roof. This approach allows CSI to deliver redaction work products that exceed customer expectations and **eliminate unnecessary customer risk**.

In addition to improvements in redaction technology accuracy via ongoing investments in research and development, CSI continues to **listen and respond** directly to its customer’s business requirements and produce innovative technology enhancements. Since our customers are national and disperse we provide for a virtual user group that allows for submission of ideas and community voting to determine which features are implemented and become part of the base product as opposed to those that may be acquired as individual customer enhancements.

CSI firmly believes in a **no surprises approach** to image processing deliverables. For the entire life of a project, CSI provides customers easy-to-use access to their specific processing environment. Customers can perform randomized spot checks of processing at any point by using Intellidact’s built-in accuracy scoring, and eliminate last minute surprises after months of processing at CSI to ensure that contracted levels of accuracy are being met at all times during processing. It is rare when a project does not contain unexpected surprises. However, CSI has the **leading industry experts on staff** to call upon to ensure the customer receives a no surprise project, and results that exceed customer expectations.

Installations

Provide a complete list of your customers for the past five years who have used or are using the product or similar services to those proposed in your response to this RFP, including contact names, addresses, and phone numbers. Indicate whether these are single or multi-jurisdictional installations. Also include the components and product version number each customer currently uses and the corresponding implementation date. Provide date and reason for contract termination, if applicable.

Primary References

Customer Name	Palm Beach County Clerk of Courts
Project Name	Intellidact Indexing and Redaction and TrakScan
Timeframe	Project is ongoing.
Project Description	Back file / forward file redaction with data extraction, document classification and scanning. Real time interfaces with Xerox/Banner and Courtview/Showcase CMS, New Vision Land records, and Florida state e-filing portal.
“Go Live” Date	January 2006
Project Scope	Both Land records and Court document redaction and indexing processing. 110,000,000 images processed.
Volumes / Users	Total Pages per month: 25,000,000/month during backfile processing; Currently 40,000,000/year forward file Concurrent Users: 600+
Technical Environment	Windows Server Environment with 120+ Grid CPUs
Types of Interfaces and Integration Tools Used	Intellidact Universal Web Services, Intellidact Workflow Services, DMS (TrakMan) Web Services, Kofax integration modules, Showcase Enterprise Services Buss (web services), State E-file portal web services (ECF 4.0 standard), Email to Case, Tyler Eagle e-recording web services, external e-recording web services (PRIA 2.4 standard), eIssuance, Issuance filedrop.
Project Outcome	Production Processing
Contact Information	Name: Sharon Bock Title: Clerk & Comptroller Phone: (561) 355-2996 Email: sbock@mypalmbeachclerk.com — or — Name: Karen Heidtman, Esq Title: Director of Project Management Phone: (561) 355-1924 Email: kheidtma@mypalmbeachclerk.com <hr/> 205 North Dixie Highway, Room 3.2402 West Palm Beach, FL 33402

**THIS PAGE CONTAINS CONFIDENTIAL INFORMATION
(Highlighted in Red)**

Customer Name	Pinellas County Clerk of Courts
Project Name	Intellidact Redaction and Indexing for Courts, Land Records, and Citations
Timeframe	Project is ongoing.
Project Description	<p>Back and forward file redaction of land records and court documents. In addition to redaction, data classification and extraction is also performed.</p> <p>Real Time interfaces to Tyler Technologies Odyssey CMS, Harris Computer Systems OnCore Land Records, CASE360 DMS and Florida state E-filing portal.</p> <p>What makes Clerk Burke's organization noteworthy and applicable to AOC's evaluation of redaction vendors is even after the Clerk's office had already purchased another redaction vendors technology his staff discovered that CSI's provide higher accuracy (on a scale of 16x better) and they switched. A reference letter from Clerk Burke has been enclosed for your review.</p>
"Go Live" Date	January 2011
Project Scope	<p>Courts: Backfile/Forward File redaction/indexing integrated to Tyler's Odyssey CMS</p> <p>Land records: Forward file redaction, interface to Aptitude Encore. Replacement of purchased Mentis technology to improve redaction accuracy. Approximately 7,400,000 images processed.</p>
Volumes / Users	<p>Total Pages per month: 750,000</p> <p>Concurrent Users: 100+</p>
Technical Environment	Windows Server Environment with 30+ Virtual Grid Servers
Types of Interfaces and Integration Tools Used	Intellidact Universal Web Services, Intellidact IWS, Tyler Odyssey CIP API, and Kofax integration modules used.
Project Outcome	Phase 1 and 2 complete.
Contact Information	<p>Name: Ken Burke Title: Clerk of the Circuit Court Phone: (727) 464-3341 Email: kburke@pinellascounty.org or kburke@co.pinellas.fl.us</p> <hr/> <p>315 Court Street, 4th floor Clearwater FL 33756</p>

**THIS PAGE CONTAINS CONFIDENTIAL INFORMATION
(Highlighted in Red)**

Customer Name	Miami-Dade Clerk of the Courts
Project Name	Intellidact Redaction
Timeframe	Project is ongoing.
Project Description	Backfile and Forward file redaction. Real Time interfaces to Tyler Odyssey CMS
“Go Live” Date	January 2007
Project Scope	Backfile Redaction Services approx. 65,000,000 land record images Forward File in implementation
Volumes / Users	Total Pages per year (forward file): 30,000,000 court images Concurrent Users: 700+
Technical Environment	Windows Server Environment
Types of Interfaces and Integration Tools Used	Intellidact Configurable Integration Publisher Interface, Intellidact Universal Web Services, Intellidact Workflow Services
Project Outcome	Production Processing
Contact Information	Name: Thomas G. James Title: CIO Phone: (305) 349-6192 Email: Tom.james@miamidade.gov <hr/> 175 NW 1st Ave, Ste 2625 Miami, FL 33128

**THIS PAGE CONTAINS CONFIDENTIAL INFORMATION
(Highlighted in Red)**

Customer Name	Broward County Clerk of the Courts
Project Name	Intellidact Indexing & Redaction eRecording with Odyssey
Timeframe	Project is ongoing. Real Time interfaces to Tyler Odyssey CMS, and Aptitude Land records, and Florida State E-file portal
Project Description	Forward file redaction, Document classification, extraction, scanning
“Go Live” Date	April 2009
Project Scope	Forward Filing Redaction from court documents, integrated with e-filings, producing searchable PDF files
Volumes / Users	Total Pages per year: 30,000,000 Concurrent Users: 350
Technical Environment	Windows Server Environment with 168 Grid CPUs
Types of Interfaces and Integration Tools Used	Intellidact Universal Web Services, Intellidact Workflow Services, Kofax integration modules, State E-file portal web services (ECF 4.0 standard), Tyler Odyssey CMS integration, e-recording web services, external e-recording web services (PRIA 2.4 standard) with OnCore integration, eIssuance.
Project Outcome	Production Processing
Contact Information	Name: Ernesto Nardo Title: Director of Technology Phone: (954)831-7079 Email: enardo@browardclerk.org <hr/> 201 SE 6th Street, Room 768 Ft. Lauderdale, FL 33301

**THIS PAGE CONTAINS CONFIDENTIAL INFORMATION
(Highlighted in Red)**

Customer Name	San Diego County Recorder/Clerk
Project Name	Intellidact Redaction
Timeframe	Project is ongoing.
Project Description	Backfile and Forward file redaction
“Go Live” Date	January 2011
Project Scope	Forward File Redaction Services: Daily transfer/processing/validation/return of documents at CSI. Backfile Redaction Services: 70,000,000 images
Volumes / Users	Total Pages per month (forward file): 190,000 Concurrent Users: 12
Technical Environment	Windows Server Environment
Types of Interfaces and Integration Tools Used	Intellidact Workflow Services
Project Outcome	Production Processing
Contact Information	Name: Val Wood Title: Chief Deputy Recorder/County Clerk Phone: (619)557-4035 Email: Val.Wood@sdcounty.ca.gov <hr/> 1600 Pacific Hwy, Rm 260 San Diego, CA 92101

**THIS PAGE CONTAINS CONFIDENTIAL INFORMATION
(Highlighted in Red)**

Customer Name	Marion County Clerk of Courts
Project Name	Intellidact Redaction and Indexing for Courts, Land Records
Timeframe	Complete
Project Description	This Clerk's office was the first successful automated redaction project to prevent identity theft in the United States. Although the processing volume is small by today's standards 9 years ago 7 million images being processed in 7 weeks with 99.7% accuracy won CSI and the Clerk's office two 1 st place AIIM awards for innovative application of technology in the document compliance category.
"Go Live" Date	October 2004
Project Scope	First successful automated redaction project in the United States. 7,000,000 images processed in 7 weeks with customer validated 99.7% accuracy occurring 8 years ago.
Volumes / Users	Total Pages per month: 350,000 pages Concurrent Users: 250
Technical Environment	Windows Server Environment
Types of Interfaces and Integration Tools Used	Intellidact Universal Web Services, Intellidact IWS, and Kofax integration modules used.
Project Outcome	Complete in production
Contact Information	Name: David Ellspermann Title: Clerk of the Circuit Court Phone: (352) 671-5603 Email: ellspermann@marioncountyclerk.org <hr/> 110 NW 1st Avenue Ocala, FL 34475

**THIS PAGE CONTAINS CONFIDENTIAL INFORMATION
(Highlighted in Red)**

Complete Customer List for Past Five Years

Customer are listed in institution alphabetical order and are currently using Intellidact version 4.2

Public Institution:	Adams County Wisconsin (via third party)
Address:	1851 Miede Drive Grimes, IA 50111
Contact Person:	Quentin Williamson, Sales Executive
Telephone Number:	(515) 270-4858 x224
Service Provided:	Back file Redaction
Date of Implementation	March 2011 to March 2012

Public Institution:	Alexandria Virginia Clerk of Circuit Court
Address:	520 King Street Alexandria, VA 22314
Contact Person:	John Knippenberg
Telephone Number:	(703) 838-4060 ext 183
Service Provided:	Backfile/Forward File Redaction of approx. 250,000 images per year Daily transfer / processing / validation / return of documents at CSI
Date of Implementation	February 2009 to Present

Public Institution:	Arizona Secretary of State
Address:	Finance Office 1700 West Washington Street, 7th FL Phoenix, AZ 85007
Contact Person:	Susan Myers
Telephone Number:	(602) 542-6171
Service Provided:	Redaction Services approximately 1.9M images
Date of Implementation	December 2007

Public Institution:	Arlington County Virginia
Address:	2100 Clarendon Blvd., Suite 612 Arlington, VA 22201
Contact Person:	Paul Carter
Telephone Number:	(703) 228-3203
Service Provided:	Backfile Redaction Services of approx. 7,000,000 images Daily transfer / processing / validation / return of documents at CSI
Date of Implementation	December 2008 to Present

**THIS PAGE CONTAINS CONFIDENTIAL INFORMATION
(Highlighted in Red)**

Public Institution:	Bay County Clerk of Courts
Address:	300 East 4 th Street Panama City FL 32401
Contact Person:	Bill Kinsaul, Clerk of the Courts
Telephone Number:	(850) 763-9061
Service Provided:	Forward Filing Redaction for OR & Courts
Date of Implementation	September 2012 to Present

Public Institution:	Bernalillo County Metropolitan Court
Address:	401 Lomas Blvd, Room 803 Albuquerque, NM 87102
Contact Person:	Bill Hopkinson, IT Director
Telephone Number:	(505) 841-9881
Service Provided:	Forward Filing Redaction/Extraction
Date of Implementation	June 2008 to Present

Public Institution:	Broward County Clerk of Courts
Address:	201 SE 6 th Street, Room 768 Ft. Lauderdale, FL 33301
Contact Person:	Ernie Nardo, Director of Technology
Telephone Number:	(954) 831-7079
Service Provided:	Forward Filing Redaction from court documents, integrated with e-filings, producing searchable PDF files. 30Million images per year.
Date of Implementation	April 2009 to Present

Public Institution:	Burnett County Wisconsin (via third party)
Address:	1851 Mieke Drive Grimes, IA 50111
Contact Person:	Quentin Williamson, Sales Executive
Telephone Number:	(515) 270-4858 x224
Service Provided:	Back file Redaction
Date of Implementation	March 2011 to April 2012

Public Institution:	Centre County Recorder of Deeds
Address:	414 Holmes St., Suite 1 Bellefonte, PA 16823
Contact Person:	Joseph Davidson
Telephone Number:	(814) 355-6801
Service Provided:	Back File Redaction of 2,883,729 images for SSN & Tax ID
Date of Implementation	April 2010

**THIS PAGE CONTAINS CONFIDENTIAL INFORMATION
(Highlighted in Red)**

Public Institution:	Centre County Prothonotary
Address:	102 Centre County Courthouse High & N Allegheny Sts Bellefonte, PA 16823
Contact Person:	Debra C. Immel, Prothonotary & Clerk of Courts
Telephone Number:	(814) 355-6796
Service Provided:	Back File Redaction of 3,416,114 images & validation of SSN's.
Date of Implementation	February 2011

Public Institution:	Central Susquehanna Intermediate Unit
Address:	90 Lawton Lane Milton, PA 17847
Contact Person:	Joe Banks
Telephone Number:	(570) 523-1155
Service Provided:	Forward File Redaction 30K Images.
Date of Implementation	October 2009 to Present

Public Institution:	Citrus County Clerk of Courts
Address:	110 N Apopka Avenue Inverness, FL 34450
Contact Person:	Keith Heisner
Telephone Number:	(352) 341-6497
Service Provided:	Electronic Document Management with Workflow and Redaction
Date of Implementation	March 2007 to Present

Public Institution:	Dallas County Iowa (via third party)
Address:	1851 Miede Drive Grimes, IA 50111
Contact Person:	Quentin Williamson, Sales Executive
Telephone Number:	(515) 270-4858 x224
Service Provided:	Back file Redaction
Date of Implementation	April 2012

Public Institution:	Davidson County Circuit Court Clerk
Address:	1 Public Square, Ste. 302, Nashville, TN 32701
Contact Person:	Randall Ladd
Telephone Number:	(615) 862-5966
Service Provided:	Backfile/Forward Redaction Services SSN, Bank and Credit Cards for approximately 2.7M images with validation
Date of Implementation	July 2008 to Present

**THIS PAGE CONTAINS CONFIDENTIAL INFORMATION
(Highlighted in Red)**

Public Institution:	FINRA
Address:	9509 Key West Avenue Rockville, MD 20850
Contact Person:	James Ridgway, Project Mgr – RAD Technology
Telephone Number:	(240) 386-4845
Service Provided:	Intellidact Enterprise
Date of Implementation	October 2010 to Present

Public Institution:	Flagler County Clerk of Courts
Address:	1769 E Moody Blvd., Bldg. 1 Bunnell, FL 32110
Contact Person:	Gail Wadsworth
Telephone Number:	(386) 437-7410
Service Provided:	Forward Filing Redaction/Indexing
Date of Implementation	August 2006 to Present

Public Institution:	Highlands County Clerk of Courts
Address:	590 S. Commerce Ave Sebring, FL 33870
Contact Person:	Jerome Kaszubowski, Sr. Director of Business Services
Telephone Number:	(863) 402-6830
Service Provided:	Forward File Redaction and Indexing
Date of Implementation	March 2012 to Present

Public Institution:	Indian River County Clerk of Courts
Address:	2000 16 th Avenue Vero Beach, FL 32960
Contact Person:	Jeffrey R. Smith, Clerk of Courts
Telephone Number:	(772) 226-3160
Service Provided:	Courts Back File Redaction, 5.07 Million Images
Date of Implementation	April 2012 to January 2014

Public Institution:	Iowa Land Records
Address:	Iowa County Recorders Association 5408 NW 88th Street, Suite 120 Johnston, IA 50131
Contact Person:	Phil Dunshee
Telephone Number:	(515) 491-8939
Service Provided:	Forward and Back Filing Redaction Services, OR Daily transfer / processing / validation / return of documents at CSI
Date of Implementation	August 2009 to Present

**THIS PAGE CONTAINS CONFIDENTIAL INFORMATION
(Highlighted in Red)**

Public Institution:	Jackson County Wisconsin (via third party)
Address:	1851 Miehe Drive Grimes, IA 50111
Contact Person:	Quentin Williamson, Sales Executive
Telephone Number:	(515) 270-4858 x224
Service Provided:	Back file Redaction
Date of Implementation	March 2011

Public Institution:	Jefferson County Clerk of Courts
Address:	531 Court Place Room 201C Louisville, KY 40202
Contact Person:	David G. Summerfield, Director Information Technology
Telephone Number:	(502) 574-8600
Service Provided:	Forward File Redaction, Back File Redaction with Validation
Date of Implementation	December 2010 to Present

Public Institution:	Lake County Clerk of Courts
Address:	550 W Main Street Tavares, FL 32778
Contact Person:	Brent Holladay, Chief Deputy, Information Resources
Telephone Number:	(352) 742-4109
Service Provided:	Back Filing Redaction/Forward Services remove SSN, Bank, Credit Card, Debit Cards from approximately 1,413,000 images
Date of Implementation	September 2005 to Present

Public Institution:	Leon County Clerk of Courts
Address:	301 S. Monroe Street, Room 100 Tallahassee, FL 32301
Contact Person:	Gypsy Bailey, General Counsel/Director of Courts
Telephone Number:	(850) 577-4011
Service Provided:	Forward File Redaction 1.8 Million Images per year
Date of Implementation	March 2012 to Present

Public Institution:	Levy County Clerk of Courts
Address:	355 S. Court St. Bronson, FL 32621
Contact Person:	Deanna Dobbins, Director of Court Services
Telephone Number:	(352) 486-5266 x255
Service Provided:	Forward File Redaction 450K Images per Year
Date of Implementation	September 2011 to Present

**THIS PAGE CONTAINS CONFIDENTIAL INFORMATION
(Highlighted in Red)**

Public Institution:	Marion County Clerk of Courts
Address:	110 NW 1st Avenue Ocala, FL 34475
Contact Person:	David Ellspermann, Clerk of the Circuit Court
Telephone Number:	(352) 671-5603
Service Provided:	Backfile/Forward Redaction Services SSN, Bank and Credit Cards for approximately 7.0M images
Implementation Date	October 2004 to Present

Public Institution:	Martin County Clerk of Courts
Address:	100 E. Ocean Blvd Stuart, FL 34995
Contact Person:	Cheri Vancura, Chief Deputy Operations
Telephone Number:	(772) 288-5736
Service Provided:	Backfile/Forward File Redaction Services approx. 4,000,000 images
Implementation Date	August 2009 to Present

Public Institution:	Miami-Dade Clerk of the Courts
Address:	Courthouse Center 175 Northwest First Avenue, Suite 2720 Miami, FL 33128
Contact Person:	Thomas G. James, CIO
Telephone Number:	(305) 349-6192
Service Provided:	Backfile Redaction Services approx. 65,000,000 images land records. 30M forward file court records/year.
Date of Implementation	January 2007 to Present

Public Institution:	Monroe County Clerk of Courts
Address:	500 Whitehead Street Key West, FL 33040
Contact Person:	Tangela Thurston, IT Manager
Telephone Number:	(305)292-3419
Service Provided:	Back file Redaction for 2.7Million TIFF images, SSN's Bank Accounts, Debit Account and Credit Card Numbers
Implementation Date	August 2012 to September 2012

Public Institution:	Missouri Office of the Secretary of State
Address:	Information Technology Services Division 600 W. Main St., Room 367 Jefferson City, MO 65101
Contact Person:	Brick M. Morff, Director
Telephone Number:	(573) 526-2125
Service Provided:	Redaction Services Land Records
Implementation Date	November 2007 to February 2008

**THIS PAGE CONTAINS CONFIDENTIAL INFORMATION
(Highlighted in Red)**

Public Institution:	North Carolina Secretary of State
Address:	2 South Salisbury Street Raleigh, NC 27601
Contact Person:	Cheri Myers, Director of Corporations
Telephone Number:	(919) 807-2050
Service Provided:	Backfile Redaction Services 6,500,000 images
Implementation Date	April 30, 2008

Public Institution:	Okaloosa County Clerk of Courts
Address:	101 E. James Lee Blvd. Crestview, FL 32536
Contact Person:	Robbie Brown, Director of Information Technology
Telephone Number:	(850) 689-5000 x3305
Service Provided:	Forward File Redaction 1.8 Million Images per year – Back File Courts 6.6 Million Images per year
Date of Implementation	October 2012 to Present

Public Institution:	Osceola County Clerk of Courts
Address:	2 Courthouse Square, Suite 2000 Kissimmee, FL 34741
Contact Person:	Derek Pietruszewski, Director of Information Technology
Telephone Number:	(407) 742-3702
Service Provided:	Forward File Courts/Backfile OR Redaction and Validation Services
Implementation Date	December 21, 2007 to Present

Public Institution:	Outagamie County Register of Deeds
Address:	410 S. Walnut Street Appleton, WI 54911
Contact Person:	Sarah Van Camp, Register of Deeds
Telephone Number:	(920) 832-5095
Service Provided:	Redaction Backfile
Implementation Date	November 2011 to May 2013

Public Institution:	Palm Beach County Clerk of Courts
Address:	205 North Dixie Highway, Room 3.2402 West Palm Beach, FL 33402
Contact Person:	Sharon Bock, Clerk & Comptroller Karen Heidtman, Esq., Director of Project Management
Telephone Number:	(561) 355-2996 (Bock); (561) 355-1924 (Heidtman)
Service Provided:	Backfile/Forward File Redaction with Workflow and Image Storage. Forward file 40 million images/yr. backfile contract 110 million images, searchable PDF files
Implementation Date	January 2006 to Present

**THIS PAGE CONTAINS CONFIDENTIAL INFORMATION
(Highlighted in Red)**

Public Institution:	Pasco County Clerk of Courts
Address:	7530 Little Road, Suite 106 New Port Richey, FL 34654
Contact Person:	Paula O'Neil, Clerk of the Courts
Telephone Number:	(727) 464-4321
Service Provided:	Forward File Redaction 6.5 Million Images per Year
Implementation Date	September 2012 to Present

Public Institution:	Pinellas County Clerk of Courts
Address:	315 Court Street, Room 400 Clearwater, FL 33756
Contact Person:	Ken Burke, Clerk of the Circuit Court
Telephone Number:	(727) 464-3341
Service Provided:	Forward-file redaction and indexing with e-filing, producing searchable PDF files. 9million court images/year
Implementation Date	January 2011 - present

Public Institution:	Polk County Clerk of Courts
Address:	255 N. Broadway Bartow, FL 33831
Contact Person:	Stacy Butterfield, Clerk of Courts
Telephone Number:	(863) 534-4540
Service Provided:	Backfile Redaction OR
Date of Implementation	May 2006 to September 2008

Public Institution:	Polk County Wisconsin (via third party)
Address:	1851 Miede Drive Grimes, IA 50111
Contact Person:	Quentin Williamson, Sales Executive
Telephone Number:	(515) 270-4858 x224
Service Provided:	Back file Redaction
Date of Implementation	May 2011 to September 2011

Public Institution:	Price County Register of Deeds
Address:	126 Cherry St. Phillips, WI 54555
Contact Person:	Judith L. Chizek, Register of Deeds
Telephone Number:	(715) 339-2515
Service Provided:	Backfile Redaction SSN's, bank, credit and debit accounts
Date of Implementation	February 2014 to Present

**THIS PAGE CONTAINS CONFIDENTIAL INFORMATION
(Highlighted in Red)**

Public Institution:	Rusk County Wisconsin (via third party)
Address:	1851 Miehle Drive Grimes, IA 50111
Contact Person:	Quentin Williamson, Sales Executive
Telephone Number:	(515) 270-4858 x224
Service Provided:	Back file Redaction
Date of Implementation	July 2011

Public Institution:	Sacramento County Clerk/Recorder
Address:	600 8th Street Sacramento, CA 95814
Contact Person:	Louise Martinez, Chief Deputy Clerk/Recorder
Telephone Number:	(916) 874-7851
Service Provided:	Backfile Redaction Services OR
Implementation Date	October 2008 to Present

Public Institution:	San Diego County Recorder/Clerk
Address:	1600 Pacific Hwy, Rm 260 San Diego, CA 92101
Contact Person:	Val Wood, Chief Deputy Recorder/County Clerk
Telephone Number:	(619) 557-4035
Service Provided:	Forward File Redaction Services Daily transfer / processing / validation / return of documents at CSI 70 million images.
Implementation Date	October 2008 to Present

Public Institution:	San Diego Hazardous Materials (via third party)
Address:	15378 Avenue of Science San Diego, CA 92128
Contact Person:	Doculynx: Jerry Smith
Telephone Number:	(858) 716-3542
Service Provided:	Backfile Redaction Services remove DL and DOB approx. 611,644 images
Implementation Date	June 2011 to November 2011

Public Institution:	Sarasota County Clerk of Courts
Address:	2000 Main Street Sarasota, FL 34237
Contact Person:	Janet Cantees, Chief Deputy
Telephone Number:	(941) 861-7603
Service Provided:	Forward File Redaction 38 Million Images per year & Back File Redaction 2.5 Million Images per year.
Date of Implementation	June 2013 to Present

**THIS PAGE CONTAINS CONFIDENTIAL INFORMATION
(Highlighted in Red)**

Public Institution:	St. Johns County Clerk of Courts
Address:	4010 Lewis Speedway St. Augustine, FL 32084
Contact Person:	Mark Dearing, Director of Computer Services
Telephone Number:	(904) 819-3611
Service Provided:	Forward File Redaction 1.5 Million Images per year
Date of Implementation	October 2011 to Present

Public Institution:	St. Lucie County Clerk of Courts
Address:	201 South Indian River Drive Ft. Pierce, FL 34950
Contact Person:	Joseph E. Smith, Clerk of Courts
Telephone Number:	(772) 462-2345
Service Provided:	Redaction up to 2.9 Million Images per year, image cleanup processing OCR/ICR/Voting and Future Proof
Date of Implementation	May 2012 to Present

Public Institution:	Seminole County Clerk of Courts
Address:	3001 N. Park Avenue Sanford, FL 32771
Contact Person:	Shahid L. Khoja, Director of Information Technology
Telephone Number:	(407) 665-4418
Service Provided:	Intellidact is being used to redact information from court documents, and to process and validate e-filings in real time from the FCCC portal, and to produce searchable PDF files.
Implementation Date	September 2009 to Present

Public Institution:	Shelby County Tennessee
Address:	201 Poplar Avenue, RMLL-81 Memphis, TN 38103
Contact Person:	Stephen Wingo, CIMS
Telephone Number:	(901) 222-2647
Service Provided:	Forward File Redaction
Implementation Date	June 2012 to Present

Public Institution:	Sonoma County Clerk/Recorder
Address:	585 Fiscal Drive, Rom 104F Santa Rosa, CA 95403
Contact Person:	Janice Atkinson, Clerk-Recorder-Assesor
Telephone Number:	(707) 565-5470
Service Provided:	Backfile Official Records
Implementation Date	June 2009 to March 2011

**THIS PAGE CONTAINS CONFIDENTIAL INFORMATION
(Highlighted in Red)**

Public Institution:	Supreme Court of Virginia Department of Judicial Information
Address:	100 North 9th Street Richmond, VA 23219
Contact Person:	Robert Smith, Director
Telephone Number:	(804) 786-8631 or (804) 786-6455
Service Provided:	Backfile Redaction Services approx. 55,000,000 images
Implementation Date	February 2008 to Present

Public Institution:	Travis County Clerk of Courts (via third party)
Address:	1807 West Braker Lane, Suite 400 Austin, TX 78758
Contact Person:	Manatron: Ira McMillian
Telephone Number:	(866) 917-4354
Service Provided:	Redaction Image Processing approximately. 10,355,562
Implementation Date	December 2006 to February 2008

Public Institution:	Vernon County Register of Deeds
Address:	400 Courthouse Square, Rm 110 Viroqua, WI 54665
Contact Person:	Konna Spaeth, Register of Deeds
Telephone Number:	(608) 637-5371
Service Provided:	Back File Redaction
Date of Implementation	October 2010 to January 2014

Public Institution:	Vilas County Wisconsin (via third party)
Address:	1851 Miede Drive Grimes, IA 50111
Contact Person:	Quentin Williamson, Sales Executive
Telephone Number:	(515) 270-4858 x224
Service Provided:	Back file Redaction
Date of Implementation	January 2013 to June 2013

Public Institution:	Wakulla County Clerk of Courts
Address:	3056 Crawfordville Highway Crawfordville, FL 32327
Contact Person:	Brent Thurmond, Clerk of Courts
Telephone Number:	(850) 926-0905
Service Provided:	Forward File Redaction Civil, Criminal, Probate, Traffic and OR Records
Date of Implementation	June 2011 to Present

**THIS PAGE CONTAINS CONFIDENTIAL INFORMATION
(Highlighted in Red)**

Public Institution:	Washara County Wisconsin (via third party)
Address:	1851 Miede Drive Grimes, IA 50111
Contact Person:	Quentin Williamson, Sales Executive
Telephone Number:	(515) 270-4858 x224
Service Provided:	Back file Redaction
Date of Implementation	September 2011

**THIS PAGE CONTAINS CONFIDENTIAL INFORMATION
(Highlighted in Red)**

Letters of Recommendation

Included on pages following:

- Palm Beach County Clerk of Courts
- Pinellas County Clerk of Courts
- Supreme Court of Virginia
- Marion County Clerk of Courts



SHARON R. BOCK

Clerk & Comptroller
Palm Beach County

Timothy N. Holthoff
Director of Court Information Systems Division
Administrative Office of the Courts
Justice Building
625 Marshall Street
Little Rock, AR 72201

Dear Mr. Holthoff:

It is my distinct pleasure to recommend to you Computing System Innovations. In my capacity of Chief Operating Officer of the Palm Beach County Clerk and Comptroller's office I have worked closely with their staff for the past ten years on projects critical for our organization's success. During these ten years CSI has provided superior software and services, but more importantly has become a trusted technology partner for our offices.

As it is my understanding that you are embarking on an enterprise redaction project, we are uniquely qualified to comment on their software and services. We have used CSI's Intellidact technology to redact forty million existing land record documents with efficiencies and high accuracy allowing us to complete our project a full year in advance of our statutory requirements. They are contracted to redact an additional 100 million court documents as well. Needless to say we are very pleased with our selection of CSI and the results.

CSI technology is also used in our organization to automate the processing of approximately 45 million pages of land records and court documents received at our offices yearly. We have been able to not only redact information at very high levels of accuracy, but to automatically classify documents and extract their pertinent data which in turn has reduced our manual data entry.

Going beyond technology and into what makes one company a better choice over another, CSI team has consistently demonstrated a partnership approach to technology and potential work solutions. I would highly recommend CSI to provide redaction software and conversion services to your organization. They are accessible, responsive and flexible with a clear focus on customer service and satisfaction. Please feel free to contact me for any further information.

Sincerely,

A handwritten signature in black ink, appearing to read "Un Cha Kim", with a long horizontal flourish extending to the right.

Un Cha Kim
Chief Operating Officer
Courts & Official Records

301 North Olive Avenue
West Palm Beach, Florida 33401

P.O. Box 229
West Palm Beach, Florida 33402

Telephone 561-355-2996
Facsimile 561-355-6727

www.pbcountyclerk.com

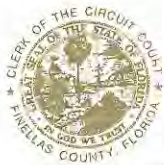

KEN BURKE

CLERK OF THE CIRCUIT COURT — PINELLAS COUNTY, FLORIDA

Clerk of the County Court
Recorder of Deeds
Clerk and Accountant of the Board of County Commissioners
Custodian of County Funds
County Auditor
Clerk of the Water and Navigation Control Authority

315 Court Street
Clearwater, FL 33756-5165
Telephone: (727) 464-3341
Fax: (727) 464-4162
kburke@pinellascounty.org
www.pinellasclerk.org

Timothy N. Holthoff
Director of Court Information Systems Division
Administrative Office of the Courts
Justice Building
625 Marshall Street
Little Rock, AR 72201

Dear Mr. Holthoff:

CSI has asked if I would be willing to provide a reference for their redaction technology, and I do not hesitate in doing so. A good vendor can help make our jobs easier, and that is what CSI has done for us. They have a "can do" attitude, not hesitating to address any questions or concerns that we may have.

As your office does, the Pinellas County Clerk's office is also using Aptitude as our official records software. Aptitude incorporates Mentis for its redaction processing within their official records system. In attempting to utilize Mentis redaction technology for our court documents, we found the accuracy results were not acceptable. In an attempt to confirm vendor accuracy, we performed additional testing on the court documents to mirror our processing environment and simple demonstrations.

In our evaluation, both Mentis and CSI were provided with 1.4 million probate court images. After six processing runs using Mentis technology, the error rate was 8.4%. CSI's first pass processing produced a 1.75% error rate, and with adjustments to their technology, the second pass produced an error rate of 1/2 of 1 percent. As these were our most challenging documents, CSI's accuracy rate being 16 times greater than Mentis after one pass was impressive enough for us to purchase their technology.

While we are utilizing Aptitude for our official records software, we are also implementing Tyler's Odyssey case management system. CSI has been contracted by my office to provide intelligidact redaction, auto docketing, and FCCC e-file portal interface for all our case management systems.

The CSI staff members are experts in their field, with a superior redaction product that processes court documents reliably, accurately, and rapidly. We have been satisfied with our decision to utilize the product offered by CSI, and are confident in recommending them to you.

Sincerely,

Ken Burke

KB/kl

EXECUTIVE SECRETARY
KARL R. HADE

ASSISTANT EXECUTIVE SECRETARY &
LEGAL COUNSEL
EDWARD M. MACON

COURT IMPROVEMENT PROGRAM
LELIA BAUM HOPPER, DIRECTOR

EDUCATIONAL SERVICES
CAROLINE E. KIRKPATRICK, DIRECTOR

FISCAL SERVICES
JOHN B. RICKMAN, DIRECTOR

HISTORICAL COMMISSION
MELINDA LEWIS, DIRECTOR

SUPREME COURT OF VIRGINIA



OFFICE OF THE EXECUTIVE SECRETARY
100 NORTH NINTH STREET
RICHMOND, VIRGINIA 23219-2334
(804) 786-6455

HUMAN RESOURCES
VACANT

JUDICIAL INFORMATION TECHNOLOGY
ROBERT L. SMITH, DIRECTOR

JUDICIAL PLANNING
CYRIL W. MILLER, JR., DIRECTOR

JUDICIAL SERVICES
PAUL F. DELOSH, DIRECTOR

LEGAL RESEARCH
STEVEN L. DALLE MURA, DIRECTOR

LEGISLATIVE & PUBLIC RELATIONS
KATYAN. HERNDON, DIRECTOR

Timothy N. Holthoff
Director of Court Information Systems Division
Administrative Office of the Courts
Justice Building
625 Marshall Street
Little Rock, AR 72201

Dear Mr. Holthoff:

I commend to you on behalf of the Office of the Executive Secretary - Supreme Court of Virginia, Computing System Innovations (CSI) as leaders in the field of redaction software and services. As the Director of Judicial Information Technology, I am responsible for a land records system used in 75 Virginia courts. We also serve as the central public repository for local county image search and retrieval for these 75 courts.

In the fall of 2007, we issued an RFP to provide redaction software and services for our existing 49 million land records as well as integration within our existing systems to process 8 million newly filed documents per year. The vendor response was of national scope, and after our thorough vetting process, CSI's Intellidact technology was elected as being superior in redaction accuracy and although not the least expensive, the best value to the citizens of Virginia. During the vetting process, CSI's staff impressed our selection committee as the most knowledgeable vendor for the task by providing unique solutions within their response to satisfy challenges we had yet to discover would exist. We are very happy with our selection and the results of their processing.

In addition to using CSI redaction software and services, we have been impressed with their knowledge to request CSI experts be keynote speakers at our upcoming yearly clerk's conference. The topic of this presentation is to be identity theft, fraud and available protections. I am also aware the office of Virginia's Attorney General utilizing CSI staff knowledge as an expert witness in redaction technologies at a federal trial on Internet public record identity theft being heard in our state. I highly recommend CSI as having the software technology and expert staff to provide you with a superior redaction solution. Should you require any additional information, please contact me as required.

Very truly yours,

A handwritten signature in black ink, appearing to read "Robert L. Smith".

Robert L. Smith, Director
Department of Judicial Information Technology
Office of the Executive Secretary
Supreme Court of Virginia



Clerk of the Circuit Court

Marion County

Post Office Box 1030 • Ocala, Florida 34478-1030

David R. Ellspermann

Clerk of the Circuit Court

Telephone (352) 671-5604

Facsimile (352) 671-5600

Timothy N. Holthoff
Director of Court Information Systems Division
Administrative Office of the Courts
Justice Building
625 Marshall Street
Little Rock, AR 72201

Dear Mr. Holthoff:

I have been asked to write a letter of recommendation to assist in the success of Computing System Innovations, Mr. Henry Sal. I am honored to be asked to do this letter because CSI has been a great part of our success (see attached recognition documents). CSI produced a solution to deliver a digital product to our stakeholders (citizens, businesses and governments) while providing identification protection through their superior redaction software. CSI products are superior as its efficiency and effectiveness directly creates the equal efficiency and effectiveness in our business operations.

Agency heads, or persons making a product selection, often consider after the contract signature whether delivery of product and customer services will meet expectations. CSI has the ability to meet expectations and when challenged they create a solution that will benefit both customer and the software.

Since 2005 CSI has maintained a positive professional partnership that has created success for all stakeholders.

You may contact me at ellspermann@marioncountyclerk.org or use the above phone number.

Sincerely,

David R. Ellspermann
Clerk of the Circuit Court

DRE/ppm
enclosures

Staffing Plan

Provide your company's staffing plan for the next three years.

CSI future staffing plans are to provide additions to project management, business analysts, Q/A testers, and development team members, exact numbers are not known and are based upon company growth. We have added between 3 and 7 staff members per year for the past three years. We expect this to be an average of additions per year for the next 3 years. As for the staff plan resulting from any RFP award to CSI for Arkansas they are as follows.

Ms. Un Cha Kim will provide executive project management for any AOC project award and is the COO of CSI. Ms. Kim has an extensive background in the operation of large urban county court operations having served at the Palm Beach and Miami-Dade Clerk and Comptrollers offices in senior management positions. Ms. Kim reports directly to and advises both the president and vice president of CSI, Mr. Henry Sal and Mr. Glen Johnson.

All of the CSI project team members are recognized experts in the management of enterprise government projects and/or state of the art document processing technology. They will be dedicated to ensuring the smooth implementation, processing, and ongoing management and support for a successful redaction/extraction project.

Un Cha Kim, Esq.

- Chief Operating Officer, CSI
- Oversees all aspects of CSI's operation
- Veteran of Organizational Leadership and Management
- Successfully led and managed large scale government operations with over 780 employees and \$35+ million operating budget
- Prior employment: **Chief Operating Officer, Clerk & Comptroller, Palm Beach County, Florida**, responsible for operation of Courts and Legal Records for 3rd largest county in Florida. Successfully implemented a number of complex, multi-million dollar software systems that affect entire county population and beyond
- Strong proponent of utilizing technology to optimize business efficiency and effectiveness
- Expert in fusing effects of political, financial and human elements into business and government operations
- Possesses extensive knowledge of legal and legislative processes
- Education: BBA, Austin Peay State University/Florida International University; Juris Doctor, University of Miami, School of Law
Member of Florida Bar
- Executive team member responsible for overall project success

Dean Hough

- Director of Research, CSI
- Prior employment: **Co-founder and Chief Technology Officer of KOFAX¹** (14 years), design engineer (2 years), FileNet (3 years), imaging consultant (3 years)
- Industry Expert in scanners, document image management, image processing, forms processing, character recognition, handprint recognition
- Managed development of KOFAX Adrenaline hardware, Kofax Image Controls, Kofax Ascent Capture and Kofax Virtual Rescan image processing
- Education: BSEE, San Diego State
- Responsible for software based signature detection processing, and visual image fingerprint technology to accommodate low quality non OCR capable images

Victor Lee

- National Account Manager, CSI
- Build and maintain relationships with channels partners and customers
- Facilitate contract negotiations and terms improvements
- Manage all SLG, Legal, and Healthcare sales domestically
- Prior employment: Director of Operations of Creative Data Solutions (10 years)
- Managed and developed team responsible for Court Case Management, Land Records, and Prosecutor systems.
- Education: BA; University of Central Florida
- Responsible for procurement efforts

Frank W. Abagnale

- Special project consultant to CSI
- Employment: Founder of Abagnale and Associates, Inc.
- Related Experience – Mr. Abagnale is a world renowned expert at identity theft
- Responsible for identification of all Future Proof™ processing fields

Trey Pickett

- Technical Project Manager, CSI
- Expert in paper and microfilm transformation to digital images / image cleanup processing, business process analysis and automated workflow
- Related Experience - certified Project Manager; 65M land record back file project management responsibilities, responsible for all CSI daily service processing (Iowa, Virginia, etc...) (500M plus images)
- Ephesoft Certified
- Certified in Kofax Ascent Capture with Advanced Forms specialization
- Employment: 6 years at CSI; 12 years at other firms
- Education: BS, University of Florida
- Responsible for all on and offsite project management (liaison), onsite accuracy validation training, and final product acceptance

¹ Mr. Dean Hough and Mr. David Silver, both Kofax co-founders, are responsible for the invention of PC based scanning and as such are recognized visionaries in the image processing industry.

Glen Johnson

- Co-Founder and Vice President, CSI
- PMP Certified Project Manager
- Project Architect CSI Intellidact
- Expert in rule set development specializing in image classification, data location and redaction processing
- Project manager of first automated redaction solution in United States
- Designed HPUX business productivity and performance tools, currently in use on 20,000+ worldwide sites
- Certified in Kofax Ascent Capture with Advanced Forms specialization
- Employment: 27 years at CSI; 10 years with Texas Instruments Data Systems Group software architect for TI's machine learning efforts on the Explorer System
- Education: BS, University of Minnesota
- Responsible for extraction/redaction quality and rule set refinements

Michael Stanley

- Quality Control supervisor, CSI
- Responsible for training and certification of CSI redaction team members
- Related Experience – Analyzed and supervised over the quality control of 20 separate projects for 80 different counties while at CSI
- Developed a step-by-step job responsibility manual and conducted training sessions for new employees
- Enforce quality control standards of redaction projects
- Employment: 5 years at CSI; 2 years Redaction Center Supervisor Manatron/Hart InterCivic
- Education: BA, Texas A&M University

Project Management Institute

THIS IS TO CERTIFY THAT

Glen Johnson

HAS BEEN FORMALLY EVALUATED FOR DEMONSTRATED EXPERIENCE,
KNOWLEDGE AND SKILLS TO LEAD AND DIRECT PROJECT TEAMS AND IS HEREBY
BESTOWED THE GLOBAL CREDENTIAL

Project Management Professional

IN TESTIMONY WHEREOF, WE HAVE SUBSCRIBED OUR SIGNATURES UNDER THE SEAL OF THE INSTITUTE.

Beth Partleton

Beth Partleton · Chair, Board of Directors

Mark A. Langley

Mark A. Langley · President and Chief Executive Officer



PMP® Number **1392157**

PMP® Original Grant Date **26 February 2011**

PMP® Expiration Date **25 February 2014**



Arkansas Administrative Office of the Courts CSI Project Team

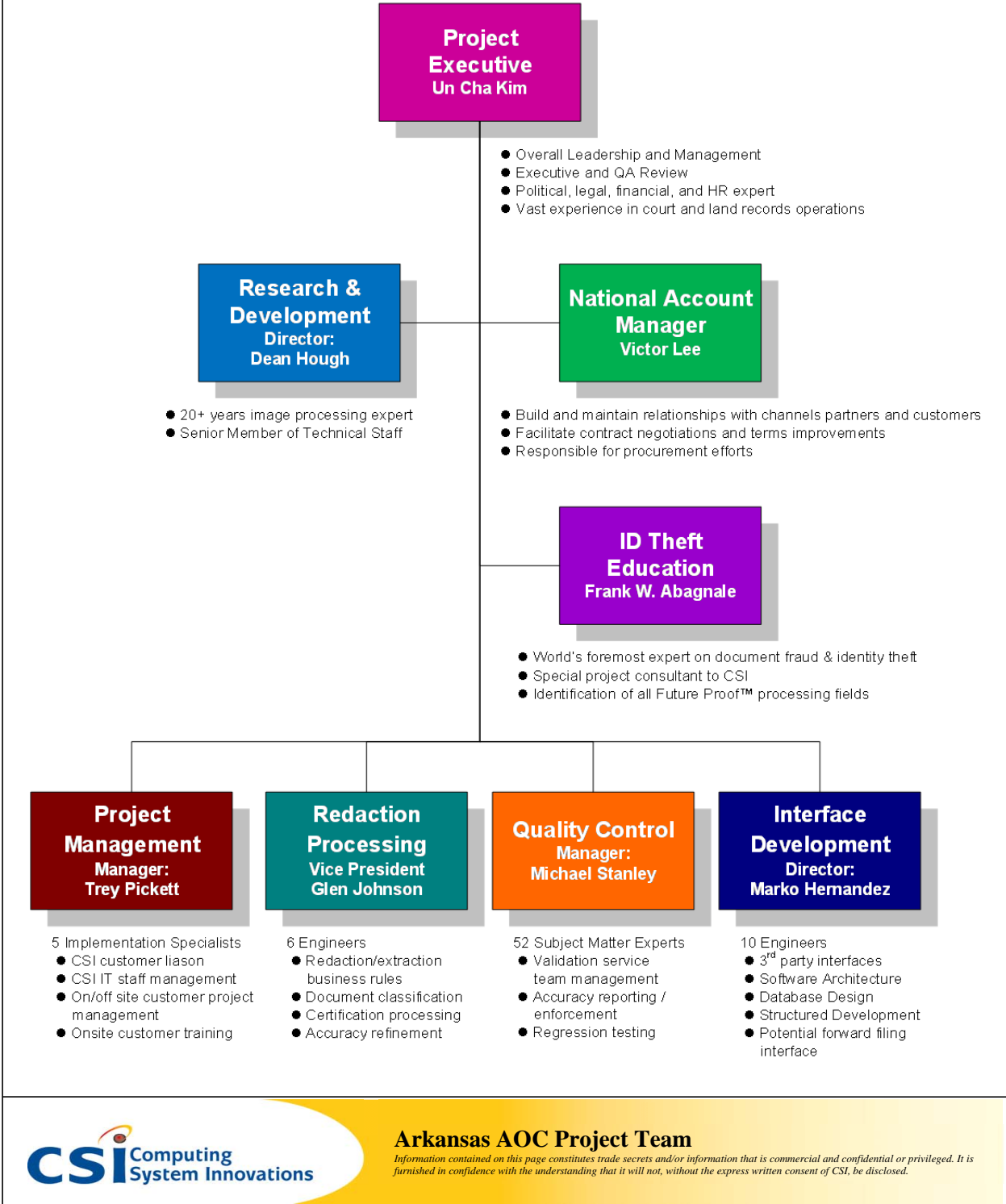

Arkansas AOC Project Team

Information contained on this page constitutes trade secrets and/or information that is commercial and confidential or privileged. It is furnished in confidence with the understanding that it will not, without the express written consent of CSI, be disclosed.

Customer Service Practices

Provide a statement explaining your customer service practices, including hours of operation, call prioritization system, response times for each level of priority call, number of staff assigned, and location of support. Also include historical information or estimates of the number and duration of customer service calls you receive on a periodic basis (daily, weekly, or monthly).

For daily processing support we utilize state of the art technology to assist our customers. CSI maintains hotline toll free support, a web support portal, web based remote support, and an “email to case” capability of obtaining support services. CSI utilizes Microsoft CRM with automated workflow to ensure proper support case escalations and management notifications to provide for strict SLA response compliance. CSI’s support staff is thoroughly trained and operates 7x24x365 with hours outside of 5x12 provided for by on call support staff. All business hours support, whether from EST to PST, is provided for by working staff at CSI corporate headquarters in Florida.

CSI provides ongoing support via its automated support portal (support.csisoft.com), email, or toll free access (877-992-2900). CSI’s support system is fully automated to provide for automated assignments, SLA response time commitments, customer notifications, escalation to team lead, and management notifications.

In CRM, customer-initiated support tickets are prioritized as Normal / Low / High based on a triage assessment of severity and the nature of the ticket (Problem / Question / Request). Of course, High Priority cases are addressed immediately, while others are queued as staff is available. There are 6 CSI staff members dedicated to support issues, with an average monthly volume of 100 CRM tickets.

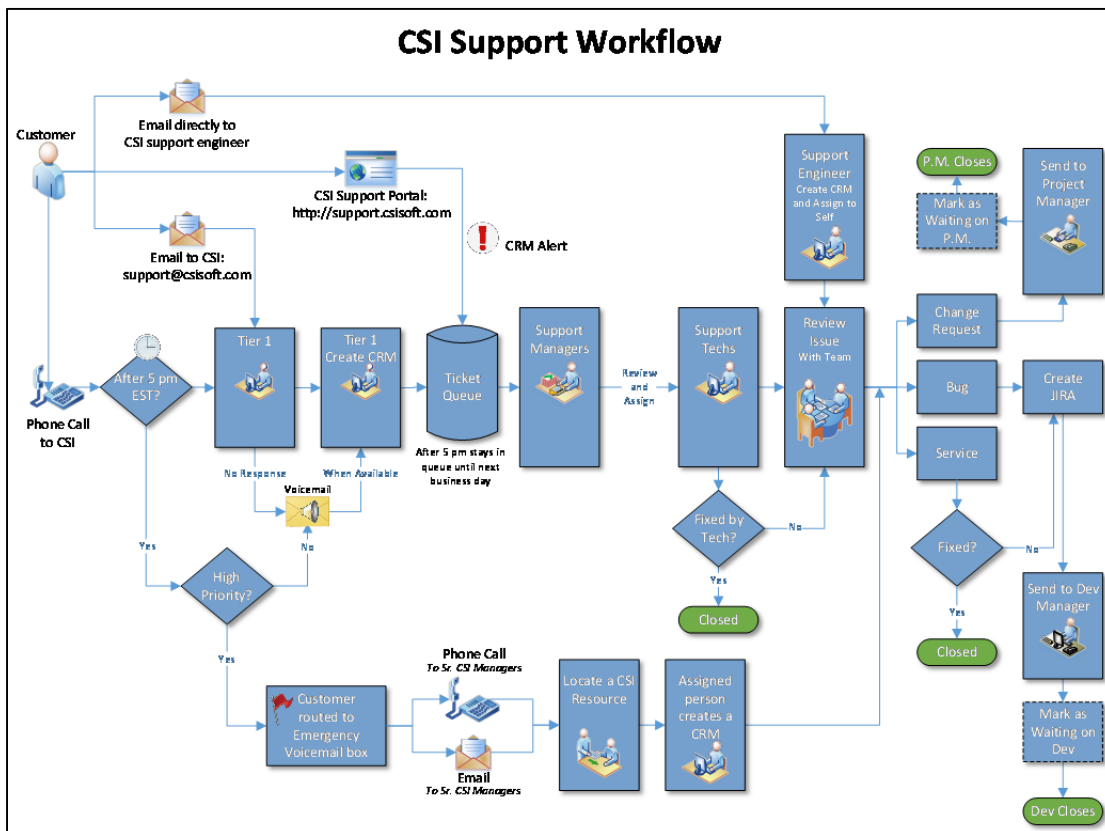

Enhancements

Describe the process by which system enhancement opportunities are identified, screened, programmed, tested and released to users.

CSI believes that success is based upon our ability to provide customers a mechanism to voice their desires and for CSI to produce innovative technology that leaves them delighted. As we support a national customer base, we employ a virtual user group forum that allows for submission of ideas by our customers or our own staff. The forum is open to all CSI customer and they have equal rights to submit and electronically vote on product suggestions. We use customer voting to gauge community interest for particular features and to determine if the enhancement suggestion will be accomplished within the base product for all customers, offered as an optional new product, or offered to the customer under a change request specific for that customer. Suggestions that make it past the suggestion stage fall under CSI's standard development, test, and release methodology (Scrum agile sprints).

Supplemental Information

Provide any supplemental information that you think will be valuable to the State in evaluating your qualifications and personnel regarding your ability to meet the State's requirements.

We believe we have identified all the information valuable to the State within other areas requested in the proposal.

Financial Information

Status of Firm

If a corporation, list the state and date of incorporation. If other than a corporation, list all general partners, joint ventures and persons or entities with an interest of ten percent (10%) or more in the company, indicating the title, if any, and the percentage of the interest of each.

CSI was incorporated on August 8, 1997 as Sal, Johnson & Associates, Inc., d/b/a Computing System Innovations (CSI). S Corporation in the State of Florida. Between 1987 and 1997, CSI was known as Computer Solutions of Orlando Inc. Total years in business: 27.

Financial Stability

Provide proof of your financial stability (e.g., corporate financial statement for the last 5 years).

CPA compilations are provided for the last five years at the end of this section. CSI's FY 2013 statement has not been finalized as of this time (early May 2014). Please note all CSI financial information is Company confidential and is marked as such.

CSI is privately held company. From its inception CSI has been self-funded from projects and software sales and is debt averse. CSI was selected by INC Magazine as one of the 5,000 fastest growing companies for 2010, 2011 and 2012.

CSI's Dun and Bradstreet DUNS number is 061353525, and rating is "1R2".

Failure to Complete Prior Projects

Disclose whether your organization (or any general partner or joint venture thereof) has ever failed to complete an electronic filing project. If so, list the date of commencement of the project and the entity for which the project was to be performed, and explain why the project was not completed.

CSI has never failed to complete a project –document redaction, electronic filing, or otherwise.

Lawsuits

Disclose any lawsuits that have been brought against your company in the last five years in relation to the product or similar services to those proposed in the vendor's response to this RFP. Vendors shall list the status of each lawsuit and any outcomes that have occurred.

There have been no lawsuits brought against CSI in the last five years, in relation to products or services described in this RFP Response.

Tygielski & Associates, P.A.

Certified Public Accountants

110 North Bumby Avenue, Orlando, Florida 32803 (407)228-2888 fax (407)228-3888

To the Shareholders
Sal Johnson & Associates, Inc.
d/b/a Computing Systems Innovations
Apopka, Florida

We have compiled the accompanying Balance Sheet of Sal Johnson & Associates Inc., as of December 31, 2008 and the related statement of Revenue and Expense-Income Tax Basis for the year then ended, in accordance with standards established by the American Institute of Certified Public Accountants. The financial statements have been prepared on the accounting basis used by the corporation for federal income tax purposes, which is a comprehensive basis of accounting other than generally accepted accounting principles.

A compilation is limited to presenting in the form of financial statements information that is the representation of management. We have not audited or reviewed the accompanying financial statements and, accordingly, do not express an opinion or any other form of assurance on them.

Management has elected to omit substantially all of the disclosures ordinarily included in financial statements prepared on the income tax basis of accounting. If the omitted disclosures were included in the financial statements, they might influence the user's conclusions about the corporation's assets, liabilities, equity, revenue, and expenses. Accordingly, these financial statements are not designed for those who are not informed about such matters.

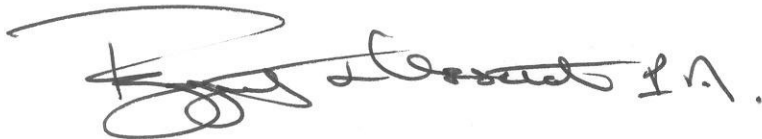

January 28, 2009

THIS PAGE CONTAINS CONFIDENTIAL INFORMATION

Sal Johnson and Associates Inc
Balance Sheet
December 31, 2008

ASSETS	
Current Assets	
Checking/Savings	
Cash	\$ 5,812
Accounts Receivable	1,899,035
Other Current Assets	30,503
Total Current Assets	<u>1,935,350</u>
Fixed Assets	
Property	2,999,902
Accumulated Depreciation	(759,247)
Net Fixed Assets	<u>2,240,655</u>
Other Assets	
Other Assets	13,314
Total Other Assets	<u>13,314</u>
TOTAL ASSETS	<u><u>\$ 4,189,319</u></u>
LIABILITIES & EQUITY	
Liabilities	
Current Liabilities	
Accounts Payable	\$ 41,215
Other Current Liabilities	32,978
Total Current Liabilities	<u>74,193</u>
Mortgage Payable	1,565,512
Note Payable	55,102
Other Liabilities	-
Total Long Term Liabilities	<u>1,620,614</u>
Total Liabilities	<u>1,694,807</u>
Equity	
Common Stock	1,000
Additional Paid-In Capital	31,443
Retained Earnings	1,804,847
Shareholder Distributions	(216,575)
Net Income	873,797
TOTAL LIABILITIES & EQUITY	<u><u>2,494,512</u></u>
	<u><u>\$ 4,189,319</u></u>

THIS PAGE CONTAINS CONFIDENTIAL INFORMATION

Sal Johnson and Associates Inc
Statement of Revenue and Expenses-Income Tax Basis
For the year ended 2008

Revenue	<u>\$ 7,874,920</u>
Cost of Goods Sold	<u>5,009,841</u>
Gross Profit	<u>2,865,079</u>
Overhead	
Office Supplies	53,155
Depreciation & Amortization	75,154
Trade Show Expenses	83,422
Rent	92,609
Taxes	131,355
Insurance	135,395
Advertising	192,032
Wages	206,617
Travel & Entertainment	354,086
Other General Admin Expenses	<u>667,457</u>
Total Expenses	<u>1,991,282</u>
Net Income	<u><u>\$ 873,797</u></u>

THIS PAGE CONTAINS CONFIDENTIAL INFORMATION

See Accountants' Compilation Report

TYGIELSKI & ASSOCIATES, P.A.
CERTIFIED PUBLIC ACCOUNTANTS

110 North Bumby Avenue • Orlando, Florida 32803 • (407) 228-2888 • Fax (407) 228-3888

To the shareholders
Sal Johnson & Associates, Inc.
d/b/a Computing Systems Innovations
Apopka, Florida

We have compiled the accompanying Balance Sheet of Sal Johnson & Associates, Inc., as of December 31, 2009 and the related Statement of Revenue and Expense-Income Tax Basis for the year then ended, in accordance with the standards established by the American Institute of Certified Public Accountants. The financial statements have been prepared on the accounting basis used by the corporation for federal income tax purposes, which is a comprehensive basis of accounting other than generally accepted accounting principles.

A compilation is limited to presenting in the form of financial statements information that is the representation of management. We have not audited or reviewed the accompanying financial statements and, accordingly, do not express an opinion or any other form of assurance on them.

Management has elected to omit substantially all of the disclosures ordinarily included in financial statements prepared on the income tax basis of accounting. If the omitted disclosures were included in the financial statements, they might influence the user's conclusions about the corporation's assets, liabilities, equity, revenue, and expenses. Accordingly, this financial statement is not designed for those who are not informed about such matters.

Tygielski & Associates, P.A.

October 15, 2010

THIS PAGE CONTAINS CONFIDENTIAL INFORMATION

Sal Johnson and Associates Inc
Balance Sheet
December 31, 2009

ASSETS	
Current Assets	
Checking/Savings	
Cash	\$ 8,558
Accounts Receivable	821,069
Other Current Assets	30,503
Loans to Shareholders	<u>279,567</u>
Total Current Assets	<u>1,139,697</u>
Fixed Assets	
Property	3,124,124
Accumulated Depreciation	<u>(1,183,184)</u>
Net Fixed Assets	1,940,940
Other Assets	
Other Assets	<u>11,684</u>
Total Other Assets	<u>11,684</u>
TOTAL ASSETS	<u><u>\$ 3,092,321</u></u>
LIABILITIES & EQUITY	
Liabilities	
Current Liabilities	
Accounts Payable	\$ 75,394
Note Payable < 1 Year	300,000
Other Current Liabilities	<u>14,452</u>
Total Current Liabilities	389,846
Mortgage Payable	1,489,521
Notes Payable > 1 Year	<u>114,768</u>
Total Long Term Liabilities	<u>1,604,289</u>
Total Liabilities	<u>1,994,135</u>
Equity	
Common Stock	1,000
Additional Paid in Capital	31,443
Retained Earnings	1,050,304
Shareholder Distributions	(233,318)
Net Income	<u>248,757</u>
Total Equity	<u>1,098,186</u>
TOTAL LIABILITIES & EQUITY	<u><u>\$ 3,092,321</u></u>

THIS PAGE CONTAINS CONFIDENTIAL INFORMATION

See Accountants' Compilation Report

Sal Johnson and Associates Inc
Statement of Revenue and Expenses-Income Tax Basis
For Year Ended 2009

Revenue	\$ 6,410,704
Cost of Goods Sold	<u>3,341,429</u>
Gross Profit	<u>3,069,275</u>
Overhead	
Office Supplies	75,134
Depreciation & Amortization	205,203
Trade Show Expenses	100,916
Rent	134,845
Taxes & Licenses	175,909
Insurance	198,616
Advertising	175,222
Wages	1,027,810
Travel & Entertainment	237,320
Other General Admin Expenses	<u>489,543</u>
Total Expenses	<u>2,820,518</u>
Net Income	<u><u>\$ 248,757</u></u>

THIS PAGE CONTAINS CONFIDENTIAL INFORMATION

See Accountants' Compilation Report

Tygielski & Associates, P.A.

Certified Public Accountants

110 North Bumby Avenue, Orlando, Florida 32803 (407)228-2888 fax (407)228-3888

To the Shareholders
Sal Johnson & Associates, Inc.
d/b/a Computing Systems Innovations
Apopka, Florida

We have compiled the accompanying statement of assets, liabilities, and equity-income tax basis of Sal Johnson & Associates Inc., as of December 31, 2010 and the related statements of revenue and expense-income tax basis for the year then ended, in accordance with standards established by the American Institute of Certified Public Accountants. The financial statements have been prepared on the accounting basis used by the corporation for federal income tax purposes, which is a comprehensive basis of accounting other than generally accepted accounting principles.

A compilation is limited to presenting in the form of financial statements information that is the representation of management. We have not audited or reviewed the accompanying financial statements and, accordingly, do not express an opinion or any other form of assurance on them.

Management has elected to omit substantially all of the disclosures ordinarily included in financial statements ordinarily included in financial statements presented in accordance with tax basis of accounting. If the omitted disclosures were included in the financial statements, they might influence the user's conclusions about the corporation's assets, liabilities, equity, revenue, and expenses. Accordingly, these financial statements are not designed for those who are not informed about such matters.

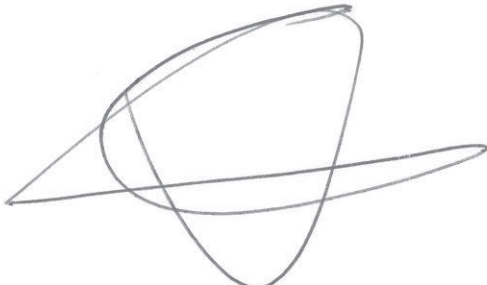
A handwritten signature in black ink, consisting of several overlapping loops and a long horizontal stroke extending to the left.

August 25, 2010

Sal Johnson and Associates Inc.
Balance Sheet
December 31, 2010

ASSETS

Current Assets	
Checking/Savings	
Cash	\$7,657
Accounts Receivable	1,327,765
Loans to Shareholders	210,442
Total Current Assets	\$1,545,864
Fixed Assets	
Property	3,132,629
Accumulated Depreciation	(1,258,879)
Net Fixed Assets	1,873,750
Other Assets	
Other Assets	10,869
Total Other Assets	10,869
TOTAL ASSETS	\$3,430,483

LIABILITIES & EQUITY

Liabilities	
Current Liabilities	
Accounts Payable	\$451,461
Note Payable < 1 Year	296,000
Other Current Liabilities	106,415
Total Current Liabilities	853,876
Mortgage Payable	1,407,488
Notes Payable > 1 Year	74,171
Total Long Term Liabilities	1,481,659
Total Liabilities	2,335,535
Equity	
Common Stock	1,000
Additional Paid in Capital	31,443
Retained Earnings	1,065,743
Shareholder Distributions	(294,433)
Net Income	291,195
Total Equity	1,094,948
TOTAL LIABILITIES & EQUITY	\$3,430,483

See Accountant's Compilation Report

THIS PAGE CONTAINS CONFIDENTIAL INFORMATION

Sal Johnson and Associates Inc.
Statement of Revenue and Expenses-Income Tax Basis
For Year Ended 2010

Revenue	\$5,678,337
Cost of Goods Sold	<u>3,606,095</u>
Gross Profit	<u>2,072,242</u>
Overhead	
Office Supplies	33,331
Depreciation & Amortization	76,510
Trade Show Expenses	64,259
Rent	124,512
Taxes & Licenses	158,771
Insurance	195,842
Advertising	130,033
Wages	502,301
Travel & Entertainment	352,712
Other General Admin Expenses	142,776
Total Expenses	<u>1,781,047</u>
Net Income	<u><u>\$291,195</u></u>

See Accountant's Compilation Report

THIS PAGE CONTAINS CONFIDENTIAL INFORMATION



Independent Accountant's Compilation Report

To the Shareholders
Sal Johnson & Associates, Inc.
Apopka, FL

We have compiled the accompanying balance sheet of Sal Johnson & Associates, Inc. (an S Corporation) as of December 31, 2011, and the related statement of income and retained earnings for the year then ended. We have not audited or reviewed the accompanying financial statements and, accordingly, do not express an opinion or provide any assurance about whether the financial statements are in accordance with accounting principles generally accepted in the United States of America.

Management is responsible for the preparation and fair presentation of the financial statements in accordance with accounting principles generally accepted in the United States of America and for designing, implementing, and maintaining internal control relevant to the preparation and fair presentation of the financial statements.

Our responsibility is to conduct the compilation in accordance with Statements on Standards for Accounting and Review Services issued by the American Institute of Certified Public Accountants. The objective of a compilation is to assist management in presenting financial information in the form of financial statements without undertaking to obtain or provide any assurance that there are no material modifications that should be made to the financial statements.

Management has elected to omit substantially all of the disclosures and the statement of cash flows required by accounting principles generally accepted in the United States of America. If the omitted disclosures and the statement of cash flows were included in the financial statements, they might influence the user's conclusions about the Company's financial position, results of operations, and cash flows. Accordingly, the financial statements are not designed for those who are not informed about such matters.

Borcheck & Gase LLC

May 9, 2013

Sal Johnson and Associates, Inc.
Balance Sheet
As of December 31, 2011

Assets

Current Assets

Cash	\$ 54,073
Accounts receivable	<u>1,996,332</u>
Total Current Assets	<u>2,050,405</u>

Property and Equipment

Buildings & land	2,036,280
Computer & office equipment	1,217,369
Software	9,917
Vehicles	89,582
Accumulated depreciation	<u>(1,538,260)</u>
Total Property and Equipment	<u>1,814,888</u>

Other Assets

Loan costs, net	14,894
Deposits	<u>1,728</u>
Total Other Assets	<u>16,622</u>

Total Assets	<u><u>\$ 3,881,915</u></u>
---------------------	----------------------------

See independent accountant's compilation report

Sal Johnson and Associates, Inc.
Balance Sheet - Continued
As of December 31, 2011

Liabilities and Stockholders' Equity

Current Liabilities

Accounts payable	\$ 282,579
Note payable - current portion	188,611
Other current liabilities	<u>104,150</u>
Total Current Liabilities	575,340

Long Term liabilities

Note payable less current portion	<u>1,309,564</u>
Total Long Term Liabilities	<u>1,309,564</u>

Total Liabilities

Stockholders' Equity

Common stock	1,000
Additional paid-in capital	31,443
Retained earnings	<u>1,964,568</u>
Total Stockholders' Equity	<u>1,997,011</u>

Total Liabilities and Stockholders' Equity

\$ 3,881,915

See independent accountant's compilation report

Sal Johnson and Associates, Inc.
Statement of Income and Retained Earnings
For the Year Ended December 31, 2011

Revenue	
Gross Sales	\$ 7,935,061
Total Revenue	7,935,061
Cost of Goods Sold	4,206,155
Gross Profit	3,728,906
Operating Expenses	
Salaries and wages	375,837
Travel and education	290,841
Depreciation and amortization	280,628
Insurance	246,856
Advertising	246,495
Other general and administrative	208,814
Office supplies and equipment rental	114,478
Rent	112,237
Utilities	99,350
Tradeshaw expenses	91,631
Taxes and licenses	35,090
Professional fees	20,922
Total Operating Expenses	2,123,179
Other Expenses	
Interest expense	104,823
Total Other Expenses	104,823
Net Income	1,500,904
Retained Earnings - Beginning of Year	1,062,505
Distributions	(598,841)
Retained Earnings - End of Year	\$ 1,964,568

See independent accountant's compilation report



Independent Accountant's Compilation Report

To the Shareholders
Sal Johnson & Associates, Inc.
Apopka, FL

We have compiled the accompanying balance sheet of Sal Johnson & Associates, Inc. (an S Corporation) as of December 31, 2012, and the related statement income and retained earnings for the year then ended. We have not audited or reviewed the accompanying financial statements and, accordingly, do not express an opinion or provide any assurance about whether the financial statements are in accordance with accounting principles generally accepted in the United States of America.

Management is responsible for the preparation and fair presentation of the financial statements in accordance with accounting principles generally accepted in the United States of America and for designing, implementing, and maintaining internal control relevant to the preparation and fair presentation of the financial statements.

Our responsibility is to conduct the compilation in accordance with Statements on Standards for Accounting and Review Services issued by the American Institute of Certified Public Accountants. The objective of a compilation is to assist management in presenting financial information in the form of financial statements without undertaking to obtain or provide any assurance that there are no material modifications that should be made to the financial statements.

Management has elected to omit substantially all of the disclosures and the statement of cash flows required by accounting principles generally accepted in the United States of America. If the omitted disclosures and the statement of cashflows were included in the financial statements, they might influence the user's conclusions about the Company's financial position, results of operations, and cash flows. Accordingly, the financial statements are not designed for those who are not informed about such matters.

Borcheck & Gase LLC

August 8, 2013

Sal Johnson and Associates, Inc.
Balance Sheet
December 31, 2012

Assets

Current Assets

Cash	\$ 126,979
Accounts receivable	810,979
Total Current Assets	<u>937,958</u>

Property and Equipment

Buildings & land	2,036,280
Computer & office equipment	479,551
Vehicles	89,582
Accumulated depreciation	(817,919)
Total Property and Equipment	<u>1,787,494</u>

Other Assets

Loan costs, net	13,580
Deposits	1,728
Total Other Assets	<u>15,308</u>

Total Assets	<u><u>\$ 2,740,760</u></u>
---------------------	----------------------------

See independent accountant's compilation report

Sal Johnson and Associates, Inc.
Balance Sheet - Continued
December 31, 2012

Liabilities and Stockholders' Equity

Current Liabilities	
Note payable - current portion	\$ 168,740
Other current liabilities	45,948
Total Current Liabilities	<u>214,688</u>
Long Term liabilities	
Note payable less current portion	1,141,234
Total Long Term Liabilities	<u>1,141,234</u>
Total Liabilities	1,355,922
Stockholders' Equity	
Common stock	1,000
Additional paid-in capital	31,443
Retained earnings	1,352,395
Total Stockholders' Equity	<u>1,384,838</u>
Total Liabilities and Stockholders' Equity	<u><u>\$ 2,740,760</u></u>

See independent accountant's compilation report

Sal Johnson and Associates, Inc.
Statement of Income and Retained Earnings
For the Year Ended December 31, 2012

Revenue	
Gross Sales	\$ 6,201,554
Total Revenue	6,201,554
Cost of Goods Sold	4,204,465
Gross Profit	1,997,089
Operating Expenses	
Travel and education	404,120
Salaries and wages	378,225
Advertising	297,185
Insurance	262,429
Other general and administrative	248,227
Office supplies and equipment rental	193,711
Rent	109,667
Depreciation and amortization	100,887
Tradeshows expenses	99,888
Utilities	90,113
Taxes and licenses	49,831
Professional fees	29,569
Total Operating Expenses	2,263,852
Other Expenses	
Interest expense	88,556
Total Other Expenses	88,556
Net Income	(355,319)
Retained Earnings - Beginning of Year	1,964,568
Distributions	(256,854)
Retained Earnings - End of Year	\$ 1,352,395

See independent accountant's compilation report

Note: FY 2013 statement has not been finalized as of this time

Form **7004**

(Rev. December 2012)

Department of the Treasury
Internal Revenue Service

Application for Automatic Extension of Time To File Certain Business Income Tax, Information, and Other Returns

► **File a separate application for each return.**

► **Information about Form 7004 and its separate instructions is at www.irs.gov/form7004.**

OMB No. 1545-0233

**Print
or
Type**

Name SAL JOHNSON & ASSOCIATES INC. COMPUTING SYSTEM INNOVATIONS	Identifying number 59-3512778
Number, street, and room or suite no. (If P.O. box, see instructions.) 791 PIEDMONT-WEKIWA ROAD	
City, town, state, and ZIP code (If a foreign address, enter city, province or state, and country (follow the country's practice for entering postal code)). APOPKA FL 32703	

Note. File request for extension by the due date of the return for which the extension is granted. See instructions before completing this form.

Part I Automatic 5-Month Extension

1a Enter the form code for the return that this application is for (see below) 25

Application Is For:	Form Code	Application Is For:	Form Code
Form 1065	09	Form 1041 (estate other than a bankruptcy estate)	04
Form 8804	31	Form 1041 (trust)	05

Part II Automatic 6-Month Extension

b Enter the form code for the return that this application is for (see below) 25

Application Is For:	Form Code	Application Is For:	Form Code
Form 706-GS(D)	01	Form 1120-ND (section 4951 taxes)	20
Form 706-GS(T)	02	Form 1120-PC	21
Form 1041 (bankruptcy estate only)	03	Form 1120-POL	22
Form 1041-N	06	Form 1120-REIT	23
Form 1041-QFT	07	Form 1120-RIC	24
Form 1042	08	Form 1120S	25
Form 1065-B	10	Form 1120-SF	26
Form 1066	11	Form 3520-A	27
Form 1120	12	Form 8612	28
Form 1120-C	34	Form 8613	29
Form 1120-F	15	Form 8725	30
Form 1120-FSC	16	Form 8831	32
Form 1120-H	17	Form 8876	33
Form 1120-L	18	Form 8924	35
Form 1120-ND	19	Form 8928	36

- 2 If the organization is a foreign corporation that does not have an office or place of business in the United States, check here
- 3 If the organization is a corporation and is the common parent of a group that intends to file a consolidated return, check here
- If checked, attach a statement, listing the name, address, and Employer Identification Number (EIN) for each member covered by this application.

Part III All Filers Must Complete This Part

4 If the organization is a corporation or partnership that qualifies under Regulations section 1.6081-5, check here

5a The application is for calendar year 20**13**, or tax year beginning _____, and ending _____

b **Short tax year.** If this tax year is less than 12 months, check the reason: Initial return Final return
 Change in accounting period Consolidated return to be filed Other (see instructions-attach explanation)

6 Tentative total tax	6	0
7 Total payments and credits (see instructions)	7	0
8 Balance due. Subtract line 7 from line 6 (see instructions)	8	0

For Privacy Act and Paperwork Reduction Act Notice, see separate Instructions.

Form **7004** (Rev. 12-2012)

THIS PAGE CONTAINS CONFIDENTIAL INFORMATION

3. Project Plan and Methodology

Implementation Schedule/Work Plan

Describe your implementation planning process in general. Describe the roles your company will play in implementation and the roles the courts' and State's employees will play. Provide details of your approach to project management.

Trey Pickett will be the CSI team's project manager and responsible for coordination of all CSI team efforts on the AOC redaction project. Mr. Pickett has personal experience in the project management of several concurrent enterprise redaction projects across multiple jurisdictions. The cumulative total images processed by projects **Mr. Pickett has been responsible for delivering on time, on budget, and with contracted levels of accuracy having been met and customer verified is over 400 million images.** The project management approach he will use is based on the Project Management Institute (PMI) framework and extensive experience managing technology deployments for enterprise organizations. This approach serves as a template that is customized and adapted to meet the specific requirements of each customer. The project team will apply these practices throughout the life cycle of the AOC redaction project, and as part of their normal daily work reporting process said project framework will provide automatic updates to a centralized project plan for immediate review of current project status.

Continuous formalized communication is the cornerstone of CSI's on-going customer support. Communication is conducted through weekly status meetings, monthly status reports, formal project reviews with senior leadership, and real-time access to project data. CSI will develop a project-specific plan from the information provided in the RFP and our extensive experience, and will provided for your review. This project plan will serve as the key communication device for articulating the project status and future goals. Using a structured project management process in redaction processing helps **identify risk, and pre-defined contingencies** combat project failure.

CSI makes **extensive use of MS-Project Server for all CSI staff** tasks and will provide secure web browser access to AOC for its individual redaction project portal. A screen shot is provided for you to review the categories of information that will be accessible for your remote view into Intellidact processing. The benefit to the entire team will be **instant access to all current project information available anytime and from anywhere** available outside of project meetings, with information being organized and maintained in a central location, and only a browser required for access. Such real-time direct access to project information includes but is not limited to **the current up-to-date project plan**, all project announcements, issues, risks, documented discussions, deliverables, support documents, questionable identity information images for customer circulation and decision, as well as **posted accuracy reports.** Accounts provided may also be set to provide real-time notification of any changes posted to the project by CSI team members, and notification via email or RSS feeds. This additional feature using CSI project management provides organized and documented access to all project decisions. CSI risk management methodology includes **professional project management, a methodical and proven implementation**, easy access to **up-to-date project status** outside of scheduled project meetings, and ongoing customer support.

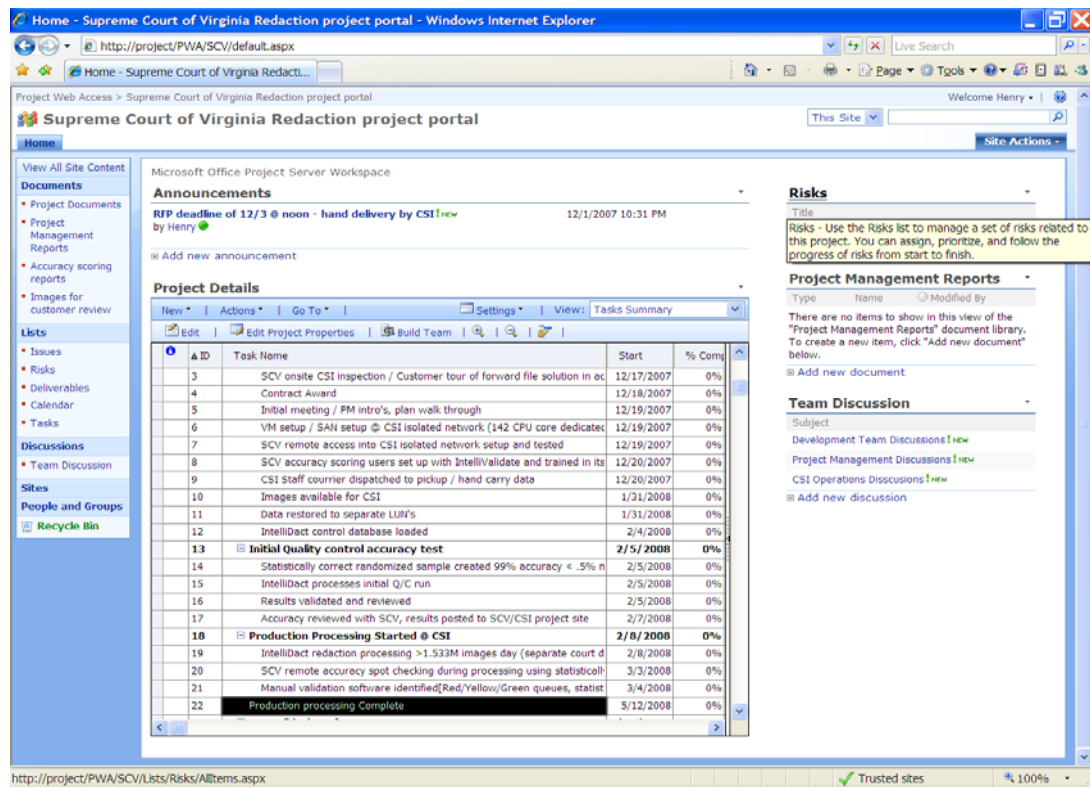

CSI Sample Project Management Portal

CSI looks forward to working with AOC's team for integration efforts of scanning, extraction of unstructured data and creation of redacted images, and performing any other task required to make the project a **showcase project** that all stakeholders can be proud of.

CSI is unique in that, and has the ability to work without conflict within the land records and court market spaces, as it is not a provider of land record or court software, and as such does not compete with their core software competencies. Our vendor-neutral culture has allowed IntelliDact to be interfaced with more than 150 repositories, processing over 4.5 Billion images from a multitude of software vendors.

Project Plan Documentation

Provide a typical high-level single court implementation schedule listing vendor resources to be deployed, required court and State resources and any other resources that may be assigned to tasks in the project plan. The schedule should include project milestones with target dates measured from project start date. The winning vendor will be expected to work with the AOC project management group to develop a detailed pilot project plan consisting of tasks, start and end dates, assignees, dependencies and status prior to project kick-off.

ID	Task Name	Duration	Start	Finish	Predecessors	Resource Names
1	Intellidact Backfile Redaction (at CSI Secure Datacenter)	56.5 days	Fri 8/29/14	Mon 11/17/14		
2	Kickoff Calls	51 days	Fri 8/29/14	Fri 11/7/14		
3	Introduction Call	1 hr	Fri 8/29/14	Fri 8/29/14		CSI PM,Client PM,Client
4	Establish Project Schedule	1 day	Fri 8/29/14	Mon 9/1/14	3	CSI PM,Client PM,Client
5	Project Startup Call (Review SOW / Plan)	2 hrs	Mon 9/1/14	Mon 9/1/14	4	CSI PM,Client PM,Client
6						
7	Processing for up to 10 million images	51 days	Fri 8/29/14	Fri 11/7/14		
8	Ship Images for Processing to Secure Datacenter	1 day	Fri 8/29/14	Fri 8/29/14		Client
9	Images Received and Inventoried	1 day	Mon 9/1/14	Mon 9/1/14	8	CSI TM
10	Load Images	10 days	Tue 9/2/14	Mon 9/15/14	9	CSI LOAD
11	Perform Cert Run	5 days	Tue 9/16/14	Mon 9/22/14	10	CSI TM
12	Review Cert Run with Client	1 day	Tue 9/23/14	Tue 9/23/14	11	CSI PM,Client PM,Client
13	Process Images	12 days	Wed 9/24/14	Thu 10/9/14	12	CSI GRID
14	Validate Images (15%)	12 days	Fri 10/10/14	Mon 10/27/14	13	CSI VALIDATORS
15	Export Redacted Output	7 days	Tue 10/28/14	Wed 11/5/14	14	CSI EXPORT
16	CSI QC of Exported Work	1 day	Thu 11/6/14	Thu 11/6/14	15	CSI TM
17	Ship Redacted Output to Customer	1 day	Fri 11/7/14	Fri 11/7/14	16	CSI TM
18	Initial Delivery Acceptance	0 days	Fri 11/7/14	Fri 11/7/14	17	Client PM
19						
20	Client Review of Delivered Work	5 days	Mon 11/10/14	Fri 11/14/14	18	Client
21	Intellidact Backfile Final Acceptance	0 days	Fri 11/14/14	Fri 11/14/14	20	Client PM
22	Intellidact Backfile Delivery Closure Meeting	0.5 days	Mon 11/17/14	Mon 11/17/14	21	CSI PM,Client PM,Client,CSI TM
23	Project Closure	0 days	Mon 11/17/14	Mon 11/17/14	22	

ID	Task Name	Duration	Start	Finish	Predecessors	Resource Names
1	Intellidact Redaction Integration	19.38 days	Fri 8/29/14	Thu 9/25/14		
2	Kickoff Calls	1.63 days	Fri 8/29/14	Mon 9/1/14		
3	Introduction Call	1 hr	Fri 8/29/14	Fri 8/29/14		CSI PM,Client PM,Client,CSI TM
4	Infrastructure Discovery Call	2 hrs	Fri 8/29/14	Fri 8/29/14	3	CSI PM,CSI TM,Client
5	Establish Project Schedule	1 day	Fri 8/29/14	Mon 9/1/14	4	CSI PM,CSI TM,Client
6	Project Startup Call (Review SOW / Plan)	2 hrs	Mon 9/1/14	Mon 9/1/14	5	CSI PM,Client PM,Client,CSI TM
7						
8	Base Intellidact System Delivery	1.25 days	Mon 9/1/14	Tue 9/2/14		
9	Infrastructure Readiness Review	0.25 days	Mon 9/1/14	Mon 9/1/14	6	CSI TM,Client
10	Infrastructure Readiness Remediation Tasks	1 day	Mon 9/1/14	Tue 9/2/14	9	Client
11	Infrastructure Readiness Acceptance	0 days	Tue 9/2/14	Tue 9/2/14	10	CSI TM,Client
12	Base Intellidact System Deployment - Dev/Test Environmen	3 days	Tue 9/2/14	Fri 9/5/14		
13	Base Intellidact System Installation	1.5 days	Tue 9/2/14	Thu 9/4/14	11	CSI TM
14	Exercise and Test Base Intellidact System Installation	0.25 days	Thu 9/4/14	Thu 9/4/14	13	CSI TM,Client
15	Review Base Intellidact System Test Results	0.25 days	Thu 9/4/14	Thu 9/4/14	14	CSI TM,Client
16	Base Intellidact System Installation and Configuration Remediation	1 day	Thu 9/4/14	Fri 9/5/14	15	CSI TM
17	Base Intellidact System Delivery Final Acceptance	0 days	Fri 9/5/14	Fri 9/5/14	16	Client PM
18						
19	Interface Delivery and Integration to Base Intellidact System	4.5 days	Fri 9/5/14	Fri 9/12/14		
20	Delivery of Interface(s)	1 day	Fri 9/5/14	Mon 9/8/14	17	CSI TM
21	Delivery of Intellidact Workflows	0.5 days	Mon 9/8/14	Tue 9/9/14	20	CSI TM
22	Delivery of Intellidact Redaction Validation	0.5 days	Tue 9/9/14	Tue 9/9/14	21	CSI TM
23	Delivery of Optional Intellidact Validation Document Management	1 day	Tue 9/9/14	Wed 9/10/14	22	CSI TM
24	Exercise and Test Intellidact Interface and Integration Installation	0.25 days	Wed 9/10/14	Thu 9/11/14	23	CSI TM,Client
25	Review Intellidact Interface and Integration Installation	0.25 days	Thu 9/11/14	Thu 9/11/14	24	CSI PM,Client PM,Client,CSI TM
26	Intellidact Interface and Integration Installation and Configuration Remediation	1 day	Thu 9/11/14	Fri 9/12/14	25	CSI TM,Client
27	Intellidact Interface and Integration Installation Final Acceptance	0 days	Fri 9/12/14	Fri 9/12/14	26	Client PM
28						
29	Intellidact Redaction Integration System Testing/Pilot	7.5 days	Fri 9/12/14	Tue 9/23/14		
30	Joint System Demonstration Call	0.25 days	Fri 9/12/14	Fri 9/12/14	27	Client,CSI TM
31	IntelliValidation Client Training	0.25 days	Fri 9/12/14	Fri 9/12/14	30	Client,CSI TM
32	Develop Pilot Test Plan and Test Groups	0.5 days	Fri 9/12/14	Mon 9/15/14	31	Client,CSI TM
33	Test Group execution of Test Plan	5 days	Mon 9/15/14	Mon 9/22/14	32	Client
34	Pilot Testing Remediation Tasks	1 day	Mon 9/22/14	Tue 9/23/14	33	Client,CSI TM
35	Intellidact System Pilot Review	0.5 days	Tue 9/23/14	Tue 9/23/14	34	CSI PM,Client PM,Client,CSI TM
36	Intellidact System Pilot Agreement and Acceptance	0 days	Tue 9/23/14	Tue 9/23/14	35	Client PM
37	Intellidact System Production System Rollout	1 day	Tue 9/23/14	Wed 9/24/14	36	CSI TM,Client
38	Base Intellidact Production System Delivery Final Acceptance	0 days	Wed 9/24/14	Wed 9/24/14	37	Client PM
39	Intellidact Redaction Integration Delivery Closure Meeting	0.5 days	Wed 9/24/14	Thu 9/25/14	38	CSI PM,Client PM,Client,CSI TM
40	Project Closure	0 days	Thu 9/25/14	Thu 9/25/14	39	

System Modification/Customization/Integration Plan

Assuming that your product will require some customization and integration with case and document management systems for deployment in Arkansas, describe your approach to system customization and integration. Include a statement of how the State should request product customizations or enhancements, how they will be delivered, how customization effort is estimated, and any other pertinent information.

Describe the process by which you decide whether a modification will be made to your base package, or whether the modification is a custom modification. Explain the impact product upgrades will have on custom modifications. Describe the Quality Assurance/Testing processes you follow for determining whether an upgrade or custom modification is suitable for release.

Because of the diverse interface support (i.e. Intellidact enterprise service buss, ECF 4.0/NIEM 3.0 standard information exchange, file drop, and database trigger monitors) we don't foresee integration as a system customization / development issue. If however that State should request product customizations a standard change order process exists that has the State filling out a specific change order request form, CSI engineering analyzing impacts and development work and then the CSI project manager providing design for approval and pricing back to the State.

Development and testing of enhancements is via the standard CSI software development methodology detailed within the section on software development methodology as requested. Delivery of enhancement is via the same automated deployment process that exists for Intellidact software however scheduling of such is upon completion of CSI internal Q/A and does not have to be incorporated within a scheduled software release cycle.

Whether an item is a product upgrade made and provided to the general customer base, or specific to the customer is based on the combination of the suggested enhancement being voted on in the user forum and CSI's product manager review of competitive advantage including such in the base product would be.

Initial Delivery Date

Indicate the earliest date on which you could deliver your off-the-shelf product and services, and begin implementation. Also include a range of subsequent possible implementation dates, in the event that the State is unable to begin implementation on your earliest delivery and implementation date.

Initial project plan introduction meetings can be scheduled within 2 weeks of any contract execution. Delivery can start immediately after that, however onsite installation is usually determined by availability of customer hardware. CSI has sufficient staff bandwidth to make subsequent start dates available without project start delay.

Training Plan & Schedule

Describe in detail your proposed training plan (both initial and on-going) for users, system administrators, and AOC and court staff. Describe your approach to end-user training and any training you will provide to AOC and court staff. Discuss whether training will occur remotely, on-site, or out-of-state, and what resources the State or court will be required to provide for training.

CSI uses “train the trainer” methodology whereby a core group of super-users is classroom trained either at user facilities or CSI corporate headquarters. Basic user training occurs as part of the professional services installation and implementation engagement. Remote training within a virtual classroom is available as well. Full documentation is provided in PDF format, and extensive online help is available within the applications themselves.

CSI holds an annual user group conference to highlight new features, provide training sessions, and solicit feedback from our user community. In addition as travel budgets and available time are limited, CSI has an online user community to allow typical user interactions to occur in today’s online world.

Customer Service

Describe your proposed customer service plan, including expected response times broken down by priority levels, hours of operation and emergency availability, and services included and excluded. If alternate plans exist, please explain in detail. Explain to what extent the plan supports databases and software, client applications, system administration and operations scripts and utility programs that are vendor-produced or vendor-supplied third-party tools. Explain the State’s responsibilities with respect to support.

Support

For daily processing support we utilize state of the art technology to assist our customers. CSI maintains hotline toll free support, a web support portal, WebEx remote support, and an “email to case” capability of obtaining support services. CSI utilizes Microsoft CRM with automated workflow to ensure proper support case escalations and management notifications to provide for strict SLA response compliance. CSI’s support staff is thoroughly trained and operates 7x24x365 with hours outside of 5x12 provided for by on call support staff. All business hours support, whether from EST to PST, is provided for by working staff.

CSI provides ongoing support via its automated support portal (support.csisoft.com), email, or toll free access (877-992-2900). CSI’s support system is fully automated to provide for automated assignments, SLA response time commitments, customer notifications, escalation to team lead, and management notifications required to provide best in class support for CSI products. CSI believes firmly in direct assignment of support cases to development team members to provide the quickest customer response and exchange of accurate information.

Problem Determination/Resolution Procedures

The first stage in problem determination/resolution procedures is to have the support issue automatically assigned to the responsible CSI support team member based upon the customer selected product. This is accomplished automatically via Microsoft CRM workflow. Once this occurs, both the customer and the assigned CSI engineer are notified of a new issue.

The CSI team member will call the customer to validate the information provided and attempt a remote debug session to gather any information needed to analyze the problem. If such cannot be attempted on the customer's production system, CSI will next attempt to duplicate the problem using the customer's test system to duplicate the problem.

Once the problem is duplicated and validated to not be an operational or configuration issue, the CSI team member will inform the customer of such. The issue is now moved to CSI's automated bug tracking system (JIRA) and a developer is assigned to analyze and resolve the issue.

CSI's development and testing infrastructure is completely virtualized with CSI using both source code control system (Subversion) and production environment versioning (VMware Lab manager) to provide the immediate ability to recreate the exact version of software running at the customer site with minimal work by CSI staff.

CSI development staff analyzes the problem, makes appropriate alterations and performs regression testing, then releases the modifications as either a hot fix for the problem or a next version change, pending the severity of the reported problem. If a hot fix is required, the project manager would be notified and is responsible for implementation at the customer site on the Intellidact test/training system. Upon validation by the AOC that the fix was correct, CSI would assist in implementing such in their production environment.

At all stages of analyzing the problem and preparing a fix the customer has access to the status of their issue via the CSI support portal.

Risk Assessment Methodology

Describe your risk assessment and mitigation methodology and how you would apply it to the implementation of your solution.

For all engagements, CSI employs the standard Project Management Institute Issue and Risk Assessment, Management, and Mitigation practices throughout all project management and delivery processes

4. System Features, Upgrades, and Future Functionality

List and Description of System Features

Provide a list and description of system features.

Once the digitized documents are received, Intellidact will perform OCR/ICR/MICR/Eyesight processing using the IntelliGrid and apply any capture/redaction rule sets to perform the associated analytics.

Privacy Fields to be Redacted

Out-of-the-box, Intellidact already has rules for the following privacy fields, which you can select as desired:

- Social Security Numbers
 - nnn-nn-nnnn format (e.g., 123-45-6789)
 - Masked format (e.g., XXX-XX-6789)
- Financial Institution IDs
 - Bank Accounts (including commercial, credit unions, savings & loan, investment, private, etc.)
 - Mutual Fund Accounts
 - Brokerage Accounts (stock/bond/discount)
 - Financial Services Accounts (asset management, etc.)
- Credit Card / Debit Card Numbers
- Minor Name
- Date of Birth
- Federal Tax ID (TIN/EIN) (e.g., 12-3456789)
- Employee Identification Number
- Driver's License Numbers
- Passport Number
- Telephone Number
- Insurance Policy Account Number
- Loan Account Number
- Customer Account Number
- Patient or Health Care Number
- Email Address
- Computer User name
- Passwords
- Personal Identification Numbers

Prior to any redaction processing, CSI will provide a detailed checklist of items (as above) that AOC will **need to consider for redaction**. For example, in some states it is common to embed the SSN within an otherwise innocuous number or ID. Our redaction sign off sheet is the accumulation of our national processing expertise.

Intellidact can perform redaction of portions of personally identifiable information, such as truncating the first 5 digits of an SSN, while leaving the trailing 4 digits exposed. Redaction of specific data per document type (as opposed to complete redaction) is defined on a field type basis (i.e. SSN, credit card number, etc.) as a part of standard system configuration available for administrative user configuration via Intellidact’s modern administrative web user interface. Intellidact also **locates and saves the location of the entire SSN** should redaction of the complete number be required in the future.

*Intellidact Web Administration
setting the redaction size*

*Resultant SSN redaction
of all but last 4 on handprint data*

Before

After

Refining the Rule Set

As Intellidact processes images based upon a set of previously defined rules, it is important that Intellidact rules accurately define what Intellidact is attempting to locate and redact. As such, prior to production processing start, Intellidact’s current rule sets, thoroughly tested on images from a multitude of court filings, land records, and Secretary of State image sources, will be run against a “mathematically correct” sample of AOC’s records. This **statistically correct subset will be a random sample from the entire repository population required to prove 99.95% or greater accuracy** in processing on the batch image population size with less than a .5% margin of error. This subset test will have mandatory Quality Control (“Q/C”) performed on each image by a CSI validation team.

Upon completion of the initial Q/C validation run **CSI will review with AOC staff** that the information to be redacted is correct, as outlined in the RFP and referenced herein, and the **desired level of accuracy has been achieved** from this set. If accuracy shortcomings are identified, CSI will resolve them by performing image analysis and rule set refinements, and start the rule set certification testing from the beginning using the current set of sample images and then an additional random image set until the accuracy achieved is greater than 99.5%.

Intellidact's OCR Engine

Recostar Pro and **Intellidact Eyesight™** are Intellidact's character reading systems (aka "recognition engines"). As we contain features here very unique to CSI we provided additional explanation for your review.

CSI Intellidact has exclusive use of Recostar Pro and as such you will not find Recostar in any other response to your RFP. Recostar has been benchmarked to provide superior character recognition than either the Nuance or Abbyy technologies, with the IRS selecting **Recostar for the largest recognition project in US history, the United States census.**

Unlike other OCR/ICR engines, Recostar provides for both OCR and ICR interpretation of the image data, **and then a voting engine** evaluates on a character by character basis whether the data returned by the machine print engine (OCR) or handprint engine (ICR) is of higher confidence. Recostar then constructs words combining the best character results from either engine. For details of how voting engines improve upon the OCR and ICR process, we have attached a white paper on technical details of such titled *Improving OCR/ICR Results with Expert Voting* in the appendix to our response.

Recostar Pro natively accommodates OCR-A/USASI-A, OCR-B, E-13B/MICR, F7B/ISO/IEC 7811, Handprint (ICR), Check Mark (OMR), and both **1D, 2D and QR barcodes** allowing Intellidact to recognize and **redact privacy information in plain sight but hiding within barcodes.**

OCR-A	1234567890
OCR-B	1234567890
E13B	1234567890 12 3 4 5 6 7 8 9 0
F7B	1234567890

Machine Print Fonts

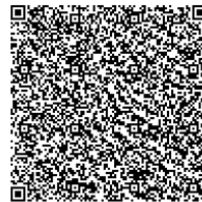

QR Barcode



2D Barcode (PDF417)

In addition to OCR, ICR, and Voting, Recostar **provides for field specific "image enhancement"** prior to the OCR and ICR processing stages that is not possible within other recognition engines. This allows Intellidact to make automatic minute adjustments to enhance/adjust the image and address problems with image quality or orientation that may be affecting only a specific area of the image. Other recognition engines only provide page specific image enhancements or manual setting adjustments that make such not of high value in large volume processing projects, especially those images whose original source was from microfilm conversions.

An example of this is where the majority of text is recognized in normal orientation yet there was some handprint in the margins incorrectly orientated. Intellidact would use Recostar to rotate the fields located in the margins as needed, leaving the remaining text alone and redact such correctly. Such field level image enhancement is absent in less sophisticated character reading engines.

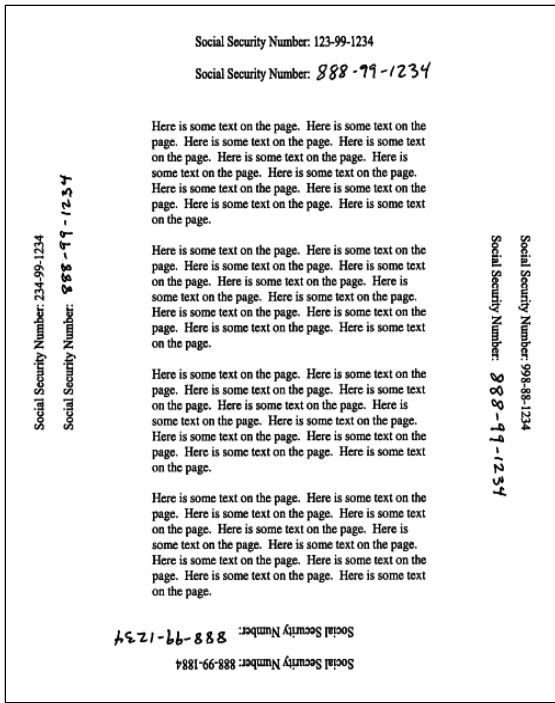

Before - Original image

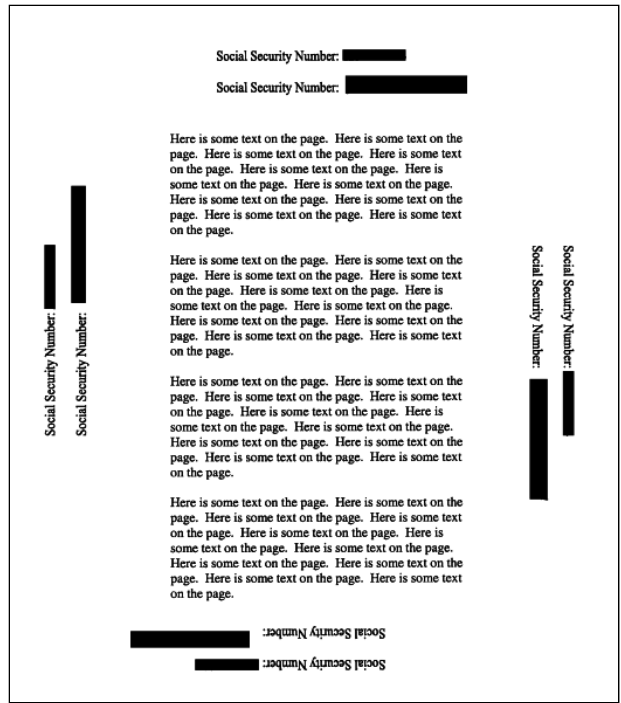

After - Individually Rotated Fields

Image Integrity

CSI follows ISO standards 15489:2001 and ISO 9001:2008 to provide control of documents and records, internal audits of processing, control of non-conforming product/processing, corrective actions, and preventive measures.

As a further step to assist our customers, CSI processes images to ensure that TIFF headers meet TIFF standards, that the files are not of zero length (indicating they have internal damage), and calculates a unique and unalterable checksum that is used to identify the image throughout all stages of processing and storage by CSI. Upon production of any redacted image, CSI performs the same checksum calculation and uses such to ensure the integrity of images processed as well as delivered back to a customer. Intellidact checksums can be provided back to the customer as well so they can audit and control the integrity of images received back from CSI as well.

Correction of Poor Images/Angular redactions

Intellidact processes digital images irrelevant of orientation, size, skew, and image quality. Intellidact's engine provides an orientation detection and auto rotate function that is used to recognize and correct documents that are presented for processing in an incorrect format. In addition, Intellidact also includes advanced deskew, despeckle, line removal with character repair technology. Automatic character erode/grow technology is used to accommodate for images that are not in pristine condition to produce the best possible character recognition rates.

Differentiating ourselves from other vendors, Intellidact has the ability to **correct for images that are in poor quality** and if desired, **provide the higher quality corrected images** back. Such is often useful if the images being processed are from a back file redaction project and the original images were scanned from microfilm/microfiche that did not use advanced image clean up technologies before producing the digital images.

Intellidact's accurate redaction processing of less than ideal images (i.e. poor quality and bad character recognition) is accomplished by fuzzy logic that exists in its redaction candidate location processing. Such accommodates for non-exact pattern matching perfected over several billion processed production images. Images that are identified by automated software below a certain threshold where character recognition would be suspect are set to the required manual validation or the "red Intellidact queue" for mandatory review.

Image Correction example Intellidact deskews images providing clean copy and not requiring redaction operators to draw on angles!

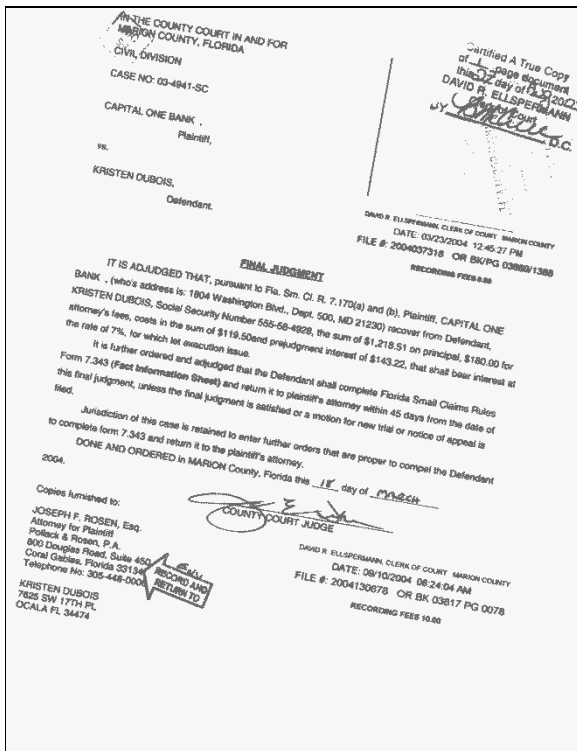

Before – Original image skewed

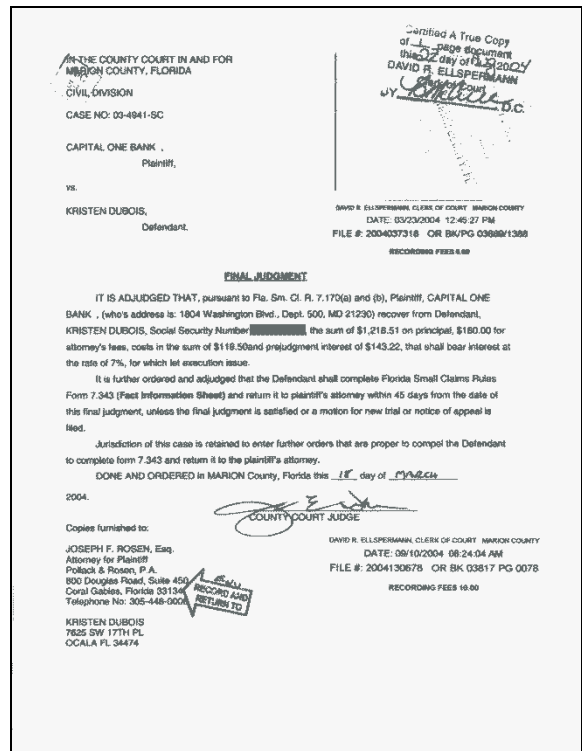

After – Intellidact deskewed and redacted

EyeSight

Unique to CSI's character reading system is **Intellidact Eyesight™**. Eyesight™ was invented by CSI's director of research, Mr. Dean Hough. Mr. Hough was the **co-founder of Kofax** and as such responsible for the invention of the technologies used to scan documents.

In addition to being the only redaction vendor to incorporate the Recostar Pro OCR/ICR/Voting engine that allows us to locate and redact **handprint absent machine print keywords**, Mr. Hough's research team has created an engine that processes an image as a human eye would, allowing us to programmatically process images that are of too poor quality to be processed using OCR/ICR technology. This unique to Intellidact technology is called EyeSight™ and deals with images as pictures not requiring character recognition technology to be effective.

Unlike OCR/ICR engines that can only use character confidence values to guess at what data is problematic in translation, Intellidact Eyesight recognizes "problem data" by performing topographical image analysis to locate and detect image "objects" that produce erroneous OCR/ICR results. Objects such as cursive script, poor quality images, bad handprint are identified and automatically recognized for manual review.

Eyesight allows Intellidact to identify and catch images that would cause privacy data to slip through other systems, without requiring manual inspection of each image to assure such. Where OCR/ICR character recognition engines begin to fail, Eyesight™ provides the technology to ensure quality is maintained without having to apply additional manual labor.

EyeSight™ examples

Eyesight Cursive Script Detection

Eyesight Poor Quality Image Detection

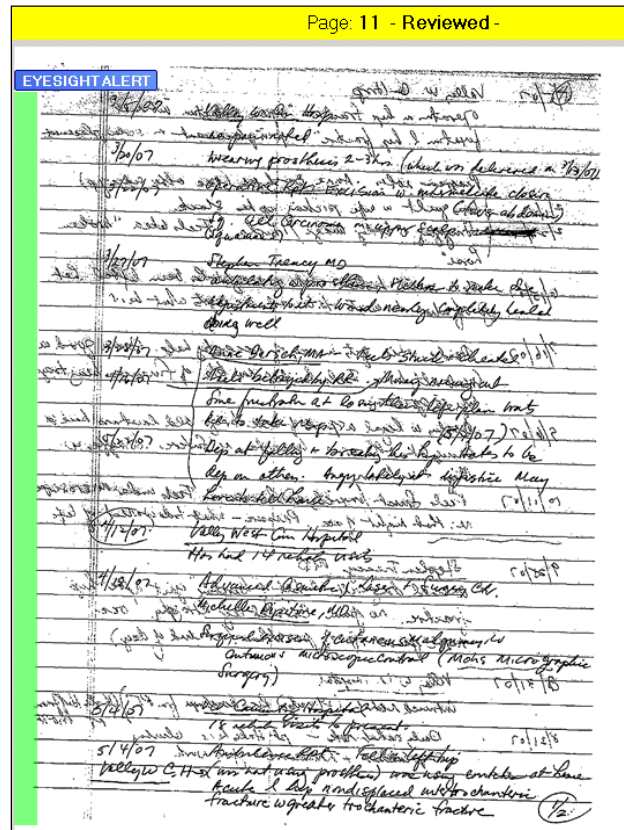
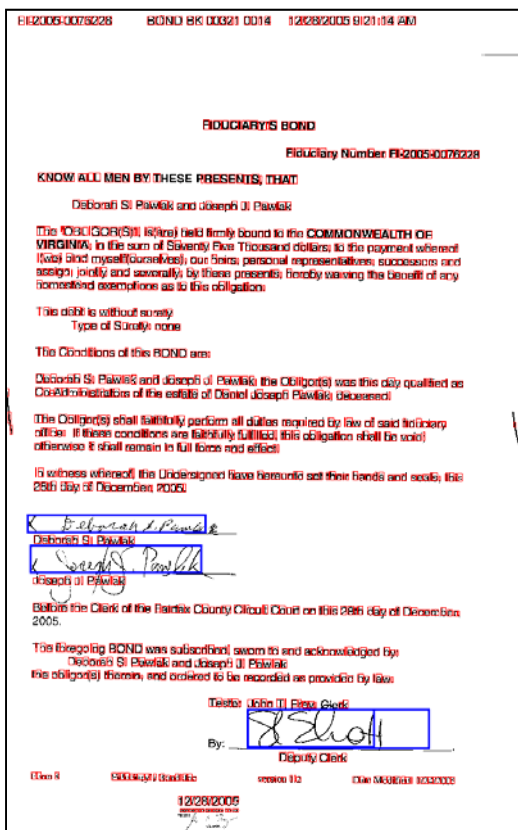

Manual Validation

During automated processing, Intellidact categorizes four colored queue classes upon completion of automated processing, based upon the degrees of difficulty in not only converting characters, but in the complexity of logic used to produce a redaction candidate. The queue classes are red, yellow, green, and gray. Intellidact Document Management (IDM) is responsible for the routing of documents of particular types to subject matter experts as desired for rapid validation/verifications.

- Images placed in the red queue call for mandatory inspection of instrument types where an expected field such as an SSN was not found. Instruments such as death certificates, military discharges, and IRS forms usually require SSNs, however as requirements vary among jurisdictions, Intellidact allows this setting to be easily adjusted.
- Images placed in the yellow queue are those for which Intellidact performed a significant amount of complex logic to identify redaction candidates, or for conditions that could benefit from manual inspection. Images containing account numbers, handprint, cursive script, and ones having identifying keywords – but no relevant data – will appear in the yellow queue. It is important to note that yellow queue images may or may not contain redactions, and IntelliValidate allows the user to select this as one of its many search options in validation processing.
- Images placed in the green queue are those for which Intellidact has had the utmost confidence in finding and redacting eligible fields.
- Images placed in the gray queue are those for which Intellidact has had the utmost confidence in not finding any redactable fields.

IntelliValidate has been judged by the market, and in a commissioned study by San Diego County, to be the most ergonomic and user friendly redaction validation interface on the market. End users with minimal training average more than 6,000 images per day with fewer than 3 mistakes per work day using IntelliValidate. Experienced team leads using IntelliValidate exceed validation of 18,000 images per day, due to IntelliValidate's easy-to-use interface.

Advanced Validation Features

IntelliValidate has the ability to rotate images as needed to review / redact in the correct orientation, and then return the image to the previous orientation, as presented for validation with redaction zones intact and adjusted for the image rotation.

IntelliValidate allows review of images based on dynamic image quality values that range from 1 to 100, with 100 being the highest-quality documents. Users have the ability to specify combinations of system processing confidence values, in combination with image confidence values, to allow a validation operator to automatically focus on problematic images and trends within instrument types and recorded years.

IntelliValidate presents users with automatic highlights that consist of a complete set of ease-of-use visual affordances, to focus validators' attention where it is needed most, allowing the highest accuracy ratings to be achieved with the least amount of manual labor.

Intellidact provides the following user affordances to assist in accurate validation:

- **Redaction zone highlighting** for both the active (i.e. redaction candidate has focus) and non-active redaction zone candidates. The color and opacity of each type is user selectable within IntelliValidate's option settings.
- **Phrase highlighting** is user selectable and places a light blue box around keywords that were found during processing.
- **Dynamic Suggestion™ highlighting** places a purple box around additional text recommended for review / redact, pending other redactions on the existing image. Dynamic Suggestions show embedded, composite, or masquerading SSNs that cannot be located automatically by software, but are suggested by other items that have been marked or created for redaction during validation processing. For example, an SSN may be embedded within another number, composed of additional text/digits, mislabeled not with the standard SSN know-text keywords, or in worst possible cases contain no labels at all. Since all images that have redactions on them will be validated by CSI subject matter experts, IntelliValidate provides for automated technology to ensure that any embedded, composite or masquerading SSNs will not be missed due to human oversight.
- **RapidReview™ highlighting** places a red oval around text that has been specified by the validator and identified by the software as occurring on the image. The default setting is four numeric characters, but this can be easily set by the validation operator to be a static text pattern or regular expression, to help focus the validator's eye on the image area containing the specified data and of most interest.
- **QuickDraw™ highlighting** places a translucent mask over the logical word(s) currently selected to show the operator what data would be redacted if they were to left-mouse click on the QuickDraw highlighted fields.

IntelliValidate allows the full OCR converted text to be reviewed in a separate pop-up window and searched for user-specified patterns. Any found patterns produce additional highlights within the displayed text to allow for administrative analysis of image processing to occur in rapid fashion.

Image: 1994 Page: 1 - Reviewed -

IN THE COUNTY COURT IN AND FOR HILLSBOROUGH COUNTY, FLORIDA CIVIL DIVISION

CASE NO.: 04-12115-SC DIVISION NO: 1

THE INDEPENDENT SAVINGS PLAN COMPANY
d/b/a ISPC
6420 Benjamin Road
Tampa, FL 33634-5116
Plaintiff,

v.
PEGGY WADE
Defendant.

INSTR # 200-288668
BK 14067 PG 0440
Pg 0440: (1pg)
RECORDED 07/27/2004 09:52:18 AM
RICHARD AKE CLERK OF COURT
HILLSBOROUGH COUNTY
DEPUTY CLERK K Snider

FINAL JUDGMENT

THIS CAUSE came before the Court on July 7, 2004 for a Pre-Trial Conference at which a default against Defendant, PEGGY WADE, was entered, and it is hereupon

ORDERED AND ADJUDGED

That the Plaintiff, THE INDEPENDENT SAVINGS PLAN COMPANY d/b/a ISPC, recover from the Defendant, PEGGY WADE, the sum of \$4,384.24 in principal, the sum of \$177.48 in pre-judgment interest, the sum of \$169.00 in court costs, and the sum of \$500.00 in attorneys fees, making a total of \$5,230.72, that shall bear interest at the rate of 7% per year, for all of which let execution issue forthwith.

DONE AND ORDERED in Chambers at Hillsborough County, Florida this 19 day of July, 2004.

Judge Charlotte W. Anderson
Hillsborough County Court

cc: Michael D. Ginsberg, Esq.
Attorney for Plaintiff

Peggy Wade
373 SW 150th Loop
Ocala, FL 34473

SSN 555-4-2950

Social Security Number
55544-2950

DISP. REPORTED
SFS JUL 20 2004

Book 14067/Page 440
Book 3817/Page 1124 CFN# 2004131035

Page 1 of 1

Administrators | Im_idactdemo.intelidact_attrib

IntelliValidate showing all highlighting features

Assisted Validation

IntelliValidate's intelligent feature set allows a **single operator pass of images to achieve accuracy much higher than a manual two pass validation** effort, as it relies upon software technology rather than an extra set of eyes to catch redaction zones on documents.

IntelliValidate's "assisted" validation includes:

- **Stateful Inspection™** across all pages in a document or sets of documents, allowing validators to rapidly find and redact repeated information which otherwise might be missed.
- **Intellidact 3D™** provides an additional software pass after manual validation to ensure all changes made or accepted by a user are consistently applied across the entire document allowing us to achieve 99.95% accuracy.
- **TotalCase™** provides the ability for redactions that are dynamically made to a document to be remembered for the case (i.e. collection of documents having commonality identified in processing such as a prosecutor case number) and then automatically applied to all documents in the DMS/CMS existing for the case. In addition, this remembered dynamic redaction data is then also used to apply to all new documents belonging to the case as they enter the system. TotalCase is highly effective in minimizing manual labor and note taking on privacy protection work required in court document environments as information exists that is specific to a case and not easily processed as static data such as SSNs.

Accuracy

Despite what other vendors may claim about accuracy and their explanations of such, we would like to provide you with information on what differentiates Intellidact in being able to achieve such high accuracy on a consistent basis. Such is not impossible to achieve, does not involve funny calculations, and such does not require significant increases in manual review. Such requires ensuring that the manual review does not introduce human errors in the correction processes.

Typical redaction processing provided by vendors consists of two distinct stages or two processing dimensions in processing. The first step is automated software processing and the second step being some form of manual review or either all or some of the images being processed that the software has identified as requiring inspection. The process is depicted as follows:

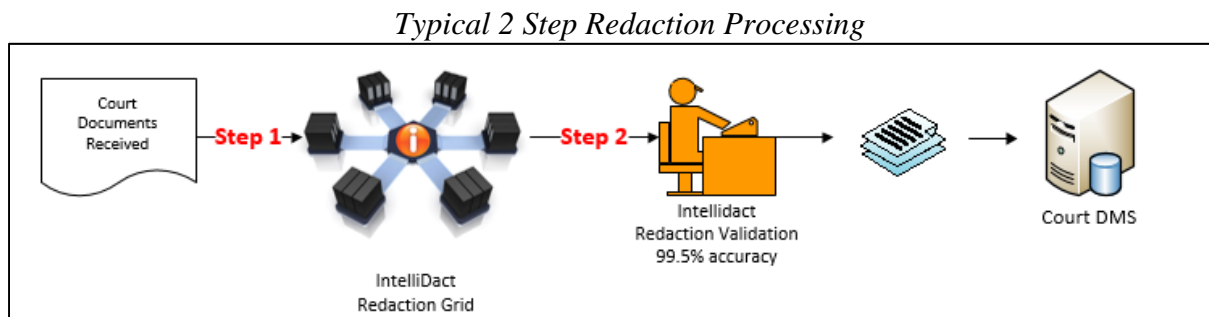

Through careful examination of work product in the processing of several billion images processed at 99.5% accuracy, CSI experts observed that the manual review process introduced slight errors in redacting of documents no matter how careful the operators were. Operators were not consistent with their redactions across all pages; items that were identified and manually redacted on one page of the document were not being redacted on secondary pages, etc...

To correct for this and provide the additional increase from 99.5% to 99.95% accuracy, CSI invented Intellidact 3D™ processing. That is, a third dimension in the redaction process and that being the application of an additional automated software pass after manual validation. The third automated pass corrects for user mistakes and enforces redaction consistency across the documents.

The process which allows Intellidact to routinely reach 99.95% accuracy in documents is depicted as follows.

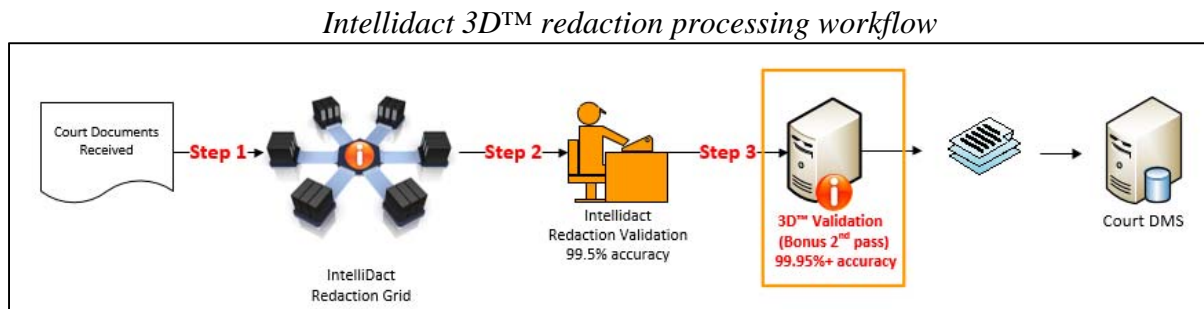

Future Proofing™

In 2007 the Supreme Court of Virginia published an RFP that called for the immediate redaction of SSNs, however expressed concern for five additional data types. In response to that RFP **CSI invented the concept of processing images once**, identifying all privacy data found, and burning only the subset of redactions allowed by current laws. The **additional privacy information data** (x, y, h, w coordinates, and the category of the data i.e. SSN, DL, DOB, etc.) from one time processing was **saved in condensed fashion** within Intellidact’s database (for future use).

This data was then made available for the Supreme Court to reuse without having to pay additional charges to **add or remove** redactions from their documents at any time of their documents lifecycle. This RFP was the **birth of technology** that today allows customers to **address future legislation additions**, and even local office policies on what information is redacted or “un-redacted” without customers having to pay for reprocessing of documents.

In addition to inventing the concept of processing once and saving what is not presently redacted, we also **introduced** the then unheard of **concept of automatically classifying redaction data** as to its type and not just providing its co-ordinates on an image. This required major changes in technology to allow for accurate identification, storage, and maintenance of data types, of course all occurring behind the scenes and from **CSI’s continuing research and development investments** to advance redaction technology.

Example IntelliValidate Screen Shot, including some Future Proof fields
 Note data tags appear above located privacy information

The screenshot shows a 'CIRCUIT WARRANT TO ARREST' form. A yellow box labeled 'Field Classification' has lines pointing to various data tags (NAME, DOB, SSN, AGENCY, etc.) scattered throughout the document. A yellow box labeled 'Signature Detection' has a line pointing to a signature at the bottom of the page.

CIRCUIT WARRANT TO ARREST
 FILED
 FELONY

STATE OF FLORIDA 2008 SEP 11 A 9:52
 VS. DAVID R. ELLSPERIAN, CLERK CIRCUIT COURT MARION COUNTY, FL
 IN THE CIRCUIT COURT OF THE FIFTH JUDICIAL CIRCUIT, MARION COUNTY, STATE OF FLORIDA

NAME: MARK ANTHONY SYDENSTRICKER
 AGENCY: 08-3800 CF-AZ (081960)

DOB: 08/11/1981 RACE: WHITE, SEX: MALE, SOCIAL: 348-72-0446, HEIGHT: 6'00", WEIGHT: 170, HAIR: BLACK, EYES: BLUE, ADDRESS: 1731 NE 30 ST OCALA, FL 34475, DRIVERS LICENSE NUMBER: S352-541-81-291-0

IN THE NAME OF THE STATE OF FLORIDA, TO ALL AND SINGULAR THE SHERIFFS OF FLORIDA, SPECIAL AGENTS OF THE FLORIDA DEPARTMENT OF LAW ENFORCEMENT AND FLORIDA STATE ATTORNEYS INVESTIGATORS;

HEREAS, DETECTIVE KEVIN BRINSON, has made before me that in the county and state aforesaid, MARK ANTHONY SYDENSTRICKER (W/M, DOB: 08/11/1981, SSN: 348-72-0446) in the County of Marion and the State of Florida, on or about the 21ST day of May, in the year of Our Lord, two thousand eight:

**COUNT I
 CREDIT CARD FRAUD (F3)
 817.61
 BOND AMOUNT \$2,000.00**

Did unlawfully and knowingly obtain money, goods or services, to-wit: US Currency, of a value of one hundred dollars (\$100.00) or more by fraudulent use of credit card or by unlawfully using a credit card three (3) or more times within a six (6) month period, to-wit: Visa debit card, number 4828536440011, issued to Anna Packer, without the consent of said cardholder, with the intent to defraud the said cardholder, the issuer, Wachovia Bank, or a person or organization providing the said money, goods or services, in violation of Florida Statute 817.61;

The offense(s) set forth in the forgoing warrant is/are contrary to the statute in such cases made and provided, and against the duty of the State of Florida, attached hereto and made a part hereof by incorporation is Affidavit executed by DETECTIVE KEVIN BRINSON, Affiant herein.

THESE ARE, THEREFORE, to command you to arrest said MARK ANTHONY SYDENSTRICKER and bring him before me to be dealt with according to law.

SIG: Rhonda K. Webster
 Affiant Personally Known to Notary Public

For the first several years, our concept was met with skepticism by other redaction vendors, and criticized in their RFP responses for not being accurate, taking more processing time, costing more in validation efforts, etc...however after losing many RFPs to CSI's novel **pay once for processing**, the **industry adopted Future Proofing™** and versions of it are offered under several different names by several different vendors.

Needless to say with CSI being the parent of the concept and **having several years lead** on other vendors we were **constantly making improvements** to keep on the leading edge of protecting our customer's investment with this functionality.

The screenshot displays the Intellidact Administrator web interface. The main navigation bar includes 'Welcome', 'Configuration', 'Advanced Options', 'Monitoring', and 'About'. The current page is 'Configuration >> Field Definitions'. On the left, there is a sidebar with 'Refresh' and 'Add new Field Definition' buttons. The central area contains a table of field definitions:

ID	Name
2	Social Security Number
3	Bank Account Number
4	Credit Card Number
5	Date of Birth
6	Maiden Name
7	Signature
8	Minor Name
9	Finger Print
10	Driver's License Number
100	Zip Code
101	Phone Number
102	e-mail Address

The 'Edit Field Definition' window is open for ID 2. It contains the following fields and options:

- Field Definition ID: 2
- Field Definition Name: Social Security Number
- Attribute Type: SSN
- Validation Type:
 - Current: Fields are automatically redacted and can be validated.
 - Current Elective: Fields are highlighted only. Validator must click to convert to redacted.
 - Future: Fields are automatically redacted, but hidden from Validator.
 - Future Elective: Fields are located, but not redacted.
 - Manual: Fields are not located. Validator must redact and classify fields manually.
 - None: Fields are not located, not redacted, and cannot be classified manually.
- Release:
 - No redactions
 - Burnt redactions
 - Encrypted redactions
 - XML included
- Advanced (Expert Mode)

Buttons at the bottom of the window are 'Delete', 'Update', and 'Cancel'.

Intellidact Web Administration Interface showing future proof field option settings

Technology / Features Unique to Intellidact

- 1) **Grid processing and redaction “job” architecture.** Intellidact’s compute grid provides for 24x7x365 high availability, fault tolerance with automatic recovery, automatic load balancing, and concurrent page processing for multi-page documents. Intellidact’s grid **scales linearly and provides enterprise lights out processing** important in large document volume environments. The grid’s concurrent page processing provides an additional benefit for the Clerk in processing time sensitive on demand redactions. With multi-page documents, having each page automatically directed to free CPU cores and processed concurrently, the total document processing time is reduced to that of a single page. All servers that participate in Intellidact grid processing are controlled from a centralized management console.

Intellidact Grid Enterprise Management Console

Server	Config ID	Process Type	Is Mgr	Priority	Active	Status	Process ID	OCR ID	Images Processed	Secs. Per Image	Alert Condition	Last Image Time	Instrument Code	Elapsed Time - D:HH:MM:SS
Configuration: Primary Test														
mccidact1 Management <input type="checkbox"/> 3 <input checked="" type="checkbox"/> OK Ping OK														
	3	BF Redactions			<input checked="" type="checkbox"/>	OK	3388	452	128	16.871	None	8.105	MTG	0:00:36:27
	4	BF Redactions			<input checked="" type="checkbox"/>	OK	3216	2584	136	15.799	None	19.545	MTG	0:00:36:25
	5	BF Redactions			<input checked="" type="checkbox"/>	OK	3488	3796	135	15.876	None	16.677	MTG	0:00:36:23
	6	BF Redactions			<input checked="" type="checkbox"/>	OK	3448	3516	126	17.014	None	17.550	MTG	0:00:36:21
mccidact2 Management <input type="checkbox"/> 2 <input checked="" type="checkbox"/> OK Ping OK														
	7	BF Redactions			<input checked="" type="checkbox"/>	OK	6246	4240	153	14.362	None	10.015	MTG	0:00:37:11
	8	BF Redactions			<input checked="" type="checkbox"/>	OK	5240	4164	151	13.960	None	20.614	MTG	0:00:35:32
	9	BF Redactions			<input checked="" type="checkbox"/>	OK	4196	4376	162	12.901	None	14.581	MTG	0:00:35:29
	10	BF Redactions			<input checked="" type="checkbox"/>	OK	3312	5936	159	13.126	None	16.550	MTG	0:00:35:27
mccidact3 Management <input checked="" type="checkbox"/> 1 <input checked="" type="checkbox"/> OK Ping OK														
	11	BF Redactions			<input checked="" type="checkbox"/>	OK	2564	5304	141	15.662	None	15.250	MTG	0:00:37:15
	12	BF Redactions			<input checked="" type="checkbox"/>	OK	984	5392	150	14.607	None	3.000	MTG	0:00:37:13
	13	BF Redactions			<input checked="" type="checkbox"/>	OK	6016	4540	153	14.362	None	10.015	MTG	0:00:37:11
	14	BF Redactions			<input checked="" type="checkbox"/>	OK	468	2120	146	14.974	None	21.999	MTG	0:00:37:09
pccsijpk Management <input type="checkbox"/> 4 <input checked="" type="checkbox"/> OK Ping OK														
	1	FF Redactions			<input checked="" type="checkbox"/>	OK	3016	3348	0	0.000	None	0.000		0:00:35:19
xxxxxx Management <input type="checkbox"/> 5 <input checked="" type="checkbox"/> No Response Ping Failed														
	15	BF Redactions			<input checked="" type="checkbox"/>	No Response	0	0	0	0.000	None	0.000		
Total Pages and Average Seconds:									1,602	15.117				

- 2) **Intellidact 3D™** redaction technology. Prior to Intellidact 3D, automated redaction processing was a two dimensional process. The first dimension was the application of automated software processing with the second dimension being manual review of software identified suspect documents. Manual review occurring as single, dual or multiple passes to validate that software as well as any prior validation operator had successfully performed their task. Intellidact 3D was invented to provide an extra dimension in processing by adding another pass of automated software review to all manually validated documents. Intellidact 3D processing locates and corrects user errors or inconsistencies and locates data not having context. Using 3D technology, Intellidact provides not less than 99.95% redaction accuracy.
- 3) **Intellidact Free Standing Name™** redaction technology. In the processing of court documents one of the more challenging aspects of redaction are names. It is not always possible to determine the relationship of a person’s name, and if their name should be the target of automated redaction. Intellidact’s Free Standing Name technology performs entity extraction and natural language processing to **automatically identify and highlight all names** contained within a document, allowing the user to rapidly focus their attention on names that are not able to

be automatically located and redacted based upon clear context (i.e. such as “The victim, John Smith” etc...). Intellidact Free Standing Name technology is also responsible for location of any nickname, abbreviation, or surname representations of a single name such as Elizabeth Montgomery, Liz Montgomery, Ms. Montgomery, etc...

Example of Intellidact Free Standing Name Technology with surname deviations

Collection: Image: 22291 Page: 1

Ms. Laura S. Laurence
Barris, Sott, Denn & Driker
211 West Fort Street
Fifteenth Floor
Detroit, MI 48226-3281

Re: Yvette Robinson vs Metropolitan Detroit Convention
& Vistors Bureau
Case No. 94-424247-NO

Dear Ms. Laurence:

This is the report of the psychiatric evaluation of Yvette Robinson conducted on June 14, 1995. The purpose of this examination was to determine whether, and to what extent, the patient suffered emotional injuries as a result of her termination of employment at Metropolitan Detroit Convention & Vistors Bureau (Detroit Convention). A mental status examination was conducted which is an observation of the patient's attitude and behavior toward the interview process, her stream, form and content of thought, her emotional reactions, her sensorium, mental grasp, insight and judgment.

Edward Czarnecki, Ph.D. performed psychological testing on Ms. Robinson which included a clinical interview, and the administering of the Minnesota Multiphasic Personality Inventory (MMPI-II) which is a personality test which provides independent objective data about the subject including attitude towards the

- 4) **Intellidact self-service updates.** CSI self-service update is an automated process for providing updates to Intellidact customers. Intellidact provides customers with the ability to query CSI, receive information on any and all available updates, easily download those of interest, and simply install them in test, quality control, or production processing environments. There is no need to train the system, no need to provide 10,000 documents of a specific type for CSI to write redaction rules on for you to obtain accurate processing results using Intellidact redaction technology. Out of the box unsurpassed accuracy and simple ways to maintain the technology.

Intellidact Web Administration User Interface Showing Customer Self Update Feature Set

The screenshot displays the Intellidact Administrator web interface. The top navigation bar includes 'Welcome', 'Configuration', 'Redaction', 'Indexing', 'Tasks', 'Reports', 'Monitoring', 'Advanced', and 'About'. The main content area is titled 'Configuration » Admin Options' and features a sidebar with menu items: 'Grid General', 'IntelliValidation', 'XML Configuration', 'Release Interface', 'Ascent Capture', 'NewVision Systems', and 'Updates'. The 'Updates' section shows the current update version as 4.0.1.0 - 01/01/1900. Details include 'Redaction Rules Version: (No redaction rules received yet)', 'Indexing Rules Version: (No indexing rules received yet)', and 'Last check for updates: Tue. 06/14/2011 12:27 PM'. The 'Current Projects' table lists various OCR projects with their versions and dates. The 'Updates' table shows a list of updates with columns for Version, Version Date, Date Received, Status, Date Installed, and By User. A red dashed box highlights the 'Check For Updates', 'Download', 'Install', 'Uninstall', 'History', and 'Information' buttons at the bottom of the interface.

OCR Project Name	Version	Version Date
Arrowhead.ipj	4.0.1.0	06/01/2011
citation_classify_pb.ipj	4.0.1.0	07/08/2010
citations_pb.ipj	4.0.1.0	04/15/2010
Intellidact2.ipj	4.0.1.0	05/12/2011
ORIndexing.ipj	4.0.1.0	06/07/2011
pb_courts.ipj	4.0.1.0	04/20/2010

Version	Version Date	Date Received	Status	Date Installed	By User
4.0.1.3	05/03/2011	(not downloaded)	New	(not installed)	CSIDEMO\demoadmin
4.0.1.2	05/02/2011	Tue. 06/14/2011 12:27 PM	Downloaded	(not installed)	CSIDEMO\demoadmin
4.0.1.0	01/01/1900	Tue. 06/14/2011 11:43 AM	Installed	Tue. 06/14/2011 11:43 AM	administrator

- 5) **Intellidact Eyesight™** is technology that performs topographical analysis of an image, allowing us to and classify images as to good or poor quality and to identify image artifacts that would cause problems in OCR processing and redactions to be missed. Eyesight, like other Intellidact software features, exist as “**software blades**” that are simply **inserted into Grid processing jobs** as the need arises to include their processing. For instance, Eyesight is useful if one was attempting to locate and redact document signatures, or to determine if images were of too poor a quality to be processed with just OCR technology.

EyeSight™ examples

Eyesight Cursive Script Detection

Eyesight Poor Quality Image Detection

12/28/2005 00:00:00 BOND BK 00321 0014 12/28/2005 8:21:14 AM

FIDUCIARYS BOND
Fiduciary Number F2005-0176228

KNOW ALL MEN BY THESE PRESENTS, THAT
Deborah S. Pawlak and Joseph J. Pawlak

The OBLIGOR(S) is/are (is/are) (is/are) firmly bound to the COMMONWEALTH OF VIRGINIA, in the sum of Seventy Five Thousand dollars to the payment whereof (we) bind myself/ourselves, our heirs, personal representatives, successors and assigns, jointly and severally, by these presents, hereby waiving the benefit of any homestead exemption as to this obligation.

This debt is without surety
Type of Surety: none

The Conditions of this BOND are:
Deborah S. Pawlak and Joseph J. Pawlak, the Obligor(s) was the city qualified as Co-Administrators of the estate of Daniel Joseph Pawlak deceased.

The Obligor(s) shall faithfully perform all duties required by law of said fiduciary office. If these conditions are faithfully fulfilled, this obligation shall be void; otherwise it shall remain in full force and effect.

In witness whereof, the Undersigned have hereunto set their hands and seals, this 28th day of December 2005.

Deborah S. Pawlak
Deborah S. Pawlak

Joseph J. Pawlak
Joseph J. Pawlak

Before the Clerk of the Fairfax County Circuit Court on this 28th day of December 2005.

The foregoing BOND was subscribed sworn to and acknowledged by:
Deborah S. Pawlak and Joseph J. Pawlak
The obligor(s) therein, and ordered to be recorded as provided by law.

Tested: John T. Pless Clerk

By: J. Zlotoff
Deputy Clerk

12/28/2005

Page: 11 - Reviewed -

EYESIGHT ALERT!

3/6/07
7/2/07
1/2/07
5/2/07
11/2/07
4/2/07
5/2/07
5/14/07

[Handwritten notes in cursive script, including medical and personal details, with dates and names.]

- 6) **Intellidact Obfuscation.** As the need to provide privacy protection continues to grow, so does the need to improve the readability of the documents containing redaction information. Intellidact includes the ability to obfuscate data rather than simply redact. Obfuscation is the replacement of text, for example the name John Smith, wherever it is encountered in a Court case is replaced with the text "victim-1", hiding the identity but preserving the context in reading.

Example of Intellidact Obfuscation replacing patient name with initials

Rosalind E. Griffin, M.D., P.C.	Exhibit 1
31330 Northwestern Highway Suite C Farmington Hills, Michigan 48334 [REDACTED] Fax: [REDACTED]	Psychiatry Adult & Adolescent
August 10, 1995	
<u>PSYCHIATRIC REPORT</u> <u>PERSONAL AND CONFIDENTIAL</u>	
Ms. Laura S. Laurence Barris, Sott, Denn & Driker 211 West Fort Street Fifteenth Floor Detroit, MI 48226-3281	
Re: [REDACTED] YR vs Metropolitan Detroit Convention & Vistors Bureau Case No. 94-424247-NO	
Dear [REDACTED]:	
This is the report of the psychiatric evaluation of [REDACTED] YR [REDACTED] YR conducted on June 14, 1995. The purpose of this examination was to determine whether, and to what extent, the patient suffered emotional injuries as a result of her termination of employment at Metropolitan Detroit Convention & Vistors Bureau (Detroit Convention). A mental status examination was conducted which is an observation of the patient's attitude and behavior toward the interview process, her stream, form and content of thought, her emotional reactions, her sensorium, mental grasp, insight and judgment.	
Edward Czarnecki, Ph.D. performed psychological testing on [REDACTED] YR	

- 7) **Highly accurate searchable PDF files.** As a byproduct of Intellidact the character recognition stage, Intellidact has the native ability to provide full text searchable PDF files, of the same image quality of the original TIFF, along with a highly accurate text layer (redacted or obfuscated as well). All done with rapid processing of the Intellidact compute Grid. Intellidact full text processing also enables our customer to provide full text searching across their entire repository rather than just single PDF files.
- 8) **Intellidact Document Management** includes enterprise workflow control for the entire processing phases, including the ability to set specific document types for validation, users within a specific county validate only their county's documents, which user get to process which documents, which documents have higher priority than others, which documents need to be validated within certain timeframes, how many validation passes are necessary until documents are considered to be complete, and of course, performance metrics of all workflow stages and user processing.

Intellidact Document Management - Enterprise Workflow Interface

The screenshot displays the Intellidact Document Management Enterprise Workflow Interface. On the left is a sidebar with a tree view of document categories such as 'Active Documents', 'Error Documents', 'Verification', 'Processing', 'State', 'Not Available', 'Completed', 'Chests', 'Documents by Type', 'Accord/WCA', 'Circuit Civil', 'Circuit Criminal', 'Citation case initiation', 'Citation Initiation', 'County Civil', 'County Criminal', 'CVBatch', 'CVBatchSmall', 'CVMultiDoc', 'Family Docketing', 'Juvenile Delinquency', 'Juvenile Dependency', 'Not Provided', 'DCR Only', 'DR Assignment', 'DR Certificate of title', 'DR Judgment', 'DR marriage license', 'DR Satisfaction', 'Probate', 'POV Redact', 'Traffic Docketing', 'Document Queues', 'Security', 'Groups', and 'Users'. The main area shows a table of document processing records with columns for Document ID, Name, Creation, Last Action, State, Service, Queue, Priority, Location, and Assigned To. The table contains 30 rows of data, showing various document IDs (e.g., 953, 954, 955) and their corresponding processing details.

Document ID	Name	Creation	Last Action	State	Service	Queue	Priority	Location	Assigned To
953	248 CV 11/2/2011 3:57:54 PM - CVBatch	11/02/2011 03:59:20 PM	11/04/2011 10:32:32 AM	Ready	Both	(2) Redaction	10		
954	248 CV 11/2/2011 3:57:54 PM - CVBatch (03:58:24.107)	11/02/2011 03:59:28 PM	11/04/2011 10:32:32 AM	Ready	Both	(1) Indexing	10		
955	247 CV 11/2/2011 3:57:48 PM - CVBatch	11/02/2011 03:59:49 PM		Ready	Both	(1) Indexing	10		
956	248 CV 11/2/2011 3:57:54 PM - CVBatch (03:58:24.625)	11/02/2011 03:59:54 PM	11/03/2011 09:03:42 AM	Suspended	Both	(1) Indexing	10		
957	248 CV 11/2/2011 3:57:54 PM - CVBatch (03:58:25.517)	11/02/2011 04:00:10 PM		Ready	Both	(1) Indexing	10		probate_lead
958	248 CV 11/2/2011 3:57:54 PM - CVBatch (03:58:25.811)	11/02/2011 04:00:19 PM		Ready	Both	(1) Indexing	10		probate_lead
959	247 CV 11/2/2011 3:57:48 PM - CVBatch (03:59:03.673)	11/02/2011 04:00:29 PM		Ready	Both	(1) Indexing	10		
960	247 CV 11/2/2011 3:57:48 PM - CVBatch (03:59:04.642)	11/02/2011 04:00:35 PM		Ready	Both	(1) Indexing	10		
961	247 CV 11/2/2011 3:57:48 PM - CVBatch (03:59:05.066)	11/02/2011 04:00:48 PM	11/04/2011 12:29:55 PM	Ready	Both	(3) Indexing/Redaction	3		
962	247 CV 11/2/2011 3:57:48 PM - CVBatch (03:59:05.662)	11/02/2011 04:00:57 PM		Ready	Both	(1) Indexing	10		
963	247 CV 11/2/2011 3:57:48 PM - CVBatch (03:59:05.943)	11/02/2011 04:01:25 PM	11/03/2011 04:37:24 PM	Ready	Both	(2) Redaction	10		
964	247 CV 11/2/2011 3:57:48 PM - CVBatch (03:59:06.952)	11/02/2011 04:01:45 PM		Ready	Both	(1) Indexing	10		
965	247 CV 11/2/2011 3:57:48 PM - CVBatch (03:59:06.893)	11/02/2011 04:02:01 PM		Ready	Both	(1) Indexing	10		
966	247 CV 11/2/2011 3:57:48 PM - CVBatch (03:59:07.396)	11/02/2011 04:02:15 PM		Ready	Both	(1) Indexing	10		
968	247 CV 11/2/2011 3:57:48 PM - CVBatch (03:59:08.018)	11/02/2011 04:02:44 PM		Ready	Both	(1) Indexing	10		
969	247 CV 11/2/2011 3:57:48 PM - CVBatch (03:59:08.629)	11/02/2011 04:03:24 PM		Ready	Both	(1) Indexing	10		
970	247 CV 11/2/2011 3:57:48 PM - CVBatch (03:59:08.955)	11/02/2011 04:03:33 PM		Ready	Both	(1) Indexing	10		
972	247 CV 11/2/2011 3:57:48 PM - CVBatch (03:59:09.666)	11/02/2011 04:04:09 PM	11/04/2011 03:12:43 PM	Ready	Both	(3) Indexing/Redaction	5		
973	247 CV 11/2/2011 3:57:48 PM - CVBatch (03:59:09.950)	11/02/2011 04:04:13 PM	11/04/2011 03:13:01 PM	Ready	Both	(3) Indexing/Redaction	5		
975	247 CV 11/2/2011 3:57:48 PM - CVBatch (03:59:10.464)	11/02/2011 04:04:34 PM	11/04/2011 12:29:50 PM	Ready	Both	(3) Indexing/Redaction	5		
976	247 CV 11/2/2011 3:57:48 PM - CVBatch (03:59:10.737)	11/02/2011 04:04:49 PM		Ready	Both	(1) Indexing	10		
978	247 CV 11/2/2011 3:57:48 PM - CVBatch (03:59:11.246)	11/02/2011 04:05:11 PM	11/04/2011 10:32:27 AM	Ready	Both	(3) Indexing/Redaction	5		
979	247 CV 11/2/2011 3:57:48 PM - CVBatch (03:59:11.601)	11/02/2011 04:05:45 PM	11/04/2011 10:32:27 AM	Ready	Both	(3) Indexing/Redaction	5		
980	247 CV 11/2/2011 3:57:48 PM - CVBatch (03:59:11.976)	11/02/2011 04:05:49 PM	11/08/2011 01:48:16 PM	Ready	Both	(3) Indexing/Redaction	5		
981	247 CV 11/2/2011 3:57:48 PM - CVBatch (03:59:12.119)	11/02/2011 04:06:02 PM	11/04/2011 10:32:29 AM	Ready	Both	(2) Redaction	5		
982	247 CV 11/2/2011 3:57:48 PM - CVBatch (03:59:12.364)	11/02/2011 04:06:07 PM	11/04/2011 10:32:29 AM	Ready	Both	(2) Redaction	5		
983	247 CV 11/2/2011 3:57:48 PM - CVBatch (03:59:12.677)	11/02/2011 04:06:19 PM	11/04/2011 10:32:29 AM	Ready	Both	(1) Indexing	5		
984	247 CV 11/2/2011 3:57:48 PM - CVBatch (03:59:12.988)	11/02/2011 04:06:24 PM	11/04/2011 10:32:30 AM	Ready	Both	(1) Indexing	5		
985	247 CV 11/2/2011 3:57:48 PM - CVBatch (03:59:13.186)	11/02/2011 04:06:37 PM	11/04/2011 10:32:30 AM	Ready	Both	(1) Indexing	5		
986	247 CV 11/2/2011 3:57:48 PM - CVBatch (03:59:13.496)	11/02/2011 04:06:40 PM	11/04/2011 10:32:30 AM	Ready	Both	(1) Indexing	5		
987	247 CV 11/2/2011 3:57:48 PM - CVBatch (03:59:13.761)	11/02/2011 04:06:54 PM	11/03/2011 04:21:07 PM	Suspended	Both	(2) Redaction	5		
988	247 CV 11/2/2011 3:57:48 PM - CVBatch (03:59:14.012)	11/02/2011 04:06:58 PM	11/04/2011 12:16:45 PM	Ready	Both	(2) Redaction	5		
989	247 CV 11/2/2011 3:57:48 PM - CVBatch (03:59:14.267)	11/02/2011 04:07:10 PM	11/04/2011 10:32:31 AM	Ready	Both	(2) Redaction	5		
990	247 CV 11/2/2011 3:57:48 PM - CVBatch (03:59:14.631)	11/02/2011 04:07:15 PM	11/04/2011 10:32:32 AM	Ready	Both	(2) Redaction	5		
991	247 CV 11/2/2011 3:57:48 PM - CVBatch (03:59:14.898)	11/02/2011 04:07:27 PM		Ready	Both	(1) Indexing	10		
992	247 CV 11/2/2011 3:57:48 PM - CVBatch (03:59:15.237)	11/02/2011 04:07:32 PM		Ready	Both	(1) Indexing	10		
993	247 CV 11/2/2011 3:57:48 PM - CVBatch (03:59:15.561)	11/02/2011 04:07:44 PM		Ready	Both	(1) Indexing	10		
994	247 CV 11/2/2011 3:57:48 PM - CVBatch (03:59:15.863)	11/02/2011 04:07:45 PM		Ready	Both	(1) Indexing	10		
995	247 CV 11/2/2011 3:57:48 PM - CVBatch (03:59:16.144)	11/02/2011 04:08:01 PM		Ready	Both	(1) Indexing	10		
996	247 CV 11/2/2011 3:57:48 PM - CVBatch (03:59:16.487)	11/02/2011 04:08:06 PM		Ready	Both	(1) Indexing	10		

- 9) Available only from CSI (and patent pending) is **Intellidact Total Case™** redaction technology. Such was invented by CSI to address the dynamic nature of court document information privacy. Simply stated, Total Case redaction allows user selected redactions to be automatically applied (or removed) from **all documents within a court case at any point in a case's lifetime**. By all documents we mean not only the one which is currently being processed, but those that have already been processed and are located within your document management system, as well as those that have yet to be e-filed or scanned onto the case.

Total Case Redaction Field Specification

The screenshot displays a legal document interface with a redaction menu and a properties window. The redaction menu, located on the left, lists various fields for redaction, with 'Patient Name' and 'Collection' highlighted. The 'Patient Name' field is further specified with 'Yvette Robinson' and 'Maiden Name'. The 'Collection' field is specified with 'Name: 2006CA001352' and 'Description: Collection for case: 2006CA001352'. The properties window on the right shows document details such as 'Processed ID: 19268', 'Image ID: 20943', and 'Document ID: 5011'. A red dashed box highlights the 'Patient Name' and 'Collection' fields in the redaction menu, and a red arrow points from this box to a text box at the bottom right.

An example of case specific redaction, a name (patient, victim, or otherwise) being identified by a user performing validation and the system being instructed to apply it to all documents for the case, whether the documents are pre-existing (i.e. already scanned and stored), or for documents submitted in the future for the case.

Copyright © 2011, CSI. All Rights Reserved.

Redaction Examples.

Example 1 Note Stamp interfering with SSN but Intellidact successful redaction

1040 U.S. Individual Income Tax Return 2003

All other tax returns are in respondent's possession

Label: PEGGY L CONNOLLY, 507-80-8446

Address: 4416 Park Lake Terrace So., Bradenton, FL 34209

Exemptions: 6a Yourself, if your parent (or other tax return, do not check this box) can claim you as a dependent on his or her tax return, do not check this box. Spouse. Dependent: CAITLIN F. CONNOLLY, Daughter; KELLEN P. CONNOLLY, Son.

Income: 7 Wages, salaries, tips, etc. 57,396; 8a Taxable interest 74; 9a Ordinary dividends 47; 12 Business income (or loss) -1,382; 22 Total income 56,622.

Adjusted Gross Income: 23 Educator expenses 24; 24 IRA deduction 25; 25 Student loan interest deduction 26; 26 Tuition and fees deduction 27; 27 Moving expenses 28; 28 One-half of self-employment tax 29; 29 Self-employed health insurance deduction 30; 30 Self-employed SEP, SIMPLE, and qualified plans 31; 31 Penalty on early withdrawal of savings 32; 32 Alimony paid 33; 33 Add lines 23 through 32 35; 34 Subtotal line 33 from line 22. This is your adjusted gross income 34 56,587.

Before

1040 U.S. Individual Income Tax Return 2003

All other tax returns are in respondent's possession

Label: PEGGY L CONNOLLY, 507-80-8446

Address: 4416 Park Lake Terrace So., Bradenton, FL 34209

Exemptions: 6a Yourself, if your parent (or other tax return, do not check this box) can claim you as a dependent on his or her tax return, do not check this box. Spouse. Dependent: CAITLIN F. CONNOLLY, Daughter; KELLEN P. CONNOLLY, Son.

Income: 7 Wages, salaries, tips, etc. 57,396; 8a Taxable interest 74; 9a Ordinary dividends 47; 12 Business income (or loss) -1,382; 22 Total income 56,622.

Adjusted Gross Income: 23 Educator expenses 24; 24 IRA deduction 25; 25 Student loan interest deduction 26; 26 Tuition and fees deduction 27; 27 Moving expenses 28; 28 One-half of self-employment tax 29; 29 Self-employed health insurance deduction 30; 30 Self-employed SEP, SIMPLE, and qualified plans 31; 31 Penalty on early withdrawal of savings 32; 32 Alimony paid 33; 33 Add lines 23 through 32 35; 34 Subtotal line 33 from line 22. This is your adjusted gross income 34 56,587.

After

Example 2
Note first 5 digits of SSN redaction as well as signatures.
SSN appears with improper or no keywords and with zeros appended to number.
Date of birth Future Proofed™ and not burnt on released image

JD 04-366

NELSON E GALYEAN
55570879400

MEMORANDUM OF LIEN
COMMONWEALTH OF VIRGINIA

Department of Taxation
P.O. Box 1880
Richmond, Virginia 23218-1880

As provided by Section 58.1-1805 of the Code of Virginia, notice is given that taxes (including interest and penalties) have been assessed against the following named taxpayer. Demand for payment of this liability has been made, but it remains unpaid. Therefore, the Tax Commissioner has caused this Memorandum of Lien to be filed in the Clerk's Office of the Circuit Court and recorded in the Judgment Docket Book. This Memorandum shall have the same effect as a judgment in favor of the Commonwealth.

For Optional Use by Clerk's Office

Location of Circuit Court
CHARLES T. STURGILL, CLERK
GRAYSON CIRCUIT COURT
129 DAVIS STREET
INDEPENDENCE, VA 24348

Case Number
55570879400
FEIN/SSN:
555-708794
SSN 2:

Name of Taxpayer and Last Known Mailing Address
NELSON E GALYEAN
1681 CROSSROADS DRIVE
GALAX, VA 24333-3792

City/County of Residence or Principal Place of Business
Name of City/County: Grayson

Date of Birth
July 31, 1947

Department of Taxation
Issuing Office
Office of Compliance
District Office - Bristol
P. O. Box 5540
BRISTOL, VA 24203-5540
(423) 968-2875

Date: August 13, 2004

By: *Jackie J. McDavid*
Jackie J. McDavid

Type of Tax	Tax Period	Date of Assessment	Assessment Number	Judgment Amount
Employer Withholding	02/01/02 - 11/30/02	01/13/04	19147	\$916.73
Sales	02/01/02 - 10/31/02	01/13/04	19148	\$7,662.11
TOTAL				\$8,578.84

VIRGINIA
IN THE CLERK'S OFFICE OF
GRAYSON
AUGUST 17, 2004 AT 09:12AM
JUDGMENT/RELEASE #040000366 WAS DOCKETED
UPON CERTIFICATION OF ACKNOWLEDGEMENT
THERE TO ANNEXED, ADMITTED TO RECORD,
THE FEE IMPOSED BY SEC. 17.1-275(17)
OF THE VIRGINIA CODE, HAS BEEN PAID.
RPT: 040000494 BK: PG:-----
TESTE: CHARLES T. STURGILL, CLERK
BY: *Susan A. Harrison* D.C.

Before

JD 04-366

NELSON E GALYEAN
55579400

MEMORANDUM OF LIEN
COMMONWEALTH OF VIRGINIA

Department of Taxation
P.O. Box 1880
Richmond, Virginia 23218-1880

As provided by Section 58.1-1805 of the Code of Virginia, notice is given that taxes (including interest and penalties) have been assessed against the following named taxpayer. Demand for payment of this liability has been made, but it remains unpaid. Therefore, the Tax Commissioner has caused this Memorandum of Lien to be filed in the Clerk's Office of the Circuit Court and recorded in the Judgment Docket Book. This Memorandum shall have the same effect as a judgment in favor of the Commonwealth.

For Optional Use by Clerk's Office

Location of Circuit Court
CHARLES T. STURGILL, CLERK
GRAYSON CIRCUIT COURT
129 DAVIS STREET
INDEPENDENCE, VA 24348

Case Number
55579400
FEIN/SSN:
555-794
SSN 2:

Name of Taxpayer and Last Known Mailing Address
NELSON E GALYEAN
1681 CROSSROADS DRIVE
GALAX, VA 24333-3792

City/County of Residence or Principal Place of Business
Name of City/County: Grayson

Date of Birth
July 31, 1947

Department of Taxation
Issuing Office
Office of Compliance
District Office - Bristol
P. O. Box 5540
BRISTOL, VA 24203-5540
(423) 968-2875

Date: August 13, 2004

By: [Redacted]
Jackie J. McDavid

Type of Tax	Tax Period	Date of Assessment	Assessment Number	Judgment Amount
Employer Withholding	02/01/02 - 11/30/02	01/13/04	19147	\$916.73
Sales	02/01/02 - 10/31/02	01/13/04	19148	\$7,662.11
TOTAL				\$8,578.84

VIRGINIA
IN THE CLERK'S OFFICE OF
GRAYSON
AUGUST 17, 2004 AT 09:12AM
JUDGMENT/RELEASE #040000366 WAS DOCKETED
UPON CERTIFICATION OF ACKNOWLEDGEMENT
THERE TO ANNEXED, ADMITTED TO RECORD,
THE FEE IMPOSED BY SEC. 17.1-275(17)
OF THE VIRGINIA CODE, HAS BEEN PAID.
RPT: 040000494 BK: PG:-----
TESTE: CHARLES T. STURGILL, CLERK
BY: [Redacted] D.C.

After

Example 3 – Handprint

Note perfect automatic redaction mask sizes for handprint in the redacted after image. The DOB once again being located and not burnt on output image (Future Proof™).

Note also on the before image the text in yellow box of Social Security Number 555414762 is ICR results from Recostar handprint engine even though the 414762 is poor and has line damage (Trigram analysis with line removal and character repair ICR technology)

THE CIRCUIT COURT OF THE TWELFTH JUDICIAL CIRCUIT
IN AND FOR MANATEE COUNTY, FLORIDA

Memorandum to Clerk

STYLE OF CASE: Rhonda M. Easterling vs. Rickey Phillipson Aka
CASE NUMBER: 2004 08 273 JV
PETITIONER RESPONDENT IS/ARE VICTIMS OF DOMESTIC VIOLENCE RickeyWayne Phillipson

PAYOR INFORMATION

1. NAME: Rickey Phillipson Aka RickeyWayne Phillipson
RESIDENTIAL ADDRESS: 823 Wintergarden Dr.
Sarasota, Fl 34243
MAILING ADDRESS: 823 Wintergarden Dr.
Sarasota, Fl 34243
DOB: 9/27/1975 SOCIAL SECURITY NO. 555 41 3787
RACE: W SEX: M HGT: 6.00 WT: EYES: Br HAIR: BK
EMPLOYER: Westra Construction
ADDRESS: P.O. Box 1149
Palmetto, Fl 34220

3. ATTORNEY FOR PAYOR:

PAYEE INFORMATION

1. NAME: Rhonda M. Easterling
MAILING ADDRESS: 910 Smith Co Department of Human Services
P.O. Box 100, Raleigh, Mississippi 39153
SOCIAL SECURITY NO.: 555 41 4762
CHILD
Nathan Easterling Social Security Number 555 414762
10/11/1999 555 87 5997

2. ADDITIONAL INFORMATION:

Before

THE CIRCUIT COURT OF THE TWELFTH JUDICIAL CIRCUIT
IN AND FOR MANATEE COUNTY, FLORIDA

Memorandum to Clerk

STYLE OF CASE: Rhonda M. Easterling vs. Rickey Phillipson Aka
CASE NUMBER: 2004 08 273 JV
PETITIONER RESPONDENT IS/ARE VICTIMS OF DOMESTIC VIOLENCE RickeyWayne Phillipson

PAYOR INFORMATION

1. NAME: Rickey Phillipson Aka RickeyWayne Phillipson
RESIDENTIAL ADDRESS: 823 Wintergarden Dr.
Sarasota, Fl 34243
MAILING ADDRESS: 823 Wintergarden Dr.
Sarasota, Fl 34243
DOB: 9/27/1975 SOCIAL SECURITY NO. 3787
RACE: W SEX: M HGT: 6.00 WT: EYES: Br HAIR: BK
EMPLOYER: Westra Construction
ADDRESS: P.O. Box 1149
Palmetto, Fl 34220

3. ATTORNEY FOR PAYOR:

PAYEE INFORMATION

1. NAME: Rhonda M. Easterling
MAILING ADDRESS: 910 Smith Co Department of Human Services
P.O. Box 100, Raleigh, Mississippi 39153
SOCIAL SECURITY NO.: 4762
CHILD
Nathan Easterling 10/11/1999 SOCIAL SECURITY NO. 5997

2. ADDITIONAL INFORMATION:

After

Document Management System Integration

Intellidact provides integrations with leading DMS and land records systems to protect your investments in Intellidact redaction processing technology and services

What method you use will be determined by the level of integration that you desire to maintain. Also as an enterprise solution and not a specific DMS/CMS solution, we provide universal web services that may be used to submit and retrieve documents as well. This would allow Intellidact to be integrated within any application, workflow, or document management system in use by AOC or individual Arkansas counties.

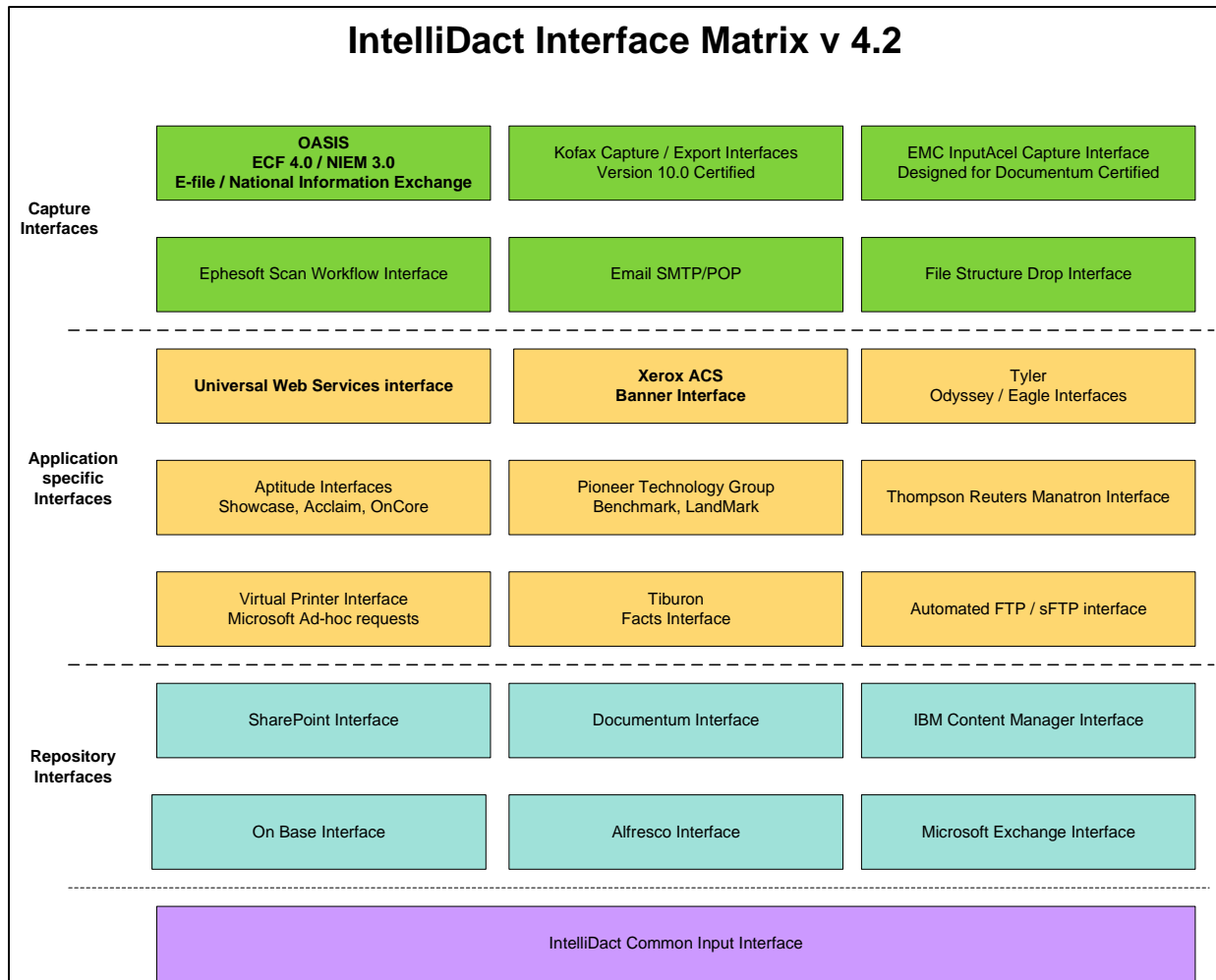

Configuration, Reports, Code, Rule, Control Tables

Describe the process for configuring your solution for implementation in a multi-jurisdictional court system. Provide a list and copies of all predefined reports, code, rule, and control tables. Include any mechanisms available for versioning codes (such as begin/end dates).

Configuration

Intellidact ships ready to run redaction for a multiple-jurisdictional court, or for that matter any enterprise, out of the box. Configuration of what data items are to be redacted is via a web interface, and is administered by CSI staff upon client completion of their redaction check list.

If multiple input sources are to be processed with in Intellidact, or multiple document output is to occur, CSI staff either performs or assists clients in configuring the processing jobs and redaction security profiles (“RSP’s”) via the web interface as well.

There are no begin and end dates for configuration settings to be applicable, there are however different processing options provided for with Intellidact’s extensible software blade architecture.

Reporting

Intellidact provides for historical reporting as well as real time reporting. Reporting is available from within the Intellidact Management User Interface (MUI) or the Web Administration interface. Intellidact utilizes Crystal Reports and HTML rendered pages for real time reporting on processing activities. Currently Intellidact ships out of the box with twenty six standard reports (12 that relate to redaction) that audit everything from processing speed per image to manual validation operator accuracy on a field level. Customers have the ability to create their own reports or customize the existing ones. Our professional services are also available to create or modify any reports should the customer not have staff that can perform such modifications.

Several examples of Intellidact reporting follow.

Additional reports provide:

- Backfile processing and validation occurring at CSI’s facility:
 - Delivery Listing - batch detail by document ID, page number, redacted field
 - Progress Listing - batches received (docs/pages count), batches returned (docs/pages count, # redactions by doc/image/field)
- Validator Productivity
 - Validation pending queue
 - Validation summary
 - Validation detail - by validator, timestamp of review, redaction changes
- Accuracy
 - Redaction accuracy by field
 - Redaction accuracy by image
- Throughput
 - Processing output calendar
 - Processing status by field
 - Processing status by document type



Validation Activity - Detail

W1.intellidact_osceola_or_certrun

All Users

All dates before and including April 15, 2009

User ID	Instrument	Book / Page	Reviewed	Sent to Admin	QC Reason	Redaction			Trivial	
						Create	Modify	Delete	Modify	
akaiser	88005210	867 / 1205	Yes	No	S Unknown	1	0	0	0	
	88012123	871 / 971	Yes	No	U None	1	0	0	0	
	90057710	985 / 1273	Yes	No	S Unknown	1	0	0	0	
	91008619	1003 / 1772	Yes	No	U None	1	0	0	0	
	91031218	1016 / 2263	Yes	No	U None	1	0	0	0	
	94080862	1213 / 910	Yes	No	U Long number found - not redacted	2	0	0	0	
	94080862	1213 / 912	Yes	No	U Long number found - not redacted	3	0	0	0	
	96004317	1303 / 69	Yes	No	U None	1	0	0	0	
	97040149	1397 / 286	Yes	No	S Unknown	1	0	0	0	
	99106517	1634 / 1491	Yes	No	U Long number found - not redacted	1	0	0	0	
	2002122900	2082 / 328	Yes	No	U Long number found - not redacted	3	0	0	0	
	2005148000	2825 / 380	Yes	No	U Long number found - not redacted	1	0	0	0	
	2006185894	3223 / 2921	Yes	No	S Unknown	1	0	0	0	
	2006294977	3358 / 2931	Yes	No	U Long number found - not redacted	1	0	0	0	
	2007174662	3567 / 345	Yes	No	S Unknown	1	0	0	0	
	mstanley	91011279	1005 / 391	Yes	No	S Bank acct/credit card - redacted	0	1	0	0
		92095988	1102 / 2818	Yes	No	U None	0	0	0	1
92095988		1102 / 2819	Yes	No	U None	0	1	0	0	
94080862		1213 / 908	Yes	No	S Bank acct/credit card - redacted	0	0	1	0	
94084258		1215 / 811	Yes	No	U None	0	0	1	0	
95006937		1235 / 2264	Yes	No	U None	0	0	0	1	
96069543		1346 / 670	Yes	No	U None	0	1	0	0	
97119479		1451 / 649	Yes	No	U None	0	2	0	0	
2001086280		1892 / 419	Yes	No	U None	0	0	0	2	
2005011567		2678 / 1931	Yes	No	U None	0	0	1	0	
2005050615		2715 / 2331	Yes	No	U None	0	0	0	1	
2005208600		2903 / 2145	Yes	No	S Bank acct/credit card - redacted	0	0	1	0	
2006100886		3127 / 1264	Yes	No	S Advanced recognition engine	0	0	2	0	
2007090201		3476 / 2572	Yes	No	S Bank acct/credit card - redacted	1	0	0	0	
2007090201		3476 / 2574	Yes	No	U Long number found - not redacted	0	0	1	0	
mworkman	86019918	805 / 747	Yes	No	M Required field not found	1	0	0	0	
	86041026	817 / 1297	Yes	No	U Long number found - not redacted	1	0	0	0	
	86053122	824 / 1689	Yes	No	M Required field not found	1	0	0	0	
	87033556	846 / 486	Yes	No	M Required field not found	1	0	0	0	
	87049776	855 / 1766	Yes	No	M Required field not found	1	0	0	0	
	87064057	864 / 47	Yes	No	M Required field not found	1	0	0	0	
	88005210	867 / 1204	Yes	No	M Required field not found	1	0	0	0	
	88050035	894 / 883	Yes	No	M Required field not found	1	0	0	0	
	88050760	894 / 2253	Yes	No	M Required field not found	1	0	0	0	
	89076351	950 / 353	Yes	No	M Required field not found	1	0	0	0	
	90031552	970 / 1174	Yes	No	M Required field not found	1	0	0	0	
	90055165	984 / 119	Yes	No	M Required field not found	1	0	0	0	
	90060887	987 / 404	Yes	No	M Required field not found	1	0	0	0	
	90081325	998 / 2768	Yes	No	U Bank acct/credit card - not redacted	2	0	0	0	
	91040079	1022 / 670	Yes	No	M Required field not found	1	0	0	0	
	91045527	1025 / 1176	Yes	No	M Required field not found	1	0	0	0	
	91057017	1032 / 1806	Yes	No	M Required field not found	1	0	0	0	
	92006042	1049 / 2653	Yes	No	M Required field not found	1	0	0	0	

Generated on 4/15/2009 at 5:33:25PM

W1.intellidact_osceola_or_certrun Page 1 of 5



Redacted Images - Summary

W1.intellidact_osceola_or

All Users

September 15, 2008 to September 17, 2008

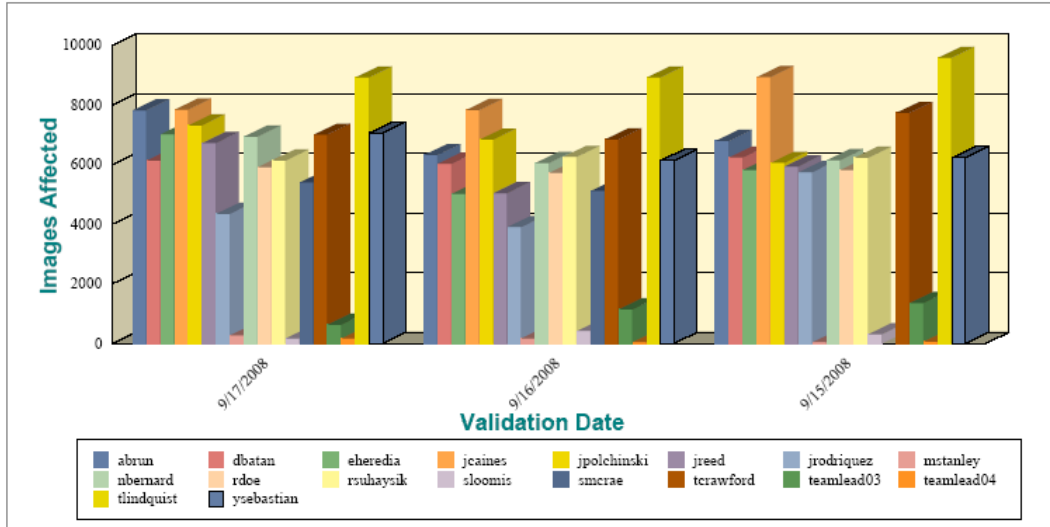

	Images				Redaction Fields								
	Affected	Reviewed	Altered	%Changed	Created	Modified	Deleted	Minor Chg					
Wednesday, September 17, 2008													
abrun	7,819	7,819	1,678	21.46%	682	71	889	292					
	7am	8am	9am	10am	11am	12pm	1pm	2pm	3pm	4pm	5pm	6pm	7pm
	0	0	549	970	1215	1273	1056	842	918	890	106	0	0
dbatan	6,136	6,136	1,074	17.50%	532	17	792	13					
	7am	8am	9am	10am	11am	12pm	1pm	2pm	3pm	4pm	5pm	6pm	7pm
	0	0	846	789	725	811	518	825	663	822	137	0	0
eheredia	7,016	7,016	1,190	16.96%	551	93	716	48					
	7am	8am	9am	10am	11am	12pm	1pm	2pm	3pm	4pm	5pm	6pm	7pm
	0	0	818	818	803	1021	455	1413	1030	538	120	0	0
jcaines	7,841	7,834	1,538	19.61%	727	47	1,007	64					
	7am	8am	9am	10am	11am	12pm	1pm	2pm	3pm	4pm	5pm	6pm	7pm
	0	12	890	849	1205	1043	1154	753	986	787	162	0	0
jpolchinski	7,317	7,306	1,260	17.22%	526	32	955	10					
	7am	8am	9am	10am	11am	12pm	1pm	2pm	3pm	4pm	5pm	6pm	7pm
	0	0	280	1166	927	1297	386	1165	786	908	402	0	0

Generated on 4/15/2009 at 7:14:37PM

W1.intellidact_osceola_or Page 1 of 7

File Formats, Multi-media Support, and Security

List the file formats supported for redaction by the system.

Input:

- TIFF – bi-tonal, Group IV compression
- PDF
- PDF/A
- PDF Searchable, over bitmap image
- PDF/A Searchable, over bitmap image
- MS-Word
- JPEG
- GIF
- XML
- Text

Output:

- TIFF – bi-tonal, Group IV compression
- PDF
- PDF/A
- PDF Searchable, over bitmap image
- PDF/A Searchable, over bitmap image
- XML
- Text

List and Description of Services

Provide a list and description of services available should the court wish to deliver a repository of images for redaction.

Redaction Processing at CSI

AOC can also elect to perform its redaction processing utilizing CSI's private redaction cloud making no investment in processing infrastructure. We currently provide such for the state of Iowa and several large California counties.

CSI is presently engaged in various planning, implementation, and sophisticated image processing projects for various organizations with **735M back-filed images** and **410M forward file images** being **processed this past year** alone. In order to **maintain absolute quality control** over processing customer images, **CSI maintains its own secure data center** at its 10,000 square foot headquarters located in Central Florida. The current hardware environment has the **capacity to process in excess of 20 million images per week**.

CSI's data center maintains two distinct 100Mb fiber optic internet connections protected by a 2 node Check Point UTM cluster, Check Point DLP appliance, Riverbed WAN acceleration cluster, and Forescout Active Scout intrusion prevention to provide secure 24x7x365 access to CSI resources. State of the art internet connectivity and state of the art network security provide our customers with absolute security of their image processing.

CSI's data center employs primary processing resources of **four Dell M1000E blade chassis** (16 blades each), and 15 Dell 2950's X5460 Quad core servers to provide **888 physical CPU cores** for the Intellidact compute grid. The current data center configuration has approximately **2,220 GHZ** of usable CPU and **6,144GB of ram** running VMware Virtual Infrastructure 5 to provide **multiple fault tolerant** VMware clusters with high availability, automatic load balancing, and customer isolation for all processing.

Data storage is provided by a **45TB** EMC fiber channel storage array with dual HA brocade silkworm 3800 switches and a **96TB** Equal logic ISCSI storage array operating with dual 10GB Cisco 4900M switches. Both arrays utilize Spectra Logic BlueScale encrypted LTO robotic tape libraries with automated nightly backups occurring for all work in process. **CSI maintains a disaster site** at a national co-lo to prevent interruptions in processing due to an act of God.

CSI's investment in state of the art technology and strict compliance to security processes assures that any **redaction processing performed for the AOC will be performed securely and exceeding the AOC's expectations** in turn around processing times.

CSI corporate networking is 1 Gb over fiber to Core Cisco 45xx catalysts with dual 10GB supervisor engines. All port access to CSI's core network is secured via CounterAct network access control technology provided by Forescout that limits all network access only to authenticated users prior to allowing any network access.

The data center is supported with two separate A/C units, a 40KVA UPS and a 60KVA Kohler diesel generator to allow for secure uninterrupted 24x7x365 processing for all CSI customers projects and the facility is located on an emergency services power grid as the facility is adjacent to the areas firehouse substation. The entire facility is supported by a separate 180KVA Kohler generator to ensure that validation staff performing work on customer daily processing projects can work uninterrupted in case of power failures too.



CSI blade chassis 1-4 Processing Resources for Back Filing Operations

Manual Redaction Validation at CSI

CSI employs **45 full time subject matter experts** using portrait format high resolution LCD monitors to perform manual validation processing of its software redaction projects. The redaction validation staff is composed of three distinct teams, with teams being split so as to provide checks and balances for spot-checking production work accuracy as a project progresses. Each team works standard business hours to eliminate changes in native sleep patterns from affecting job accuracy and performance required by staggered shift processing.

Each subject matter expert undergoes initial training that consists of classroom instruction, followed by **validation of documents from multiple jurisdictions** – using different types of fields and document classes – to test their learning of training materials. Upon completion of training, each individual is **required to pass accuracy tests** using previously scored (and selected as difficult documents) to verify that they developed the necessary attention / level-to-detail required to accurately process production documents.



CSI Validation teams in action

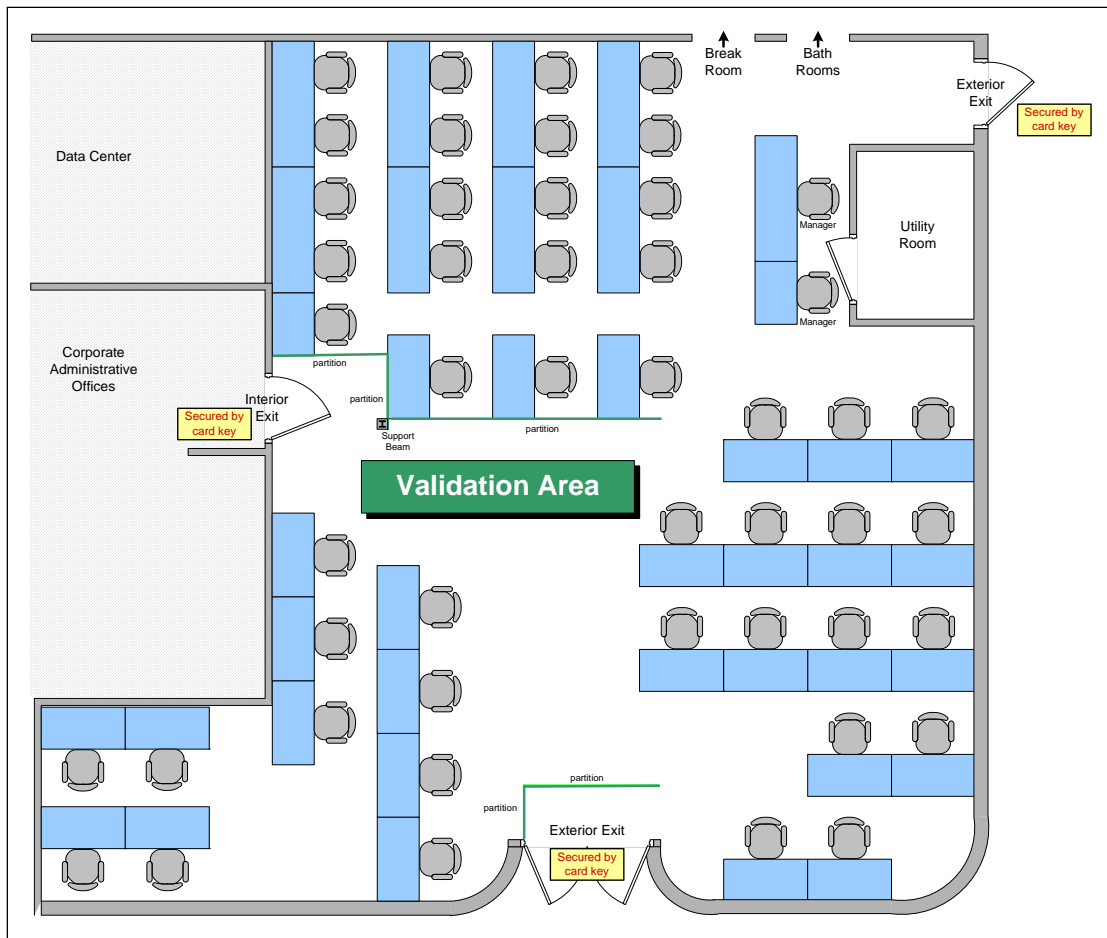

Validation Area Schematic

Review and Acceptance

Describe the process used by the clerk to review and accept or reject redactions during an interactive redaction process.

Manual validation is described in great detail starting on page 4-7 of this RFP Response. In summary, Intellidact automated processing categorizes four colored queue classes based upon the degrees of difficulty in not only converting characters, but in the complexity of logic used to produce a redaction candidate. The queue classes are red, yellow, green, and gray.

- Images placed in the red queue call for mandatory inspection of instrument types where an expected field such as an SSN was not found. Instruments such as death certificates, military discharges, and IRS forms usually require SSNs, however as requirements vary among jurisdictions, Intellidact allows this setting to be easily adjusted.
- Images placed in the yellow queue are those for which Intellidact performed a significant amount of complex logic to identify redaction candidates, or for conditions that could benefit from manual inspection. Images containing account numbers, handprint, cursive script, and ones having identifying keywords – but no relevant data – will appear in the yellow queue. It is important to note that yellow queue images may or may not contain

redactions, and IntelliValidate allows the user to select this as one of its many search options in validation processing.

- Images placed in the green queue are those for which Intellidact has had the utmost confidence in finding and redacting eligible fields.
- Images placed in the gray queue are those for which Intellidact has had the utmost confidence in not finding any redactable fields.

As presented to the Validator, a field that was automatically found is highlighted in color. If the redaction is correct, no “acceptance” action is required. If a highlighted redaction is incorrect, it can be either moved, resized, or deleted by mouse or keyboard shortcuts. If a redaction is missing, the Validator can either use the mouse to lasso a rectangle over the desired text, or use IntelliValidate’s Quick Draw feature to highlight and select text based on underlying OCR.

Besides QuickDraw, IntelliValidation contains other visual aids for users to identify potential redaction candidates:

- Phrase highlighting shows keywords which can indicate that redactable text is nearby, such as “Soc Sec #”.
- Dynamic Suggestion™ highlights text recommended for review / redact, pending other redactions on the existing image, such as a previously-identified 9-digit SSN embedded in some other number on the page.
- RapidReview™ highlights, by default, any 4-digit number on the page. Rapid Review can be optionally set to highlight any static text or regular expression.
- Stateful Inspection™ examines all pages in a document or sets of documents, allowing the validator to rapidly find and redact repeated information.
- Intellidact 3D™ provides an additional software pass after manual validation to ensure all changes made or accepted by a user are consistently applied across the entire document allowing us to achieve 99.95% accuracy.

Person Identification

Describe your approach to identifying information that is to be redacted.

Names are identified by two processes: automatically within Intellidact Grid processing, and on-demand within IntelliValidate. Following is an overview of the methodology:

Grid:

- By context: Intellidact use of a “key phrase” such as “Defendant”, “Plaintiff”, “Victim”, “brother of”, etc. to identify a region on a page where a name may be present. Names are identified as 2, 3, or 4 words in UPPERCASE or Proper Case (initial cap) in proximity to a key phrase.
- A CSI-supplied dictionary of names (complete FirstName LastName) can be matched to a text string on a page. The match fuzziness is set to 80% (and is customizable) to account for any OCR errors.
- A single method, or both of the above, can be implemented in whichever priority is desired.

IntelliValidate:

- On-demand: There is a Find Names button available to manual validators. When the button is pressed, a dictionary lookup occurs against every OCR-ed word on the page against a dictionary of the most prevalent last names in the USA as supplied by the Census Bureau. (Prevalent meaning occurring 100 or more times within the American population of 300+ million.)
- If a last name is located, a search ensues for a first name preceding or following the last name. Once again, a dictionary of prevalent first names supplied by the Census Bureau is used.
- Both first and last names allow fuzzy matching at 80%.
- Middle names or initials are accommodated, up to four elements FN MN LN LN. Two last names are permitted as compounded married names, or as Spanish surnames.
- Prefixes such as “Mr.” and “Dr.” are included, as are suffixes such as “Jr.” or “III”.
- Additional criteria, such as consistent use of UPPERCASE or Proper Case (initial cap) are used to further match name elements. The font size of the name elements should also be consistent, to rule out false positive matches.
- Nicknames are matched to formal first names, so if Intellidact finds “ELIZABETH JONES” on a page, it will also find “BETTY JONES”, “LIZ JONES”, etc.

**THIS PAGE CONTAINS CONFIDENTIAL INFORMATION
(Highlighted in Red)**

System Architecture

Execution Environment

Describe the platform(s) on which your solution runs. Provide an overall execution architecture topology diagram(s) that represents the platforms that your system uses, the software components on each platform and the connections and protocols between each platform. Include a statement regarding your recommended technical environment, being specific about network, server, and workstation requirements.

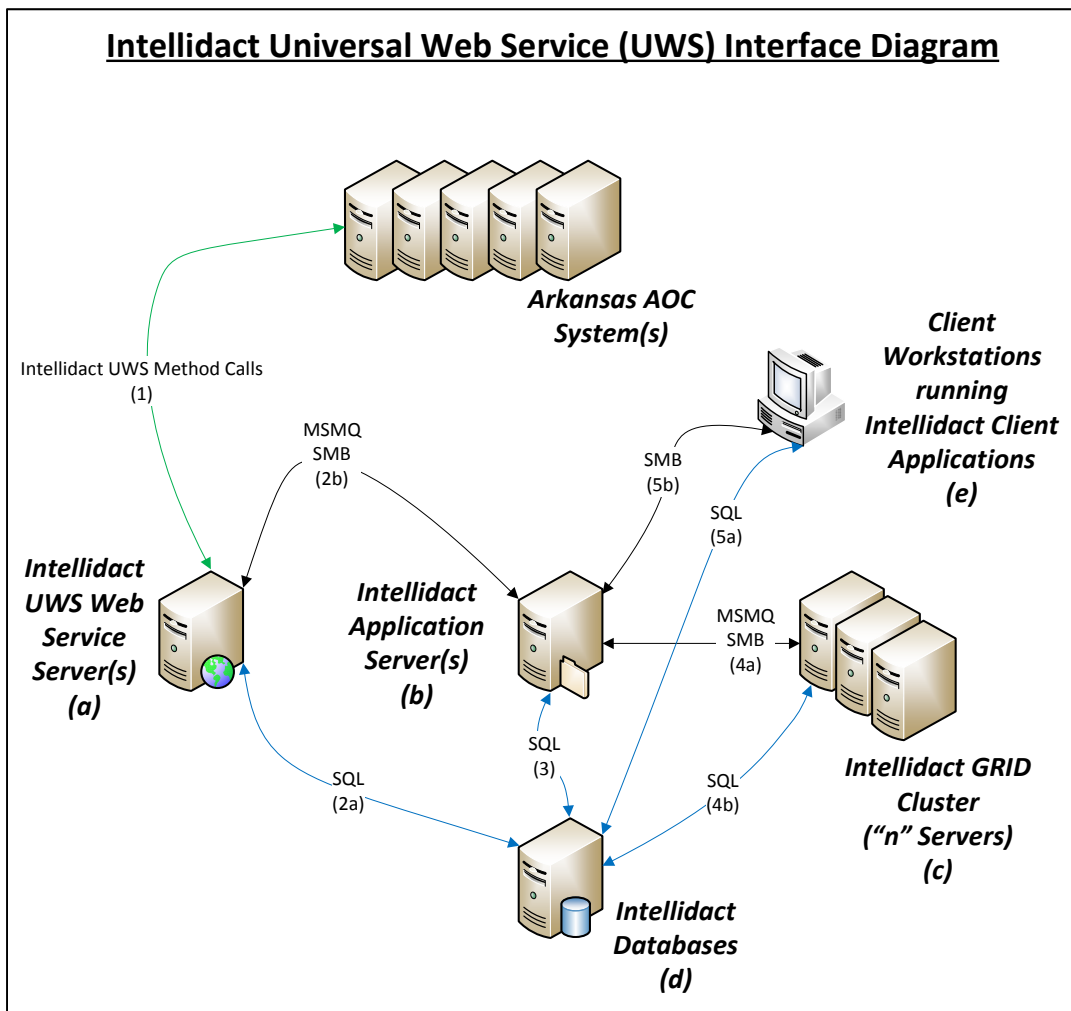

- (1) Arkansas AOC System(s) sends a request to a method on the Intellidact UWS Web Service
- (2) Intellidact UWS Web Service stores the received message in an Intellidact database (2a) and queues image(s) to process on the application server (2b)
- (3) Intellidact Application Server workflow system triggers off the new transaction within the Intellidact database and creates a new Intellidact workflow

- (4) Intellidact Application Server submits the unit of work within the workflow to the Intellidact GRID for processing via Microsoft Message Queuing
IMPORTANT NOTE: UDP Multicast traffic must be permitted between all servers in the Intellidact GRID cluster

{When virtualization is used the UDP Multicast must be permitted between the virtualized servers and the host themselves to which the virtualized servers may migrate as well}

- a: The Intellidact GRID pulls the unit of work to process from the Intellidact Application Server (or dedicated storage device) via SMB from a UNC Share
- b: The Intellidact GRID stores all transaction output in the Intellidact database
- (5) Client workstations running Intellidact Client Applications can validate workflow transactions and monitor workflow transactions status
- a: Intellidact GRID transactional data and/or workflow transaction status data is retrieved from the Intellidact database
- b: Intellidact Validation Client Applications pull the unit of work to validate from the Intellidact Application Server (or dedicated storage device) via SMB from a UNC Share

- (a) Intellidact UWS Web Service Server
Windows 2008, Windows 2008r2, Windows 2012r2
Features/Roles: Net Framework 3.5, IIS
Add-ons: Net Framework 4.0
Any failover and load balancing is expected to be handled at the hardware level
*Many times the UWS Web Service Server and the Intellidact Application Server are one in the same
- (b) Intellidact Application Server
Windows 2008, Windows 2008r2, Windows 2012r2
Features/Roles: Net Framework 3.5, MSMQ, IIS, File Services
Add-ons: Net Framework 4.0
The UNC File shares do not have to reside directly on an Application Server and can be from a centralized file server, NAS storage, or any other storage system that can offer SMB/UNC file shares
*Many times the UWS Web Service Server and the Intellidact Application Server are one in the same
- (c) Intellidact GRID Server
Windows 2008, Windows 2008r2, Windows 2012r2
Features/Roles: Net Framework 3.5, MSMQ
Add-ons: Net Framework 4.0
- (d) Intellidact Database
SQL Server 2008, SQL Server 2008r2, SQL Server 2012 (for 2012 the database must be in SQL 2008 compatibility mode)
The database server can be a dedicated SQL server for Intellidact or the hosting of the Intellidact databases on a centralized SQL server
- (e) Client Workstation
Windows XP, Windows 7, Windows 8
Add-ons: Net Framework 3.5, Net Framework 4.0

Describe which operating systems are supported for each platform (include versions supported). Include what percentage of your installed base is using each operating system in production today. Provide a statement explaining the technical environments in which you have implemented your product for other customers and the number of each.

Windows server 2012 and 2008 for server based components. Windows 7 or XP for client based components.

We don't maintain platform version counts for our 500+ installations.

We do certify our software for vmware environments as well as have the majority of enterprise customers that deploy on such.

For each operating system supported, provide your minimum and recommended CPU, RAM and hard drive requirements and upon what assumptions these minimum and recommended requirements are based.

IntelliGrid

The Intellidact database is implemented so that multiple processes can be run simultaneously on multiple servers. This is called the Grid. Each Grid server must have a minimum of 50 gigabytes of storage available post Intellidact installation. Each Intellidact Grid server has the following installed:

- Services Manager - installed on all GRID servers, but is active on only one GRID server at a time.
- Image Processor - Each CPU in a GRID server runs an instance of the Image Processor.
- Redaction/Extraction Engine - the software that performs OCR/ICR and data location on images passing through the Intellidact Image Processor

Each IntelliGrid instance runs on a separate CPU core. Each CPU core or instance of Intellidact requires 1 GB of memory. Therefore, if a server has four CPU each with four cores and all 4 cores have been configured to run Intellidact, at least 16 GB is required for that server. Since the Grid is scalable, you can add as many servers and CPUs as you wish to meet throughput requirements.

Database

CSI supports and recommends MS SQL Server 2008 or later. All Servers should have a minimum of several gigabytes of storage space available post-installation. Storage requirements are dependent upon processing volume.

*Minimum Server Specifications**

# of Servers	CPU	Post-Installation Storage	Allocated Memory Per Core
1	Dual Core CPU	60 GB	1 GB
1	2 Dual Core CPUs	120 GB	2 GB
1	4 Dual Core CPUs	280 GB	3 GB
2	4 Dual Core CPUs	560 GB	4 GB
2	4 Dual Core CPUs	1.2 TB	8 GB
2+	4 Dual Core CPUs	2.8 TB	16 GB
2+	4 Dual Core CPUs	5.5 TB	32 GB

* These numbers are estimates for dedicated Intellidact servers only and are based on average data use with corresponding storage requirements. Servers with non-Intellidact services and programs installed alongside Intellidact applications will require more memory and storage availability than shown here to compensate for the workload. CSI does not support installing Intellidact products on servers handling Domain Controllers, email, ERP, Order Processing, or servers with high traffic.

Intellidact Workflow Server (IWS)

The IWS server handles workflow components within the Intellidact system. The IWS Server requirements are as follows:

*Minimum Server Specifications**

# of Servers	CPU	Post-Installation Storage	Allocated Memory Per Core
1	Dual Core CPU	50 GB	4 GB

* These numbers are estimates for dedicated Intellidact servers only and are based on average data use with corresponding storage requirements. Servers with non-Intellidact services and programs installed alongside Intellidact applications will require more memory and storage availability than shown here to compensate for the workload.

Web Server (IIS)

The Web (IIS) Server handles the Intellidact Web application components. All servers running Intellidact applications should have a minimum of several gigabytes of storage space available.

*Minimum Server Specifications**

# of Servers	CPU	Post-Installation Storage	Allocated Memory Per Core
1	Dual Core CPU	50 GB	2 GB

* These numbers are estimates for dedicated Intellidact servers only and are based on average data use with corresponding storage requirements. Servers with non-Intellidact services and programs installed alongside Intellidact applications will require more memory and storage availability than shown here to compensate for the workload.

Describe which modules or components come with your base product. Please indicate which additional components are available.

Base:

- Intellidact Database Schema
- Intellidact Web Administrator (WebAdmin)
- Intellidact Services Manager
- Intellidact Image Processor
- Intellidact Grid
- Intellidact Redaction Rules configured for your redaction requirements
- Intellidact Management User Interface (Grid MUI)
- Intellidact Validation

Optional:

- Universal Web Services API (UWS)
- Intellidact Workflow Services (IWS)
- Intellidact Document Manager (IDM)
- E-file workflow agent (ECF 4.0 XML input)
- E-recording workflow agent (PRIA XML input)
- Total Case™ (Case specific redaction across all documents)
- Intellidact Search™ (Enterprise search for all processed documents)

List any pre-requisite software required for implementation on each of the platforms.

- Intellidact Database – Each Server
 - Windows Server 2012, or 2008
 - MS SQL Server 2008 or later

- Intellidact Web Administrator (WebAdmin)
 - For the Web Server:
 - Windows Web Server with IIS
 - Microsoft .NET Framework 4 installed
 - ASP .NET
 - MS Message Queue (MSMQ) installed
 - For Browser Clients:
 - Microsoft Internet Explorer (IE) 8 or above

- Intellidact Services Manager
 - Windows Server 2012, 2008
 - Microsoft .NET Framework 4.0+
 - Message Queuing (MSMQ) – with Active Directory Integration option
 - All Grid servers need to be on the same subnet

- Intellidact Image Processor
 - Must be installed on the same servers as the Intellidact Service Manager

- Intellidact Management User Interface (MUI)
 - Windows Server 2012, 2008
 - Microsoft .NET Framework 4.0+
 - Run from a machine inside of the same subnet as the Grid

- IntelliValidate
 - Windows Server 2012, 2008, Windows 7+ or WinXP
 - Microsoft .NET Framework 4.0+

- Intellidact Document Manager (IDM)
 - Windows Server 2012, 2008, Windows 7+ or WinXP
 - Microsoft .NET Framework 4.0+

Describe any other application packages that are inherent in the software that will require contracting from a different vendor.

None.

List protocols or middleware products used for communications between platforms or tiers.

TCP/IP, ICMP Multicast, Microsoft Message Queuing (MSMQ).

If a third-party application server is used in your solution, indicate the product or products that are used.

None.

Describe the database platform if applicable. State whether the database is specific to the product and whether the database can be customized and how.

Microsoft SQL Server 2008 or later. (Note: MS SQL Server 2005, with SP3 is minimally supported, but is not recommended for optimal performance.) The Intellidact database is specific to Intellidact and we do not expect clients to make additions or modifications to it.

Describe the design of your error handling. Describe what happens in the case of an error; how errors are logged and how they are resolved, including how they are communicated to the client.

Error handling from all modules within the application make use of a common error handling framework to ensure consistency in error reporting and level of details provided.

This common framework has the ability to log to operating system event logs, application transaction logs (in XML format), or a centralized database. There is a dashboard provided that includes current and historical error status of all processing modules, and client notification via email or text message is provided for as well. The extent of logging and alerts is configurable based upon client requirements.

Describe external interfaces that exist in your solution. Describe the method used to access data or applications within the solution from an external application. State what type of application program interfaces (APIs) exist for providing this interface. (An example might be an inline redaction process that conducts OCR and redaction on a non-redacted image in a database prior to delivery to the requesting user's web browser).

CSI provides external system interfaces via various easy to use methods, as well as developer training in each as required.

Modern day system interfaces are primarily via web services (Intellidact provides "UWS – Universal Web Service" as our enterprise system buss that is a subscriber based system. It supports numerous callers and numerous applications via a single web service and brokers submission to an appropriate back end instance if running multiple application tenancy (i.e. one web service, multiple Intellidact redaction projects all running on a single Intellidact compute grid). Intellidact UWS is well documented and provides wsdl and .xsd and is the primary programmatic interface of modern system integration.

For legacy systems incapable of supporting web services, Intellidact provides the more primitive interfaces for file drop and database triggers, but, we prefer use of web services.

Intellidact also provides for support of ECF 4.0 / NIEM 3.0 transactions which allows it to natively process e-filing transactions that conform to the Oasis national standards.

Our vendor-neutral design lets third-party companies submit and retrieve documents to/from Intellidact for redaction and other services.

For integration efforts we provide integration partners with remote VPN access to isolated virtual machines hosting the services from our data center to assist in their integration efforts

If integration with e-mail, fax, other text messaging products, or word processing or spreadsheet programs is included in the solution, indicate the products with which it interacts and explain how your product interfaces with these solutions.

Intellidact has several interfaces to be able to process documents received from fax and email servers, and the ability to redact from within Microsoft products.

If integration with multimedia products is included in your solution, indicate the products with which it interacts and explain how your product interfaces with these solutions.

Not applicable.

Describe any system maintenance functions that cannot be completed while the system is in full operation.

The Intellidact database is the central hub for all Intellidact components. If the database server is a non-clustered environment and the database server is shut down for maintenance (e.g. upgrades, backups), then no work can proceed.

However, all configuration-related changes (e.g. new redaction field definitions, user definitions and permission changes, etc...) can be performed while Intellidact is in full operation and processing resources can be added or removed while the system is "hot".

Describe how your system integrates with document management systems and the process for integrating with a new document management system.

Intellidact provides native integrations with leading DMS systems to protect your investments in Intellidact redaction processing technology and services

What method we will use will be determined by the level of integration that you desire to utilize if not using one of the major DMS vendors. As an enterprise redaction solution, and not a specific DMS/CMS solution, we provide universal web services that may be used to submit and retrieve documents as well as obtain document processing status and processing audit history. Use of UWS allows Intellidact to be integrated within any application, workflow, or document management system in use by AOC or individual Arkansas counties.

For integration with a new DMS we would expect to be provided with information as to the vendor so as we can research if an integration already exists. If none exists we would expect to know the desired preference for integration (i.e. modern web services, or more primitive “file drop” exchanges), we would then expect to know where in the workflow the integration was desired. Common integration points are on document capture/arrival, after document storage, or upon demand. Upon having this knowledge we would then work with the DMS vendor to test the the appropriate Intellidact interface/integration end points and assist in development of any new methods.

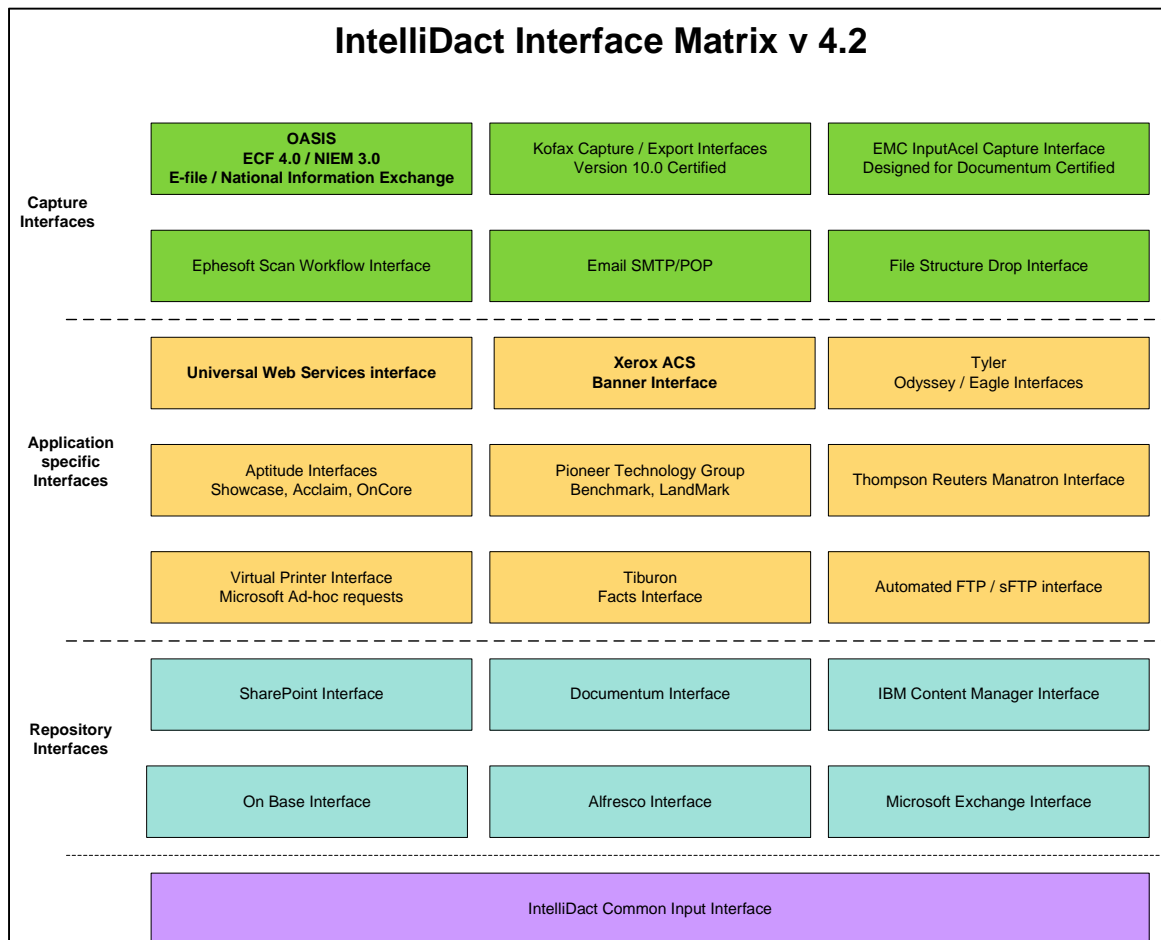

Describe whether and to what degree your system will integrate with the Xerox Contexte case management system.

As we have interfaces to Xerox/Banner we would expect that full integration would exist with both Intellidact and Xerox Contexte systems. However this depends on the integration points available from Contexte. By full integration we mean redaction on demand, redaction on arrival, and redaction document status/audit functionality is possible.

Intellidact does provides an enterprise service buss (Universal Web Services - "UWS") as a subscriber-based web service that can be utilized by Contexte (or other systems). UWS is the primary interface for our dozen or so other case management/land record system vendors.

Intellidact also supports ECF 4.0 / NIEM natively and as Contexte documentation states it is built for NIEM possibly those existing integration points exist to provide full and out of the box integrations.

Performance, Scalability and Reliability

List the key factors that drive the solution's performance and what tools/capabilities exist to tune the performance.

The Intellidact Grid when performing image processing is CPU intensive. The more servers/cores you have, the more concurrent work can be performed by the system to increase processing performance. The Intellidact Management User Interface (MUI) monitors compute grid performance. If more throughput is desired, the MUI allows you to configure the Grid with additional CPU resources.

In high volume processing situations, the Intellidact database itself should be located on a dedicated server so that it does not contend with other applications. Standard data base vendor performance tools are used to monitor and tune its performance.

Identify any limitations related to transaction volumes.

Data center heat load, A/C and power availability for your data center or computer room. The Intellidact Grid is enterprise scalable to thousands of CPU cores. Since parallel processing is occurring, the only limitation is how many CPU cores you have available for use.

The database is subject to transactional limitations based on disk I/O as well as network speed between servers.

Describe current SLA's (Service Level Agreements) that are used with your clients. Make sure system availability is addressed.

CSI's current standard SLA consists of the following sections:

Declaration of Parties to the Agreement

(1) Definitions and Identifications

(2) Agreement to License

(3) Fees, Installation Charges, and Taxes

(4) Delivery and Acceptance

(5) Payment

(6) Warranty, Exclusions, and Disclaimer

(7) Functional Specifications

(8) Training

(9) Maintenance Agreement

(10) Software License

(11) Restrictions Upon Disclosure of Confidential Information

(12) Intellectual Property Rights

(13) Protection of Software

(14) License Termination

(15) Excusable Delays

(16) Miscellaneous Provisions

Signatures

Regarding response times:

“CSI will use its best good faith efforts to respond within four (4) hours (but only during the Basic Maintenance Period) of notice from COMPANY of the need for Conformity Maintenance Services or notice of a request for Online Support or Telephone Support. Any such notice from COMPANY shall, to the extent possible, identify all Critical Defects, and, in connection with the provision of any Conformity Maintenance Service, Online Support, and/or Telephone Support, COMPANY shall, at its own expense, provide its full good faith support and cooperation with CSI's efforts at resolution. CSI will use its best good faith efforts to correct all Critical Defects within twenty-four (24) hours after notice from COMPANY of the applicable Critical Defects. Non-Critical Defects as agreed to by CSI and the COMPANY will be corrected, if correction is reasonably possible, before the earlier of: (a) sixty (60) days following the date of next release (following notice of defect from COMPANY) of an Enhancement relating to the applicable Software component; or, (b) one (1) year following notice of defect from COMPANY. In this instance of a non-critical defect, CSI is to provide the COMPANY with alternative solutions to address the defect within a reasonable time.

“Other defects must be corrected within a reasonable time based on the nature and severity of the defect but no later than 60 days following notice from the COMPANY unless CSI presents the COMPANY with an acceptable alternative method or means to address the defect.”

Describe your performance benchmarking. Please provide supporting documentation on your benchmarking methods.

System performance benchmarking is available from Intellidact's management user interface and provides access to process execution timings from each CPU core performing Intellidact processing functions. Our customers routinely run hundreds of millions of images in their CPU grid and end to end transaction timings are provided via the management user interface.

If the question is in regards to redaction accuracy performance of our processing as CSI was requested to provide the accuracy section for PRIA's white paper on best redaction practices, we have included as an addendum to your RFP the CSI white paper the PRIA material was extracted from, *Intellidact Accuracy Methodology* for your review of our redaction accuracy benchmarking methods.

Of course the best calculation of accuracy is provided by our customers using their own scoring; as such we have **included within the appendix an RFP scoring sheet** available from the **Sacramento County California's Recorders office**. Across the top of the sheet are vendors that responded to this national RFP, we have identified in parenthesis the redaction technology used by vendors that rebrand 3rd party products as their own. CSI's Intellidact redaction technology is the **only vendor to receive perfect accuracy scores** in offsite back file processing and validation, as well as real-time onsite processing, in compliance with California requirements. Sacramento County scored Intellidact **7 times more accurate than the second place finisher (Mentis)** and **5 times more accurate than the third place finisher (Extract Systems)**. In addition, Intellidact also received perfect scores on ease-of-use.

Note that the maximum score for the line item is also provided, and that CSI is the only vendor to have received perfect scores in the accuracy and ease of use categories, with CSI being between 3 and 7 times more accurate in the identification of just simple SSN data. Needless to say, **more complex court data for future proofing** or guarding against legislative changes has more astonishing results.

Describe your largest installation (number of concurrent users, transaction volumes, performance, response times, image database size, number of sites and distance between sites, etc.).

Note our largest installation of Intellidact is CSI's data center on over 1,700 CPU cores and processes 15M images / week but for purposes of a large CSI customer we will use Palm Beach as a reference as they have roughly 160 million images processed by Intellidact to date.

Palm Beach County Clerk of Courts (Florida):

- Average number of concurrent users: 500 (aggregate across ACS/Banner CMS, CourtView Showcase CMS, and New Vision Land records systems)
- Users defined in the system: 700+ (including validators, managers, supervisors, IT personnel, etc.)
- Grid processing speed: 2.7 to 15 seconds per page based upon text density and document cleanliness
- Volume:
 - Approximately 600,000 documents/month in 2013
 - Approximately 2,100,000 pages/month in 2013
- Database size:
 - Intellidact DB: 1.2 TB
 - Note: Images are not stored in the database
- The Palm Beach Clerk of Courts office is in four physical locations:
 - Main – West Palm Beach
 - North – Palm Beach Gardens – 13 miles from Main Courthouse
 - South – Delray Beach – 21 miles from Main Courthouse
 - West – Belle Glade – 42 miles from Main Courthouse

Identify the maximum number of concurrent users doing update, query and reporting that your solution can support, and identify the architecture components that impose these limitations.

The maximum number of concurrent users able to operate the user interface client is restricted by the Microsoft SQL server hosting the Intellidact system's databases not by Intellidact software.

The maximum number of images that can be processed per hour is limited by the number of server side CPUs made available for the Intellidact server side software not by Intellidact software.

Describe how one would scale the current application and describe the additional infrastructure upgrades to your system requirements that would be necessary to accomplish it. Describe actual episodes, including the outcome, where you have had to scale the platform for your customers.

Intellidact was architected to be an enterprise scalable solution. The entire system (grid as well as workflow services) can quickly and easily scale by simply adding hardware and Intellidact instances to the configured environment. Once available the system is self-tailoring, will recognize the hot add additions and immediately start using them to process your existing document workload. In addition to being easily scalable, Intellidact provides you with centralized management consoles so you can see the current workload and any backlogs that may

be within the compute grid or workflow subsystem.

If the throughput of image processed per hour needs to increase beyond the capacity to which the current number of CPUs can support, one simply needs to add more CPU cores/servers to the Intellidact server-side Grid. The Intellidact Grid will then initialize these additional CPUs and process a higher quantity of images per hour, and this scales linearly to processing tens of millions of images. Note also there are no additional charges for adding servers as processing resources.

If the throughput of a particular workflow agent (i.e. document release) needs to increase, you simply install another instance of the specific workflow agent on a server that has available resources to accommodate it.

Whenever an expansion is needed, our support team is also available to assist you in expanding your environment. If your SQL Server can no longer support additional users, CSI Support staff would assist you in whatever strategy you chose to increase the resources for Microsoft SQL Server. When the current server hosting Microsoft SQL Server is upgraded, we would assist you in shutting the system down, allowing you a maintenance window to upgrade the hardware, and then assist you in making sure the system is properly back online following the upgrade. If the current SQL Server is determined to need replacement with a newer server, CSI Support staff would assist you in migrating the databases from the current Microsoft SQL Server to the new Microsoft SQL Server. This would again entail assisting you in shutting the system down, assisting in moving the database MDF and LDF files to the new server and reattaching the SQL Databases on the new server, and assist them at the end in making sure the system is properly back online following the migration/move. All covered under our software support and maintenance.

Describe the means of monitoring application performance and any ability to place alerts on critical measures.

The Intellidact Management User Interface (MUI) permits real-time monitoring of all Grid processing instances. The MUI is a centralized console capable of providing error status as well as alerts to operational personal not just of hardware malfunctions but of image processing that is outside preset definition guidelines.

For Intellidact workflows, the Intellidact Document Management program (IDM) provides a real time dashboard of all document queues for validation and other processes. Both programs show alerts on critical events and can perform email notification as well.

Explain whether your solution would meet an uptime requirement of 99.7%, and whether your system is available to clients on a 24x7 basis.

Intellidact has been architected for “five nines” availability (5.26 minutes of downtime per year) with provision of multiple workflow agents being able to operate on difference servers/vm’s and our specific Intellidact compute grid architecture.

The Intellidact grid provides both redundant and self-healing capabilities a single head node but any compute node being capable of promotion to a head node. It is customer hardware

architecture and network infrastructure that is the determining factor of a 99.7% uptime capability, Intellidact software has been designed as well as proven to operate in a more demanding “five nines” environments. Individual Intellidact software components can be disabled for hardware maintenance from their appropriate management consoles with duplicate instances absorbing the workload.

CSI’s data center employs 1,700+ cpu cores in four Dell M1000E chassis and runs complete hard redundancy. This includes SAN storage, internet connectivity, and diesel generator N+1 capability as we process images 24x7x365 and have been doing so for the past ten years.

Data Access/Privacy/Integrity

Describe your approach to data security. State how you ensure that data is secure from unauthorized access by internal employees and external entities.

Processing Integrity

For all processing performed, CSI maintains its own independent data center located at its corporate headquarters in central Florida. Physical access to CSI's data processing and validation facilities is controlled via RFID keycards provided and monitored 24x7x365. The facility is OSHA and PCI DSS compliant; Temperature, fire, smoke, digital facility video, and burglar alarms are also monitored 24x7x365. Access to the data center and validation work area is limited to those requiring access, by additional authentication provided by a separate employee badge reader.

All remote access is via IPSEC VPNs authenticated by one time passwords and only to specific subnets. All processing is performed on customer specific virtualized infrastructure so there is no sharing of processing resources for customer processing. Storage of data is provided for using separate storage area network LUNs with data backups performed on AES 256-bit encrypted media.

Data leakage / theft is eliminated by use of PointSec port protection locking down all validation stations so that only authenticated users may validate images and not copy/print data for unauthorized use. Corporate data protection is provided for by Check Point Unified Threat Management clusters with IDS, and IPS software blades with Data Loss Prevention being provided by a Check Point DLP appliance as well. All network security alerts are monitored by CSI's network security staff, a separate division of CSI.

CSI employs FIPS / industry standard encryption technology for either "data in motion" or "data at rest" in all processing provided for AOC. Data security is provided for by a separate division of CSI that deals solely with corporate enterprise data security.

Confidentiality

CSI maintains stringent control on its staff utilizing only vetted US citizens in a controlled work environment allowing access to the facility and information only during business hours. All steps in processing are audited and the layout of the validation facility allows complete transparency into validation staff actions.

Should any incident that affects the confidentiality of AOC information occur, CSI security team staff will immediately notify AOC of such and the remediation steps taken.

CSI facility and processes are responsible for the secure processing of over 4.5 Billion images to date without a single security incident occurring or image being compromised. Our data transfers, data storage, networking, data access, data processing, and data validation processes are well established and proven as being state of the art and performed by vetted subject matter experts.

Media Disposal

Either upon termination of the above storage, or immediately upon customer acceptance of images processed by CSI, CSI will automatically clear and sanitize all media (either portable or fixed) that contained AOC data and images following the Department of Defense's standard for eradication of confidential data.

DoD 5220.22-M - *"Overwrite all addressable locations with a character, its complement, then a random character and verify"* for clearing and sanitizing information on writable media.

Describe how concurrent updates to a single record are prevented.

Standard database row locks are in place for records being updated.

Describe your data access design, giving particular attention to transaction management.

All application software uses an in-house data access layer (an object-relational mapping (ORM) framework accessing relational data using domain-specific objects) that is database agnostic (can be easily configured to use MSSQL, Oracle, Informix, etc...however the majority of our customers are SQL server).

Transaction management, is dependent on the business case for the given function (some implicit and others explicit transactions).

System Security

Describe the user administration process required for your product.

User administration is handled via standard Active Directory user/group management. AD users/groups are imported into Intellidact where they are assigned specific document and Intellidact subsystem processing rights.

Identify the different levels of security that are available. Security must be based on any combination of data element value, transactions type (e.g., add, update), application level (e.g., catalog, sub-catalog), user ID (e.g., individual, group, manager) or device ID (terminal or workstation that the user is working on).

In IDM, user IDs can be assigned to groups (as granular as you desire) and given privileges for both programs as a whole, and also for individual program features. For example, end user Validators can be defined for individual document types by department, if you wish to maintain separate groups of workers who cannot see or modify each other's work.

List any audit reports you provide. Identify the key report fields such as element, user ID and timestamp. Describe how the reports can be used to identify security violations and data corruption. Also, list any other security reports that are available, such as password violation reports or active user list.

Audit reports within the Intellidact Document Management program (IDM) display a plethora of information, including user, timestamp, and action. IDM also displays and manages the active user list. Since Intellidact applications use login IDs linked to Active Directory, no security violations should occur at the application level if network domain security is in place.

Describe encryption technologies used by your product.

For projects where content is transported between locations, TrueCrypt is used to encrypt all content at the entire disk level. TrueCrypt ensures that only the parties with the proper software and associated encryption keys can even read the drive. To all others the drive appears unformatted and useless.

For web services transactions, https or ipsec vpn's using http are standard.

Describe the user registration, password reset, and new user creation process.

IDM controls all Intellidact user IDs, which are linked to Active Directory (see previous answer above regarding IDM user maintenance). For example, if you log onto a machine with a domain ID which matches one in IDM, you're automatically granted permissions to the appropriate Intellidact programs. Alternatively, you can create local Intellidact IDs in IDM which are not linked to Active Directory – passwords for these can be set by the user at first login, and reset within IDM.

Development Environment

Describe your development methodology and development team structures. State what quality and process improvement programs are in place. State whether there have been any assessments of the development process (e.g., SEI or ISO).

Agile Scrum is the methodology with test driven development (Nunit). Development quality process improvement is management of defect cases by tracking of such and adjustments to unit and integration tests that are automatically applied upon subsequent code check-ins and regression testing. We have not had third party assessments of our practice.

Describe your code management process. Include your versioning strategy and how often new versions of your solution come out. State whether you do point fixes or whether all fixes are packaged into the next release. Explain whether, if point fixes/patches are made for one client, that affects another client. Describe your process for releasing a new version of the software.

Code management is centralized using a subversion repository however will be changing to git within the next year to accommodate branching per feature/bug fix or modern “branchlet” development. Versioning of components is automatically handled upon check in / successful build.

Major product versions are once per year, feature enhancements/service packs are three times per year. We do have the ability to provide continuous software releases daily however we have not found a customer that can absorb such in their operations.

Hot fixes are available upon critical problem identification and resolution.

Software releases / deployments are automated and require no manual configuration as customer environment profiles are established which utilize previously defined variable substitution of all configuration values necessary for successful (and repeat) installs.

Describe the maintenance (bug fixing) process used. Include who is responsible for the maintenance of the system, and how you track issues/bugs communicated to you by your clients. Explain your policy regarding correcting these bugs. State how quickly bug fix requests are fulfilled, and how these corrections are communicated to the client. Describe the process and policy for client installation.

Issues/bug reports are provided by the customer via the CSI support portal, email, or a toll free phone number. CSI software also provides for automatic creation of notification to CSI should it encounter an error condition and the customer has configured the software for automatic notification to CSI. Bugs are assigned to blocker, critical, minor, and trivial categories upon creation and individual customer SLA's determine the response times CSI provides. A good rule of thumb is Blocker gets immediate development team attention (i.e. Tier 3 support) until resolved, Critical is development team attention within two hours of receipt at CSI, Minor escalates to Tier 3 development team support within 2 business days, and Trivial within 1 week. Communication to client is via assigned support engineer, installation is either performed by CSI support or the customer with CSI support assistance and via the structured automated release process provided with Intellidact.

State how many developers are dedicated to development and how many to bug fixes. Describe how you deal with version changes to third party software, including database and operating system software, and your policy for adopting them.

Bug fixes are addressed as a sprint to assist those in making a mistake with being able to improve their knowledge level so as not to make a mistake the next time. There are a total of 15 developers assigned to the Intellidact product line.

Version changes to third party software, or changes to the vendor of a specific piece of functionality provided by third party software are handled with our packaging and use of third party software. All third party software is packaged into specific nuget packages and production (i.e customer) use of a particular version is isolated by provision of developers commit/automated builds being able to only utilize the production code nuget feed. Changes in versions are provided via a developer nuget feed, that before being promoted to the production nuget feed have all affected software modules (i.e. those with dependencies) auto built and regression tested.

Our policy for adopting database and operating system software changes are when they become release candidates our software is certified on them within 30 days.

Describe the development tools used to create your product, including programming language(s), report writers, etc.

Microsoft Visual Studio 2013, C# as the primary programming language, Test Driven Development is employed as a development methodology, Team City is used for Continuous Integration, and Octopus for Continuous Deployment.

As Intellidact is an enterprise product being utilized at hundreds of customers, we firmly believe in state of the art development processes, procedures, and tools as well as application lifecycle management.

Discuss how the solution can be interfaced to other systems. Include a discussion of any tools or API's that exist to support the creation of interfaces to external systems.

CSI provides system interfaces via various easy to use methods, as well as developer training in each as required.

Modern day system interfaces are primarily via web services (Intellidact provides "UWS – Universal Web Service" as our enterprise system buss that is a subscriber based system. It supports numerous callers and numerous applications via a single web service and brokers submission to an appropriate back end instance if running multiple application tenancy (i.e. one web service, multiple Intellidact redaction projects all running on a single Intellidact compute grid). Intellidact UWS is well documented and provides wsdl and .xsd and is the primary programmatic interface of modern system integration.

For legacy systems incapable of supporting web services, Intellidact provides the more primitive interfaces for file drop and database triggers, but, we prefer use of web services.

Intellidact also provides for support of ECF 4.0 / NIEM 3.0 transactions which allows it to natively process e-filing transactions that conform to the Oasis national standards.

For integration efforts we provide integration partners with remote VPN access to isolated virtual machines hosting the services from our data center to assist in their integration efforts.

Minimum Requirements

Indicate whether and to what degree the proposed solution meets the following requirements:

The software is configurable, rules-based software that can be configured by AOC to keep current with changes to Arkansas redaction requirements.

Yes. Intellidact Grid processing uses an external “project” file which contains redaction rules. This file may be replaced with amended rules at any time, via CSI’s self-service update program. During any back file processing project for Arkansas, or while any forward filing project is under software maintenance CSI will make all changes to redaction rules to keep Intellidact redactions up to date with Arkansas redaction requirements. This will be provided for at no additional cost outside of any current software maintenance agreement. We do not expect our customers to have to learn complex regular expressions to maintain their compliance with redaction laws.

Redacted information is permanently removed from the document, not merely masked or covered up, and a new document is created.

Yes. Redactions are “burned” into the document. In other words, in the bitmap layer of a Searchable PDF, the redacted text is replaced with a black rectangle. In the text layer the redacted text is removed entirely.

All redacted images retain an accuracy rate of 98% or better with less than 1% false positive redaction return.

Yes. Intellidact Grid processing, along with IntelliValidate manual validation of suspect images, yields an accuracy rate in excess of 99.95%.

The software solution allows the ability to either auto-redact or OCR+1 manual review with images flagged with definite and suspect redaction candidates.

Yes. Intellidact processing via the Grid is automated, where sophisticated rules run on the OCR text, classify documents by type, and provide redaction area (x,y,w,h) coordinates. Images with high confidence levels can be released (OCR+0 or auto-redacted) at this stage.

Images that are questionable or have complex redaction logic applied to them can be automatically set to enter a manual validation stage of processing (OCR+1). The IntelliValidate manual validation program visually displays the results of Grid processing, and allows a user to review/add/modify/delete redactions. IntelliValidate also contains many visual aid features to assist in locating potential redactions, such as key phrase highlighting, dynamic suggestions, 3D analysis, etc. See *Advanced Validation Features* on page 4-7 for a detailed description of OCR+1 functionality available.

The software allows for manual redaction as ordered by the court.

Yes. IntelliValidate permits *ad hoc* redaction fields, which can be categorized as a “manual” field type.

In addition to this, Intellidact provides TotalCase™ technology to eliminate additional manual labor from having to inspect additional pages of all existing documents in the case and apply the same redaction.

Intellidact TotalCase™ provides the ability for redactions that are dynamically made to a document to be remembered for the case (i.e. collection of documents having commonality identified in processing such as a prosecutor case number) and then automatically applied to all documents in the DMS/CMS existing for the case. In addition, this remembered dynamic redaction data is then also used to apply to all new documents belonging to the case as they enter the system. TotalCase is highly effective in minimizing manual labor and note taking on privacy protection work required in court document environments as information exists that is specific to a case and not easily processed as static data such as SSNs.

The software has the ability to create both a redacted and non-redacted version of the image.

Yes. Intellidact exports both non-redacted (i.e. original) and redacted versions of an image in several different document formats based upon how it is configured to process. Such configuration is easily performed by an administrative user.

The software is able to read and redact both machine printed and handwritten images and unstructured data.

Yes. Intellidact's character recognition engine, provides for both OCR (optical character recognition aka machine print engine) and ICR (intelligent character recognition aka handprint) interpretation of unstructured image data. Intellidact then uses a voting engine to evaluate on a character by character basis whether the data returned by the machine print engine (OCR) or handprint engine (ICR) is of higher confidence. The voting engine then constructs complete words combining the best character results from either engine.

Most redaction vendors have the ability to redact handprint data locating such using machine print keywords. In most instances Intellidact has the ability to locate and redact handprint data using only handprint keywords.

Example Intellidact Handprint Redaction Absent Machine Print Keyword. Note the location of both a DOB and an SSN without requiring the assistance of machine printed keywords

The image displays two versions of a curriculum vitae for H. Massiha, M.D., F.A.C.S. The left version shows the original document with handwritten information in a red box: DOB: 12-11-75 and SSN: 427-11-5491. The right version shows the same document with the DOB and SSN fields redacted with black boxes.

Left Document (Original):

H. Massiha
#4307

HANID MASSIHA M.D., F.A.C.S.

CURRICULUM VITAE

ADDRESS: 3939 HOUMA BOULEVARD
SUITE 216 DOCTORS ROW
METAIRIE, LOUISIANA 70006
OFFICE: (504) 455-9442

DOB: 12-11-75
SSN: 427-11-5491

EDUCATION

M.D. Degree, Tehran University
1966

ECFPG Examination
1973

FLEX Examination
1973

POST-GRADUATE TRAINING

Desconess Hospital
St. Louis, Missouri
1968-1969

St. John's Mercy Medical Center
St. Louis, Missouri
General Surgery
1969-1972

Louisiana State University Medical Center
New Orleans, Louisiana
Plastic and Reconstructive Surgery
1973-1974

Louisiana State University Medical Center
New Orleans, Louisiana
Chief Resident
Plastic and Reconstructive Surgery
1974-1975

St. John's Mercy Medical Center
St. Louis, Missouri
Chief Resident General Surgery
1975-1976

Right Document (Redacted):

H. Massiha
#4307

HANID MASSIHA M.D., F.A.C.S.

CURRICULUM VITAE

ADDRESS: 3939 HOUMA BOULEVARD
SUITE 216 DOCTORS ROW
METAIRIE, LOUISIANA 70006
OFFICE: (504) 455-9442

DOB: [REDACTED]
SSN: [REDACTED]

EDUCATION

M.D. Degree, Tehran University
1966

ECFPG Examination
1973

FLEX Examination
1973

POST-GRADUATE TRAINING

Desconess Hospital
St. Louis, Missouri
1968-1969

St. John's Mercy Medical Center
St. Louis, Missouri
General Surgery
1969-1972

Louisiana State University Medical Center
New Orleans, Louisiana
Plastic and Reconstructive Surgery
1973-1974

Louisiana State University Medical Center
New Orleans, Louisiana
Chief Resident
Plastic and Reconstructive Surgery
1974-1975

St. John's Mercy Medical Center
St. Louis, Missouri
Chief Resident General Surgery
1975-1976

When redaction rules are changed, the redaction software can examine all existing files and identify where redaction is necessary.

Yes. Intellidact provides the ability for rule changes to be made and existing files to be examined for additional redactions.

Although Intellidact does provide this ability, we suggest you might be interested in saving yourself additional CPU cycles required to fully reprocessing existing OCR files as well as the extra storage for having to archive each images corresponding OCR file.

How we eliminate this unnecessary reprocessing to add any “oops didn’t think of it when we processed redactions” is Intellidact FutureProof™ technology. Our experts, most notably Mr. Frank Abagnale, has already thought of them for you, and when we process a document we can configure Intellidact to do so for every known combination of information that can be used to steal identity or compromise personal privacy. We then classify the data and save it in a consolidated format, providing the processing data base as a deliverable. There is no extra charge for this service or no significant increase in data storage.

As you have requested “one pass” OCR, Intellidact takes one pass savings a significant step forward and provides you with one pass redaction.

If after processing and during our five year warranty you discover a field that you need to add to your repository, CSI will reprocess all your images without charging you for either the rule writing or the re-processing. In eleven years and 4.5 billion images later we’ve had no one we’ve had to reprocess images for.

Out of the box FutureProof redaction data categories are:

• Addresses	• Marriage License Numbers
• Biometrics	• Minor Children Names & Ages
• Birth Certificate Numbers	• Maiden Names
• Cause of Death	• Optional Filer Numbers
• Checking Account Numbers	• Organization ID’s
• Credit Card Numbers	• Passport Numbers
• Customer Account Number	• Passwords
• Dates of Birth	• Patient Names
• Death Certificate Numbers	• Phone Numbers
• Debit Card Numbers	• PIN
• Driver License Numbers	• Professional Licenses
• Email Addresses	• Savings account numbers
• Employer ID / EIN	• Security Guard License Numbers
• FEIN	• Signatures
• Firearm Permit Numbers	• Social Security Numbers
• INS Numbers	• State ID’s
• Insurance Policy Numbers	• Tax ID Numbers
• Loan Account Numbers	• VIN

The final format of redacted images is a searchable pdf and meets ADA compliancy standards.

Yes. Intellidact can create Searchable PDF files as output. The Obfuscation feature (see page 4-18) can be used to provide for ADA compliance. For example, redacted text can be replaced with **REDACTED**, which will be sounded-out as such by a text reader for the blind.

If the solution requires an installation on each client machine, the software is updateable without physically touching each client.

Yes. As Intellidact is deployed to enterprises a considerable amount of time has gone into the architecture of deployment and configuration management. Intellidact ships with Octopus Deploy™ as an integrated deployment tool that prevents touching any clients and servers. Onsite installation is accomplished by clicking a single UI button and selection of your specific deployment environment (i.e. delivery, test/QA, Production, etc...) to minimize both time to deploy and eliminate risk of human mistake and manual configurations.

The system is interoperable with any standards-based content or document management system.

Intellidact is certified at native integration by the leading DMS systems.

For additional DMS systems that support modern architectures Intellidact provides a universal web service (UWS). UWS is a subscriber-based system that supports numerous callers via a single web service, and brokers submissions to the appropriate Intellidact backend system (one web service, many Intellidact backend systems).

For processing documents prior to DMS storage Intellidact provides native XML support for the Oasis ECF 4.0 / NIEM 3.0 standard.

The system is able to rapidly recognize or “fingerprint” document types based on previous examples.

Yes. Intellidact performs image classification based on rules initially established during a statistical sampling of images at the start of the project. As new images are processed, the classification rules continue to learn.

The system is able to extract and classify documents based on those recognized types.

Yes. Intellidact has native ability to automatically classify documents and apply different redactions to different document types if such is required.

In addition to document classification, several years ago we invented the ability for Intellidact to classify the types of data it locates such that privacy data items of interest but not statutorily requiring redaction can be processed and saved for later redactions (CSI “Future Proofing™”). This process once for all data items and save what they are has allowed us to provide redaction solutions on over 4 billion images and we’ve never had a customer have to change rules and reprocess all documents like other vendors solutions proffer due to their lack of ability to perform field level classification.

Example data field classification
Note data tags appear above located privacy information

CIRCUIT WARRANT TO ARREST
FILED
FELONY

STATE OF FLORIDA 2008 SEP 11 A 9:52
VS. DAVID R. ELLSPERMAN
CLERK CIRCUIT COURT
MARION COUNTY, FL

IN THE CIRCUIT COURT OF THE FIFTH JUDICIAL
CIRCUIT, MARION COUNTY, STATE OF FLORIDA

08-3800 CF-AZ
08-3800 CF-AZ
AGENCY 0081960
Hold CONTROL key and Click.

DOB: 08/11/1981 RACE: WHITE, SEX: MALE, SOCIAL: 348-72-0446 HEIGHT: 6'00", WEIGHT: 170, HAIR: BLACK, EYES: BLUE, ADDRESS: 1731 NE 30 ST OCALA, FL 34475 DRIVERS LICENSE NUMBER: S352-541-81-291-0

IN THE NAME OF THE STATE OF FLORIDA, TO ALL AND SINGULAR THE SHERIFFS OF FLORIDA, SPECIAL AGENTS OF THE FLORIDA DEPARTMENT OF LAW ENFORCEMENT AND FLORIDA STATE ATTORNEYS INVESTIGATORS;

NAME HEREAS, DETECTIVE KEVIN BRINSON, has made before me that in the county and state aforesaid, MARK ANTHONY SYDENSTRICKER (W/M, DOB: 08/11/1981, SSN: 348-72-0446) in the County of Marion and the State of Florida, on or about the 21ST day of May, in the year of Our Lord, two thousand eight:

COUNT I
CREDIT CARD FRAUD (F3)
817.61
BOND AMOUNT \$2,000.00

Did unlawfully and knowingly obtain money, goods or services, to-wit: US Currency, of a value of one hundred dollars (\$100.00) or more by fraudulent use of credit card or by unlawfully using a credit card three (3) or more times within a six (6) month period, to-wit: Visa debit card, number 4828536440011, issued to Anna Packer, without the consent of said cardholder, with the intent to defraud the said cardholder, the issuer, Wachovia Bank, or a person or organization providing the said money, goods or services, in violation of Florida Statute 817.61;

The offense(s) set forth in the forgoing warrant is/are contrary to the statute in such cases made and provided, and against the City of the State of Florida, attached hereto and made a part hereof by incorporation is Affidavit executed by DETECTIVE KEVIN BRINSON, Affiant herein.

THESE ARE, THEREFORE, to command you to arrest said MARK ANTHONY SYDENSTRICKER and bring him before me to be dealt with according to law.

SIC
Rhonda K. Weber
Affiant Personally Known to Notary Public

The system is able to read bar codes or QR codes inherently with no additional cost or modules.

Yes. Intellidact natively accommodates OCR-A/USASI-A, OCR-B, E-13B/MICR, F7B/ISO/IEC 7811, Handprint (ICR), Check Mark (OMR), and both **1D, 2D and QR barcodes** allowing Intellidact to recognize and **redact privacy information in plain sight but hiding within barcodes**.



The system has a powerful one-pass OCR engine that allows both the capture of metadata, indexing, classification and redaction information.

Recostar Pro and **Intellidact EyeSight™** are Intellidact’s character reading systems (aka “recognition engines”). As we contain features here very unique to CSI we provided additional explanation for your review.

CSI Intellidact has exclusive use of Recostar Pro and as such you will not find Recostar in any other response to your RFP. Recostar has been benchmarked to provide superior character recognition than either the Nuance or ABBYY technologies, with the IRS selecting **Recostar for the largest recognition project in US history, the United States census**.

Unlike other OCR/ICR engines, Recostar provides for both OCR and ICR interpretation of the image data, **and then a voting engine** evaluates on a character by character basis whether the data returned by the machine print engine (OCR) or handprint engine (ICR) is of higher confidence. Recostar then constructs words combining the best character results from either engine.

For details of how voting engines improve upon the OCR and ICR process, we have attached a white paper on technical details of such titled *Improving OCR/ICR Results with Expert Voting* in the appendix to our response.

In addition to OCR, ICR, and Voting, Recostar **provides for field specific “image enhancement”** prior to the OCR and ICR processing stages that is not possible within other recognition engines. This allows Intellidact to make automatic minute adjustments to enhance/adjust the image and address problems with image quality or orientation that may be affecting only a specific area of the image often prevalent in historical document projects. Other recognition engines only provide page specific image enhancements or manual setting adjustments that make such not of high value in large volume processing projects, especially those images whose original source was from microfilm conversions.

The system allows for configurable watermarking/stamping of selected documents.

Yes. Intellidact includes a workflow engine that allows for watermark/stamping of documents by document type or all. The watermark and document types it is to be applied to upon release is configured through Intellidact Web Administration UI.

The system is able to, from a single pass, output two or more redacted versions based on different rules.

Yes. Intellidact has the native capability to provide multiple redacted output documents (i.e. secure versions) from the processing of each input document in a single processing pass. Each secure version may contain different combinations of redaction fields. Such allows for the concept of “redaction security levels” where different users are provided with redacted documents that have different redactions on the same document based upon what they have been defined as being allowed to view or not view.

Redaction security levels are defined in the Intellidact Web Administration UI by creation of Redaction Security Profiles (“RSP”), one RSP exists for each group of users requiring different viewing security. Each RSP created specifies that Intellidact release processing produce an output document version redacting fields that are defined to be secured by that RSP.

For example: In the case of a defense attorney and a defendant, where the defense attorney is allowed to see victim’s name and address (un-redacted), and the defendant is not allowed to see the victim’s address. We will create two RSPs created, RSP_DATY and RSP_DEF with the only difference being that RSP_DEF will have in addition to what is common for redaction, the “victim address” included in its RSP definition.

The output results of such using a document name of PO Report:

- PO Report.TIF- Document output as a TIFF
- PO Report.PDF – Document output as a sPDF
- PO Report _R.TIF- Redacted TIFF (default version)
- PO Report _R.PDF – Redacted sPDF (default version)
- PO Report _RSP_DATY_R.TIF – Redacted TIFF (Defense attorney version)
- PO Report _RSP_DATY_R.PDF – Redacted sPDF (Defense attorney version)
- PO Report _RSP_DEF_R.TIF – Redacted TIFF (Defendant version)
- PO Report _RSP_DEF_R.PDF – Redacted sPDF (Defendant version)
- PO Report _index.xml – Indexed data xml
- PO Report _redact.xml – Redaction data xml
- BI42_Batch.xml – Batch xml

Example Redaction Security Profile definition

Profile Name	Active	Prefix for File Name	Suffix for File Name
A1	✓	A1_	_A1

Field Definition Name	Release Type	Release XML	Redaction Option
Social Security Number	Encrypted redactions	✓	Redaction
Bank Account Number	Burnt redactions	✓	Redaction
Credit Card Number	Encrypted redactions	✓	Redaction
Date of Birth	Encrypted redactions	✓	Obfuscation
Maiden Name	Encrypted redactions	✓	Redaction
Minor Name	Burnt redactions	✓	Redaction
Financial Account Number	No redactions	✓	Obfuscation
DEMO01	No redactions	✓	Redaction

The system provides a forensic audit trail of redactions or changes made to the document.

Yes. Intellidact maintains a complete forensic audit trail that starts with the version of the software that automatically processed the specific page down to the last time someone inspected the page, or modified redactions on the page. All audit information is available via our user interface or use of a web service API to allow you to access without requiring knowledge of Intellidact database structures.

Example audit of redaction activity on a page



Design Flaws

State any product design flaws, faults, or omissions of which you are aware. State the status of any solutions to these.

No design flaws, faults or omissions. We do however continue to improve the product as we have done for the past 11 years so expect more features and functionality with future generations of the product.

Ability to Satisfy Requirements of Administrative Order 19

The system must comply with all legal requirements of Administrative Order Number 19. Please describe any system deficiencies that do not comply and the plan for remediation of the deficiencies.

No deficiencies.

Assumptions

Clearly state any assumptions you made in preparing your proposal.

No assumptions. Using what was stated in the RFP and answers to the RFP Questions and answers to construct our response.

Other Information

Provide additional pertinent information not specifically addressed by this document, including features, documentation, and limitations.

We believe all pertinent information previously covered.

5. Cost Proposal

Certification

“I hereby certify that the prices included in this proposal are accurate and binding and that all costs are shown and accurately reflect my total proposal cost.”

Signed:

A handwritten signature in blue ink, appearing to read 'HS', is written over a faint, illegible stamp.

Henry Sal
President
Computing System Innovations

Pricing

There are two categories required for the cost proposal:

1. The cost to AOC for software and services to meet the first two project goals:
 - redaction of electronic documents currently stored in the central Contexte database;
 - redaction of documents when delivered to the AOC for storage in the Contexte repository as part of an electronic filing implementation;
2. The cost for individual courts should they desire to engage the vendor to meet the second two project goals:
 - a state contract that will allow courts to purchase the services of the vendor for redaction of images and electronic documents currently stored in local DMS repositories;
 - a state contract that will allow court users to purchase vendor software or services to be able to interactively redact documents as part of an historical back-file scanning project.

As the RFP has identified two distinct combinations of redaction processing (i.e. all documents either in an existing repository or as they are added to a repository, and redaction on demand as documents are being requested for public viewing) we are providing simplified statewide pricing to utilize for both.

The statewide pricing provided is by unit/image, allowing the AOC or county to select the exact license volume desired and provide the best unit price to all purchasers irrelevant of their individual size or license volume.

An Intellidact “single use” license is purchased for the processing of one image one time. An Intellidact “perpetual use” license is purchased one time for processing of images in perpetuity. Perpetual licenses have an additional charge of 18% software maintenance per year and single use licenses do not have a cost for software maintenance.

For AOC and County back file redaction projects it is recommended that a “single use” license provides the greatest cost savings to the State. For redaction on demand projects it is recommended that a “perpetual” license provides the greatest cost savings to the state.

By providing a single statewide unit price model each and every county gets the benefits of purchasing at the lowest unit cost irrespective of their document volumes, which traditionally have been lower volumes have higher unit pricing than higher volumes.

With that said, there are also several different options requests for processing:

- Intellidact redaction software installed at customer site with customer processing and validation
- Customer documents provided to CSI for automated processing at CSI with customer performing remote validation
- Customer documents provided for CSI for automated processing at CSI with CSI performing manual validation

Item	Description	Unit price	Total price
1	Intellidact single use license – per image cost (Customer processing and validation)	1.1 cent per image	Number of images times unit price
2	Intellidact perpetual license – per image cost (Customer processing and validation)	3.5 cents per image	Number of images times unit price + [yearly support price of 18% of license price]
3	Universal Web services per county	\$2,000	\$2,000
4	Universal Web services site license (all counties and AOC)	\$50,000	\$50,000
5	Remote installation, training, and project management (per onsite install)	\$3,500	\$3,500 plus any travel and living expenses if onsite presence requested
6	Intellidact single use license – per image cost (CSI processing and customer validation)	1.75 cents per image	Number of images times unit price
7	Intellidact single use license – per image cost (CSI processing and CSI validation)	2.4 cents per image	Number of images times unit price
8	Intellidact datacenter setup and project management per customer project	\$2,500	\$2,500
9	Intellidact development services (integration development if needed)	\$150/hour	Total number of hours times \$150
10	Intellidact Search [Optional]	\$12,000 per year per 4 CPU core node	\$12,000 x number of nodes

6. Appendix

- Sacramento County scoring sheet
- Case studies
- Intellidact Accuracy Methodology white paper
- Improving OCR and ICR Accuracy white paper
- Press releases
- Product data sheets

Sacramento County Redaction RFP Award Scoring

Total Evaluation Points by Vendor by Sub-Category												
CCR Redaction Project RFP 7236												
Selection Criteria	RFP Reference	Total Possible Points	Weight	ACS (Extract)	AmCAD	AtPac (Extract)	BMI	CSI	FNTI (Extract)	IKON	Mentis	Unsys
Previous Experience-Total Percentage		33	20%	18.18%		12.72%		20%	7.87%	9.90%	18.78%	
Total Score				30	0	21	0	33	13	15	31	0
Company Profile	T.2	6		6		6		6	4	6	4	
Successful Previous Experience	T.2, S.6.2	18		18		6		18	0	0	18	
Similar Industry	T.2, S.6.2											
Same Products Proposed	T.2, S.6.2											
Project Team Qualifications	T.2, S.6.2	9		6		9		9	9	9	9	
RFP Written Responses - Total Percentage		711	37.50%	13.92%	12.92%	13.81%	0.33%	26.58%	12.97%	13.29%	22.83%	11.23%
Total Score				264	245	262	6	504	246	252	433	213
Mandatory Req	T.6 A.L	522		180	165	180	6	351	180	180	318	126
Informational Req	T.6 A.L	144		48	44	48		118	48	48	80	56
Desirable Req	T.6 A.L	12		4	4	4		4	4	4	4	6
Cost Worksheet	T.8 A.I, S.1.11	18		18	18	18		18	6	6	18	12
Executive Summary RFP Responses	T.3	3		3	3	3		2	1	3	3	3
RFP Responses 1-6	T.4											
Layout of Proposal	S.4.2	3		3	3	3		3	1	3	3	3
Implementation Plan & Schedule	T.5	6		6	6	4		6	6	6	6	4
Project Manager Identified	T.5, S.6.3											
Project Plan	T.5, S.6.3											
Vendor Tasks	T.5, S.6.3											
County Tasks	T.5, S.6.3											
Hardware Requirements	S.6.5	3		2	2	2		2	0	2	1	3
Price/Value - Total Percentage		18	17.50%	11.66%		17.50%		11.66%	17.50%	5.83%	11.66%	
Total Score				12	0	18	0	12	18	6	12	0
Relative Ranking Score	A.I	18		12	0	18		12	18	6	12	
Sample Data - Total Percentage		18	10%	3.33%		3.33%		10%	3.33%	0	6.66%	
Total Score				6	0	6	0	18	6	0	12	0
Total Score (Accuracy of offsite processing)	S.1.5	18		6	6	6		18	6	0	12	
Presentation - Total Percentage		54	10%	8.15%		5.70%		9.62%	5%	4.62%	4.35%	
Total Score				44	0	31	0	52	27	25	23.5	0
Product Knowledge	S.4.9	18		18	12	12		18	3	6	12	
Spdd of complete process	S.4.9	6		6	4	4		4	4	4	4	
Ease of use	S.4.9	15		10	10	10		15	10	10	5	
Quality of sample (Accuracy of onsite processing)	S.4.9	15		10	5	5		15	10	5	2.5	
References - Total Percentage		30	5%	5%		0.83%		4.17%	0	0	5%	
Total Score				30	0	5	0	25	0	0	30	0
Ranking Score		15		15	5	5		15	0	0	15	
Score of Comments	T.7, A.E	15		15		0		10	0	0	15	
Total Percentage			100	60.25%	12.92%	53.95%	0.33%	82.05%	46.68%	32.84%	69.31%	11.23%
Total Score		864		386	245	343	6	644	310	298	541.5	213



HP and Computing System Innovations



Intellidact

Fast, accurate redaction technology for all your sensitive documents



Protecting sensitive data

You need the ability to provide public access to electronic documents. However, with identity theft and fraud skyrocketing, the challenge becomes finding the right solution to effectively protect sensitive information despite shrinking budgets, smaller staff and increasing regulatory pressures.

Solution at a glance

Intellidact: Automated Redaction Software

Intellidact delivers advanced redaction technology that can identify and remove (redact) sensitive fields of information from documents, whether archived or newly scanned. The system's character recognition engines can read both hand written and machine printed information, enabling your organization to process hundreds of thousands of documents rapidly and accurately, with little to no manual verification. Intellidact's patent-pending technology locates unstructured data anywhere in a document, "reading" and redacting whatever private information is specified such as social security, bank account, driver's license and, debit and credit card numbers. Highly intuitive, the system can extract and redact in one pass, saving significant processing time and streamlining workflow. To accommodate ever-changing legal and business requirements, Intellidact can "future proof" your investment by marking fields for future redaction, eliminating the need to reprocess the same documents. The system's 3D Redaction capabilities add a third dimension that incorporates advanced software analytics for even greater levels of accuracy.

Intellidact provides a cost-effective, high volume and high accuracy redaction solution with the least amount of manual verification in the industry. Now your staff can confidently and rapidly respond to information requests, knowing that private data is secure, and protected against fraud and identity theft.

Working together with HP

Silver HP business partners offer leading edge solutions that integrate with HP's wide portfolio of LaserJet imaging and printing products, and provide HP customers with an unparalleled breadth and depth of solution offerings around the world.

What if you could...

Easily and automatically protect sensitive information on public documents

Increase accuracy to 99.5% while virtually eliminating manual intervention

Enhance staff productivity and increase workflow

Confidently comply with new and future privacy legislative changes

Solution benefits

With HP and Intellidact you can:

- Redact sensitive information fields in any PDF, TIFF, GIF or Microsoft® Office file
- Increase accuracy and volume dramatically, while reducing manual intervention
- Respond quickly to legislative mandates without adding staff
- Handle extremely high document volumes while sustaining high-speed workflows
- Future proof with features that eliminate reprocessing when new legislation is enacted

For more information

As a full service provider, CSI delivers comprehensive solutions, services and support for the entire Intellidact suite of products. For more information or to set up a demonstration, contact: Victor Lee, Sales Executive at 407.598.1825. You can also visit www.hp.com/go/gsc or www.csisoft.com.



Intelligent Redaction

Intellidact enables users to protect privacy through automatic redaction while maintaining high-speed workflows as part of the normal document scanning and processing functions. Using unstructured data recognition, the system can find data on documents no matter where it's located. It also has the power to extract data from documents and create searchable data files or PDFs. With four advanced character recognition engines—machine, handprint, MICR and cursive script—Intellidact intelligently looks for specific types of data and uses powerful rule sets to rapidly locate and redact confidential information. The system does not alter the original scan but instead creates a redacted version that can be saved separately into the public image repository. Whether your organization is mandated to comply with today's increasingly complex privacy laws or you want to preserve your company's reputation against data security breaches, Intellidact is the solution of choice when you are entrusted to protect sensitive, personal and confidential data within the documents and records you maintain.

Building on the value of strong relationships

By working side by side with HP, we have all the resources, experience and knowledge we need to deliver customized solutions that meet your unique business requirements. For more than 50 years, HP has designed solutions that allow customers to actively anticipate change and then act on it. Together, we use future-focused technology and services to design solutions that produce lasting value and maximum results—helping you meet today challenges while preparing for tomorrow's.



SEMINOLE COUNTY CLERK OF COURTS

HP scanners, Kofax Capture and Intellidact software automate redaction process



Seminole County
Clerk of Courts

“Our HP scanners and automatic redaction system is saving our office many, many hours of staff time. It does an excellent job of identifying the right information to redact so that manual intervention is rarely necessary. I think we’re saving several days of work over the course of a month.”

—Shahid Khoja, system administrator, Seminole County Clerk of Courts, Sanford, Fla.

HP CUSTOMER CASE STUDY:

County record-keepers employ HP scanners, Kofax document capture software and CSI automatic redaction software to provide public document access while protecting personal privacy

INDUSTRY:
Public sector

OBJECTIVE:

Accurately and efficiently redact private data from publicly available documents

APPROACH:

The Seminole County Clerk of Courts in Florida has deployed a system that uses HP Scanjet N9120 Document Flatbed scanners, Kofax Capture software and CSI Intellidact® software to digitally capture and automatically redact documents

TECHNOLOGY IMPROVEMENTS:

- HP N9120 scanners provide optimum density and contrast to enable more accurate OCR and redaction postprocessing
- Autoreduction software intelligently identifies and reliably redacts private information

BUSINESS BENEFITS:

- Automated workflow supports greater document throughput with fewer staff devoted to document capture and processing
- Accurate redaction through automated software solutions efficiently protects information privacy

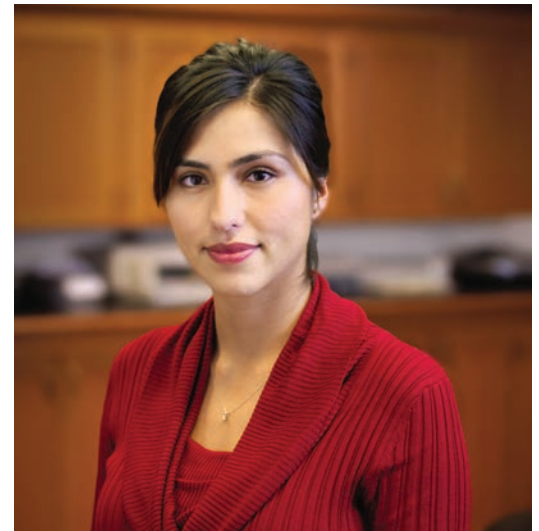

In the information age, governments provide the public with access to an unprecedented amount of information in the form of public documents. It’s a contemporary litmus test for an open society.

Balancing this out is the assurance of personal privacy. Public records often include personal information that individuals would prefer to keep confidential, including full legal names, addresses, social security numbers and more. Identity thieves don’t need to go dumpster diving anymore to find private personal data; all the information they need is in public documents.



The Seminole County Clerk of Courts in Florida is dealing with this dilemma by providing public access to records, but redacting personal information that the public doesn't need to know. To keep pace with the growing volume of such documents—more than 100 million pages last year—it has deployed HP scanners in combination with software that automatically redacts the sensitive information.

“The responsibility to both provide public access to records, and protect individual privacy, is becoming more and more challenging. Automated scanning and redaction technology is key to our being able to deliver on both promises, and to do so without increasing the cost of government.”

—Shahid Khoja, system administrator, Seminole County Clerk of Courts

“Our HP scanners and automatic redaction system is saving our office many, many hours of staff time,” notes Shahid Khoja, system administrator. “It does an excellent job of identifying the right information to redact so that manual intervention is rarely necessary.”

PROTECTING PRIVATE DATA IN PUBLIC RECORDS

The Seminole County Clerk of Courts acts as the central record-keeper for Seminole County, located in central Florida just northwest of Orlando. It handles documents relating to all court cases—civil, criminal, traffic and juvenile—as well as all land records, and more. The office employs 15 deputy clerks who work full-time scanning and processing the documents.

Because of privacy concerns, the office has been redacting sensitive information in its case documents for several years now. That includes social security numbers, maiden names, driver's license numbers, bank account numbers and the names of juveniles.

At first, documents requested for public review were manually redacted prior to release. “When someone came to the court house asking for a file, we would copy it and a supervisor would manually redact the sensitive information from the entire file,” notes Khoja. It was, predictably, both time-consuming and occasionally inaccurate. Though highly skilled at recognizing sensitive information, deputy clerks nonetheless are human, and humans make mistakes.

The clerk's office tried to automate redaction for one group of its legal records once before, but the technology proved unsatisfactory. More recently, the office decided to try again. It found that HP Scanjet N9120 Document Flatbed scanners, using Kofax Capture software paired with Intellidact® software from Computing System Innovations (CSI) for redaction, met all its requirements.

HP SCANNERS CENTRAL TO DOCUMENT SOLUTION

The HP Scanjet N9120 scanners are rated to scan up to 50 pages per minute with resolution up to 600 dpi, in document sizes up to 11 x 17 inches. “The speed is very important to us. We were looking for a scanner that could scale up with our workload and that would handle a variety of sizes and types of paper,” says Khoja. “The HP scanner meets all our requirements.”

All images are scanned using Kofax Capture software in 300 dpi resolution to comply with the state's legal requirements and saved in TIFF format. Its 200-page feeder enables the clerk's office to scan large batches of documents quickly, and ultrasonic double-feed detection signals the rare errors in paper handling so that a document can be re-scanned before the batch moves on for processing.

Khoja says the clerk's office was inclined toward HP based on past experience with HP support for the office's servers, printers and other HP hardware. “We have used HP products for all our mission-critical applications, and we get great support from HP. Our new HP scanners are proving every bit as reliable as our other HP systems.”

CUSTOMER SOLUTION AT A GLANCE

PRIMARY APPLICATIONS

Document scanning/redaction

PRIMARY SOFTWARE

- Kofax Capture
- CSI Intellidact®

PRIMARY HARDWARE

- HP Scanjet N9120 Document Flatbed Scanner



The Kofax Capture software paired with the HP scanners incorporates some redaction capability itself, but because it cannot read and redact handwritten material, the clerk's office needed more. Kofax introduced the clerk's office to CSI and its Intellidact software to enable more universal document recognition and redaction.

INTELLIGENT REDACTION

CSI software enables users to protect privacy through automatic redaction while maintaining high-speed workflows as part of normal document scanning and processing. Intellidact software utilizes unstructured data recognition. "That essentially means we can find data on documents no matter where it's located," explains Henry Sal, president of CSI. It also has the power to extract data from documents and create searchable data files or PDFs.

"The redaction technology provides added benefits to the customer. It saves on data entry costs and provides more consistent data to the database because the software is automating processes, eliminating human error," Sal continues.

The software incorporates four advanced character-recognition engines—for machine, handprint, MICR and cursive script. The software intelligently looks for handwriting related to keywords; some handwriting that follows "SSN" in a document, for example, is recognized as a social security number that must be redacted. The combined power of Intellidact's character-recognition engines and powerful rule sets enables it to rapidly locate and reliably redact confidential information.

Intellidact does not alter the original scan. Instead, it creates a redacted version of the original document that can be saved separately into the publicly available image repository.

Here's how the process works for documents related to the criminal case system: Documents from a given case are sent to the clerk's office, a case number is created, and documents are scanned using one of seven HP N9120 scanners and Kofax Capture software. Bar-coded batch separators are used to signal the beginning and end of multi-page documents.

Then the Intellidact software runs its autoreduction routine, creating a second set of electronic document files in which the fields slated for redaction are highlighted. These files are sent to employees who index the documents based on the case number and assign a code for the type of document. They also quickly review the redacted versions to ensure the redaction is accurate and complete.

"Our indexers have the option of manually redacting any additional information that they feel should be removed," Khoja notes. "But that's rarely necessary."

When the indexers are satisfied that the documents have been properly redacted, they release the document batch and it is sent to the office's Informix database. At that point, the redacted images can be accessed by the public and by employees of the Seminole County Courts. Unredacted scans of the same documents are also stored by the clerk, but in secure files that can't be accessed by the public.



**AUTOREDACTION SAVES TIME,
IMPROVES ACCURACY**

Sal says that, based on the experience of users throughout the United States, it takes three to seven seconds to redact a document using software, compared with a minute or more to do it manually. With the clerk's office redacting a million documents a year, automatic redaction is clearly saving the office staff time.

It's also improving accuracy. "Generally the software recognizes all of the material that needs to be redacted, and documents can be approved very quickly by the indexers," says Khoja.

"We found that an automated workflow solution incorporating HP Scanjet flatbed scanners, Kofax Capture software and Intellidact software from Computing System Innovations for redaction met all of our requirements for efficiently maintaining information privacy."

—Shahid Khoja, system administrator, Seminole County Clerk of Courts

Of course, the redaction software must accurately recognize and interpret document content in order to do its job. That means scan quality is more important than ever. The Scanjet N9120 Document Flatbed Scanner delivers high quality scans by automatically compensating for

documents that are on dark or colored paper to produce the optimum contrast for legibility, and by straightening scans if paper feeds through the scanner at an angle—a distinct possibility given the variety of sizes and shapes of documents received by the clerk.

"The quality of document scans from our HP scanners is just excellent," Khoja notes. "We're depending on that quality for this whole system to work."

The clerk's office is not yet taking advantage of the software's autodocketing/indexing or automatic data extraction features, but is expecting to do so in the future. The office is also likely to expand use of autoreduction to include civil court cases and possibly land documents.

"The responsibility to both provide public access to records, and protect individual privacy, is becoming more and more challenging," notes Khoja. "Automated scanning and redaction technology is key to our being able to deliver on both promises, and to do so without increasing the cost of government."

Share with colleagues



Contact the HP Reference2Win Program, 866-REF-3734 for more information

© 2011 Hewlett-Packard Development Company, L.P. The information contained herein is subject to change without notice. The only warranties for HP products and services are set forth in the express warranty statements accompanying such products and services. Nothing herein should be construed as constituting an additional warranty. HP shall not be liable for technical or editorial errors or omissions contained herein.

Intellidact is a registered trademark of Computing Systems Innovations Inc.

4AA3-3408ENW, February 2011



HIT PRINT



County Clerk's Office Helps Protect Citizens' Privacy

Distributed Image Capture Helps the Palm Beach County Clerk & Comptroller Achieve Compliance and Enhance Customer Service

When the state of Florida handed down a mandate requiring county clerks to remove personal data from public records, the Palm Beach County Clerk & Comptroller upgraded to a document imaging system that was truly ahead of its time.

Four years ahead of its time, to be exact.

The Palm Beach County Clerk & Comptroller's Office is an independent, constitutional governmental agency headquartered in West Palm Beach. At its head sits Clerk & Comptroller Sharon R. Bock, whose responsibilities include serving as the county's chief financial officer, auditor and treasurer, clerk of courts, county recorder and clerk of the board of county commissioners. The third largest of Florida's 67 clerk's offices, the agency serves a local population of 1.2 million citizens from seven locations, and online at www.mypalmbeachclerk.com. In 2007, the office served nearly 1 million walk-in customers and more than 1 million telephone customers.

With such varied functions and so many customers, the Clerk & Comptroller receives and processes millions of paper documents annually. These documents include "official records" such as mortgages, deeds, liens and marriage licenses and "court records" such as traffic citations, complaints and final judgments. Documents arrive from any number of sources by mail or messenger, or are presented in person.

"Our paper volume is tremendous," said Un Cha Kim, chief operating officer of the Clerk & Comptroller's Office. "We receive over 20 million pages per year."

A proponent of public records modernization, Clerk Bock has led the change to bring information to the county's citizens via the Internet. In addition to online services such as traffic ticket payment and forms preparation, the Clerk's Office maintains a Website where users can access digital images of official records and dockets of court cases.

State Mandate Calls for Data Redaction

To address privacy concerns and reduce identity theft, the Florida legislature recently passed a statute requiring county clerks to redact personally identifiable data from images of all public records by 2011. Redaction is a process whereby confidential information — such as Social Security numbers, bank account details and credit card numbers — is removed from, or concealed within, records. The Florida mandate applies to all public records filed with the Clerk & Comptroller's office, including those it provides on the Internet.

Considering the Clerk's quantity of archived records and document images, and the high volume of new documents it receives each year, compliance was not going to be an easy task. Palm Beach County courts file nearly half a million new cases annually, each with its own supporting documents. Unstructured documents abound. Some court records include hard-to-read documents such as handwritten notes. And the Clerk is required to retain some official records for decades, sometimes forever, as in the case of adoption documentation. Old documents such as these can be fragile, faded or otherwise damaged.

Personal Information, Off the Record

To contend with the state mandate, the office called on the services of longtime partner Computing System Innovations (CSI), a systems integrator headquartered in Orlando. CSI had overseen the implementation of the Clerk's records management system five years before and possessed the needed expertise to comply with the statute without disrupting the existing records retention system.

For automated redaction, the agency selected IntelliDact, CSI's proprietary redaction software. IntelliDact uses optical character recognition (OCR) to identify personal data in digital images, including bank account



information and credit card numbers. The software searches the unstructured information in images for keywords, such as “credit card” or “SSN,” and marks any neighboring data it suspects of being confidential for redaction. Besides redaction, IntelliDact automatically docketed document images. Auto-docketing extracts identifying information — such as the case number or names of parties of interest — from images and enters it into a database, saving the Clerk’s Office the trouble and expense of keying that data manually.

The accuracy of any redaction solution depends in large part on the readability of the document images. With that in mind, the Clerk’s Office and CSI gave careful consideration to scanner and software selection. They ultimately opted for a combination of Sidekick and Tr_per scanners from BÖWE BELL + HOWELL Scanners (BBH) and Kofax Ascent Capture software.

With CSI’s guidance, the Clerk’s Office closely examined its business processes and eventually settled on a distributed scanning system that would capture and automatically redact documents at their points of entry. The office placed the scanners in strategic locations in an effort to maximize efficiencies, with low-volume production Tr_per scanners at sites with higher paper volumes (e.g., bulk mail processing) and compact, entry-level Sidekick scanners at sites with lower paper volumes (e.g., counters serving walk-in customers) or where desk space is limited. In all, the Clerk’s Office has deployed approximately 100 Sidekick scanners and 20 Tr_per scanners. Besides the scanners’ speed, versatility and ease-of-use, the agency appreciated that Tr_per and Sidekick come bundled with Kofax VirtualReScan® (VRS) image enhancement software. VRS automatically checks and corrects document images for alignment, brightness, contrast and image clarity. This step is critical in preparing the images for OCR and redaction.

Imaging + Redaction = Productivity + Compliance

Palm Beach County has completed redaction of its official records — both back-files and all new incoming documents — which number more than 40 million pages. On the court records side, due to the sheer volume of documents, the Clerk’s Office is introducing automated redaction in a phased plan, one court at a time. The system has gone live for the county’s traffic/misdemeanor, probate and circuit civil courts, where all new records are imaged and redacted, and then saved in a database. The Circuit Civil department, for instance, scans and redacts approximately 400,000 pages per month. Fortunately, BBH’s durable scanners handle such document volume with ease.

One benefit of the distributed scanning system is it allows data to be entered into the Clerk’s system faster, rather than waiting for documents to be transported physically to a central scanning location. A traffic ticket scanned in the Clerk’s South County branch, for example, is redacted automatically, uploaded to a centralized server, and validated and processed at the West Palm Beach headquarters.

“It used to take several days for a document received at the courthouse to be entered into our system as a case on record,” Kim said. “But today any document that enters these courts is imaged quickly and automatically redacted for personal information. This has proved to be an effective way of protecting our citizens’ privacy while reducing manual data entry.”

The Clerk’s Office will not image and redact all archived court records — an estimated one billion pages — because many of them are decades old and never need to be accessed. Instead, employees only scan and redact court records that are specifically requested and retrieved from archive. These documents can be up to 35 years old, and the paper may be very delicate. Fortunately, staff can rely on the Tr_per 3200 model scanners, which have a flatbed scanning option for exception documents, fragile documents and bound pages.

“In addition to an auto-feeder, the scanners have a glass bed, which allows us to scan irregular documents without damaging them,” said Karen Heidtman, director of legal records for the Clerk & Comptroller’s Office. “This comes in handy in our criminal departments where we might receive spiral-bound documents or pages torn from a composition book.”

Office departments that have implemented imaging and automated redaction have seen significant productivity benefits and tangible savings. The traffic department, for instance, now scans and automatically redacts about 6,500 citations per week. Previously, the department had about eight full-time staff and 15 temporary staff who entered data from citations. Two or three workers scanned the citations for archiving. Despite the manpower, there was a three-week scanning backlog. Yet within three weeks of CSI’s IntelliDact system implementation, the staff had learned to operate the easy-to-use document scanners, eliminated the backlog and done away with the need for temporary workers.

“The system saves time and resources, and increases our redaction accuracy,” Clerk Sharon Bock said. “It also gives our staff a well deserved sense of empowerment. Workers once labeled ‘data entry people’ are now trained, tech-savvy associates.”

With auto-docketing working smoothly for six court systems, the Clerk & Comptroller expects to complete rollouts soon to the remaining courts: circuit criminal, county civil, family and juvenile. According to COO Kim, the Clerk & Comptroller’s Office’s innovative imaging system will significantly increase productivity across the organization — not to mention achieve compliance nearly four years before the state’s 2011 deadline.

Case Study

Government



Marion County Prevents Identity Theft With the Help of Kofax Ascent and VRS Technology

Overview

The Marion County Clerk of the Circuit Court in Ocala, Fla. maintains all county court files and records, ranging from mortgages and deeds to court judgments and traffic tickets. Recently, the agency implemented an automated redaction solution designed to remove such sensitive information as Social Security numbers, bank account numbers, and credit and debit card numbers from public records. Using the Kofax Ascent platform and Kofax VRS (VirtualReScan) technology, the Marion County Clerk of the Circuit Court was able to leverage the capabilities of redaction software developed by Kofax Certified Solution Provider Computing System Innovations (CSI) and comply with a Florida privacy mandate in less than seven weeks.

The Challenge

Under Florida's current public records law, citizens are responsible for requesting that their private information be removed (or redacted) from public documents to minimize the potential for identity theft. But as of January 1, 2007, such responsibility will no longer rest on individuals' shoulders. Rather, after this date, clerks of the court must automatically redact Social Security numbers and similar data from public records upon receipt, thereby ensuring that all sensitive information is kept confidential in line with Florida's open-record laws.

“Ascent played a major role in enabling the Marion County Clerk's office to process such a large volume of documents in a short period of time, as well as to achieve compliance with the mandate ahead of schedule and before any other counties could do so.”

To comply with the mandate, the Marion County Clerk decided to begin redacting data from existing documents long before the 2007 deadline. At the time, the county already had more than 7 million official records dating back to 1965 that were electronically stored in an image archive solution developed by NewVisions Systems Corp. “We decided that implementing a software solution would be the best way to handle the redaction process,” says Jack Suess, chief deputy clerk of administrative services for the Marion County Clerk of the Circuit Court. The clerk's office chose IntelliDact, a redaction solution developed by system integrator CSI, but the agency still needed an efficient means of extracting information from documents and delivering it to the redaction application. It also required a solution to enhance the quality of images scanned from documents.

The Solution

Only Kofax' Ascent Platform and Kofax VRS technology were considered as potential complements to IntelliDact. “The experts at CSI told us that for maximum efficiency, we had to have a solution that would execute information capture, processing and delivery alike,” Suess explains. “Ascent was the only application with this essential capability.”

The decision to address image enhancement by deploying Kofax VRS proved equally easy to make. “In order to properly complete redaction, you need the best possible digital image,” Suess notes. “However, many paper records are hard to read because they are old



KOFAX[®]
A DICOM GROUP COMPANY



and deteriorating, are printed on colored paper, or are carbon copies of original documents, such as traffic tickets for example.

As we learned from CSI, only Kofax VRS gets around these obstacles by making scanning more efficient and enhances the quality of scanned images.” With the solution, paper documents are scanned, then automatically sharpened, cleaned, and perfected by Kofax VRS before Ascent collects and delivers them to IntelliDact. IntelliDact uses unstructured data recognition technology to search documents for sensitive information and automatically slate it for redaction. The process is based on business rules provided by the Marion County Clerk’s office. For instance, the business rules may prompt the software to search for keywords such as “Social Security Number” or “SSN,” then look to the left, right, above, or below to locate that number and mark it for redaction.

“Kofax VRS was equally instrumental in paving the way for success: It helped the agency to achieve a 99.7% redaction accuracy rating from its redaction solution. No matter how good a data recognition technology is, it will fail if the information on the front end is unreadable; as the old saying goes, garbage in, garbage out.”

Results

Once all beta tests of the system were complete, CSI copied the Marion County Clerk’s entire database onto independent servers and began the redaction process on all 7 million records in its back file of images. The job took just six weeks and four days, making Marion County the first county in Florida to successfully comply with the redaction mandate.

Ascent played a major role in enabling the Marion County Clerk’s office to process such a large volume of documents in a short period of time, as well as to achieve compliance with the mandate ahead of schedule and before any other counties could do so. “Without the seamless collection, transformation and delivery of critical information to IntelliDact provided by the Kofax technology, it would have been difficult to move documents through so quickly,” says Suess.

“While our statistics indicated only 8% to 10% of our records would actually contain information that would require redaction, we had no way of knowing which documents they would be, so we had no choice but to evaluate every document for possible redaction.”

Suess adds that Kofax VRS was equally instrumental in paving the way for success: It helped the agency to achieve a 99.7% redaction accuracy rating from its redaction solution. “No matter how good a data recognition technology is, it will fail if the information on the front end is unreadable; as the old saying goes, ‘garbage in, garbage out,’” he observes.

By delivering unmatched image quality, Kofax VRS made it easier for the redaction software to look for and accurately identify sensitive information. These capabilities also saved time by reducing the need to rescan documents, as well as by eliminating such document preparation tasks as orienting pages in the same direction before scanning and permitting users to scan black-and-white and color documents in one batch rather than two separate ones.

Both Kofax Ascent and Kofax VRS technology continue to be an integral part of the Marion County Clerk’s redaction solution. New records are now redacted as they are scanned and hard, unredacted copies of all documents are maintained in the files for those citizens that require them. “The delivery to IntelliDact by Ascent, and the ability of Kofax VRS to facilitate accurate optical character recognition for records that contain sensitive information, mean compliance with the mandate is a no-brainer for us,” Suess concluded.

For more detailed product information, visit us at: www.kofax.com, or call us today at: (949) 727-1733.



Kofax Image Products, Inc.
16245 Laguna Canyon Rd.
Irvine, CA 92618
Tel: 949-727-1733
Fax: 949-727-3144
info@kofax.com
www.kofax.com

Computing System Innovations
791 Piedmont Wekiwa Rd.
Apopka, FL 32703
Tel: 407-598-1800
Fax: 407-598-1879
info@csisoft.com
www.csisoft.com

Intellidact Accuracy Methodology

Introduction

When determining redaction accuracy methodology it is important that accuracy be measured across all processed documents. Several redaction vendors advertise the accuracy of their products using only the number of manual changes made to images the software presents for validation. This methodology does not take into consideration redaction errors that happen but are never presented for manual validation (these most often occur on images containing handprint or cursive script that the vendors OCR failed to identify privacy information on). Another redaction vendor attempts to market their products accuracy versus Intellidact stating that our accuracy is incorrect as we do not look at every image when computing accuracy. Needless to say Intellidact's accuracy is superior and not produced by smoke and mirror calculations but by hard work in creating unique software technologies and processes that allow us to deliver redacted images that exceed other redaction solution capabilities.

Following is an explanation on our methodology, the different measures of accuracy, how such may be calculated accurately for large repositories of images, and the unique Intellidact processes that are employed to provide the highest accuracy in the industry with the least amount of manual validation. Intellidact accuracy processes have been deployed and proven across 2 billion records, and as scored by customers the results several times more accurate than other redaction solutions.

200% Inspection

In order to conduct accuracy testing that is both measurable as well as precise Intellidact creates statistically correct "quality control" document sets from your existing repository at various stages of redaction processing. This is performed by random document selection using all document types and across all the years of documents in your repository. Such provides a manageable subset of documents, or a mini version of your repository that is used for accuracy certification processing. Quality control document sets can range from tens of thousands to tens of millions of documents the actual quantity based upon the size of your repository and the desired processing accuracy.¹

Quality control document sets are then processed with Intellidact with each and every image meticulously reviewed, modified as required, and certified as accurate by two different CSI redaction experts. The same software provided to you, IntelliValidate, is used during their manual validation process to assist in catching privacy information missed by simple human eye inspection. All corrections performed to achieve perfect redaction accuracy are automatically stored in Intellidact's forensic auditing database and used to calculate and report on processing accuracy.

¹ Statistical sample size calculations are outside the scope of this document. For such information please contact your Intellidact consultant who will assist you in locating and reviewing reference materials for your calculations.

Manual Validation

CSI employs a full time validation staff to provide end to end quality control for all processing and validation. To assist in the validation process Intellidact classifies images into one of four categories. The categories are color coded as red, yellow, green, and gray to easily differentiate images during their inspection stage. Red signifies mandatory inspection of a document type as it was expected to contain privacy information but none was found; Yellow is for suggested inspection as complex algorithms were invoked to inspect the image (i.e. such as cursive script); Green is for images that are undistinguished aside from having highly confident redactions, and Gray is for undistinguished images not having redactions. At all times, administrators have the ability to specify which images they wish staff to validate and Intellidact automatically enforces such during validation. For high volume back file production processing each and every image that is in Intellidact's red, yellow, and green queues are manually inspected by CSI subject matter experts, and images in the gray queue that are below an acceptable quality level for recognition are inspected as well.

OCR Limitations

To accurately process documents that contain handprint, cursive script, or are of poor quality unlike other solutions Intellidact does not rely upon optical character recognition software to identify and isolate such. Attempting to retrofit OCR technology for such results in false identification, increased validation volume, and missed redactions. Instead, Intellidact includes unique computerized vision technology, Intellidact EyeSight[®], to accurately and automatically flag these documents for human review. Redaction solutions without this capability require manual inspection of each and every image to ensure privacy information is not missed.

Example EyeSight[®] Cursive script detection

In witness whereof the Undersigned have hereunto set their hands and seals, this 27th day of December 2005.

Kelly A. Thompson
Kelly Ann Thompson Esq

Before the Clerk of the Fairfax County Circuit Court on this 27th day of December 2005.

The foregoing BOND was subscribed, sworn to and acknowledged by:
Kelly Ann Thompson Esq
the obligor(s) therein, and ordered to be recorded as provided by law.

Teste: John D. Eley, Clerk

By: [Signature]
Deputy Clerk

Book 8 2005/12/27/0000 section 110 Case No. 05-11000000

12/27/2005

Document vs. Image Centric

To accurately validate documents it is important that all pages of a document are validated as a collection rather than as distinct individual pages. Document centric validation is the only method that provides accurate review and correct redaction of information contained within a document. As privacy information may be initially identified on a page by a keyword or label, subsequent document pages may contain the privacy information absent the keyword or label. It is common for documents to have privacy information identified on a page as “social security #: **123-45-6789**”, and then within other pages have the number appear by itself without being identified. It is also common to have the original privacy information embedded in additional text such as “99-**123456789**-AZ”. Unless your redaction solution provides for document centric validation, users performing manual validation will have no idea if redaction of the text “**123456789**” is an over redaction mistake or a correct redaction. Intellidact of course provides for document centric processing as well as validation.

Validation Passes

To catch and correct for any errors of automated software processing various redaction solutions propose (or require) review of all images processed. Some vendors even suggest two manual passes be performed to catch human mistakes that may be introduced during the first manual pass, or to find redactions that were missed during the first pass review. Such processing is often termed “OCR+1” and “OCR+2”, with the “+1” and the “+2” indicating the number of human validation passes performed. Due to Intellidact’s advanced image processing technologies it is rare that an entire repository requires OCR+1 or OCR+2 validation to achieve accuracy that exceeds 99.5%. However CSI staff and processes exist to provide such based upon customer project requirements.

The Missing Dimension

Traditional redaction processing using automated software and manual review of documents is a two dimensional business process. Software first finds items to redact and then human’s inspection is used to make sure the software has not made mistakes, with additional humans being used to make sure the initial humans did not make any mistakes. Unfortunately humans do make mistakes!

To solve the problem of human mistakes in validation processing Intellidact does not rely upon additions of manual effort to catch and correct mistakes. Intellidact provides the missing third dimension to redaction processing by having software automatically check user changes across the entire document to ensure they have been correctly and consistently applied. Intellidact 3D™ processing identifies and corrects user errors introduced when validating a document by providing an additional and error free validation pass.

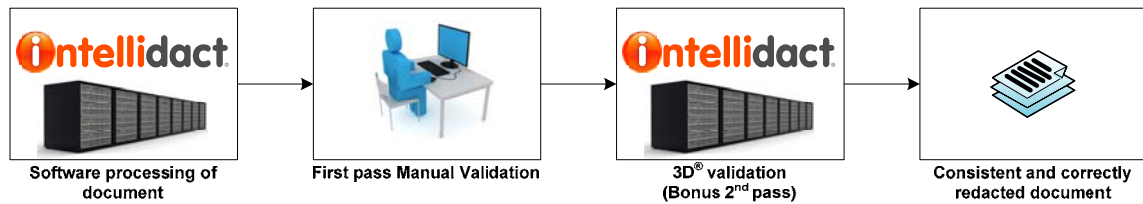

Validation Management

To assist in the assignment and tracking of manual validation efforts, Intellidact software provides a variety of necessary validation staff management functions. Documents may be automatically routed based upon the type of document or the type of data present to specific subject matter experts insuring that specific expertise is directed to the appropriate documents or data. Users in training, or new to the process, may be set so that all or a percentage of their validated documents are sent to a supervisor for review prior to being released for use. Validation document management provides numerous functions that allow you to tailor and track all aspects of manual validation processing to provide the highest possible accuracy results.

Accuracy Computation

After manual validation of quality control sets or the entire repository, accuracy computations can be performed.

Accuracy may be computed on a document, page, or field level basis. Intellidact provides the ability to compute accuracy for whatever your standard is.

To clarify the differences in definition of the above levels, let's use the following example:

- There is one document
- There are three pages in the document
- Each page has four fields that should be redacted
- Two of the fields from one of the pages were missed

Using our example, the document accuracy level is 0%, we had one document and we redacted the document incorrectly. Document Accuracy Percentage = $100 - ((\text{Documents with errors} / \text{Total number processed documents}) \times 100)$.

Using our example, the page level accuracy is 66%, we had three pages we redacted one incorrectly. Page Accuracy Percentage = $100 - ((\text{Pages with errors} / \text{Total number of processed Pages}) \times 100)$.

Using our example, the field level accuracy is 83%, we had twelve fields and we redacted two incorrectly. Field Accuracy Percentage = $100 - ((\text{Total field errors} / \text{Total processed fields}) \times 100)$.

The majority of Intellidact customers calculate accuracy on a page level basis as this allows them to also associate a level of validation performance with accuracy as well (i.e. 6,000 pages a day and 3 pages with errors). Some vendors state that page level accuracy is not correct as if

a page contains two fields that are not redacted correctly this can expose privacy information on two different individuals and should be counted as two errors. This is certainly correct however what this describes is not “field level accuracy”. This is “unique person” accuracy and in order to calculate this one would have to determine if errors found (across all pages processed) pertained to one individual or many. We believe a better investment of time would be to improve your redaction technology to not miss than to determine if information missed identifies one person or several.

For whatever accuracy level you desire to track, Intellidact provides the highest levels of accuracy with the least amount of validation work required to achieve such.

Statistical Subsets

A forewarning on accuracy computations is that if your repository is large (in the tens if not hundreds of millions of images) accurate manual accuracy calculation is itself suspect due to the sheer volume of data to inspect to determine what should have been redacted. In other words, you can only know how “wrong” you are by first knowing how “right” you were supposed to be. We have yet to find a customer that has the staff, the time, or the desire to accurately inspect tens if not hundreds of millions of records, so a simpler yet production proven solution is needed to handle computation of accuracy on large image volumes.

This large repository accuracy problem is solved by using statistically correct subsets of documents, reducing the number of images for inspection to a manageable quantity. Common randomized statistical sampling allows a manageable yet representative set of documents from all document types from all the years of data to be produced and processed in accuracy calculations, removing the problem with calculating the “how right” you should be number required to compute accuracy. Intellidact processing provides for multiple random statistical samples to be produced and scored at any stage of Intellidact processing.

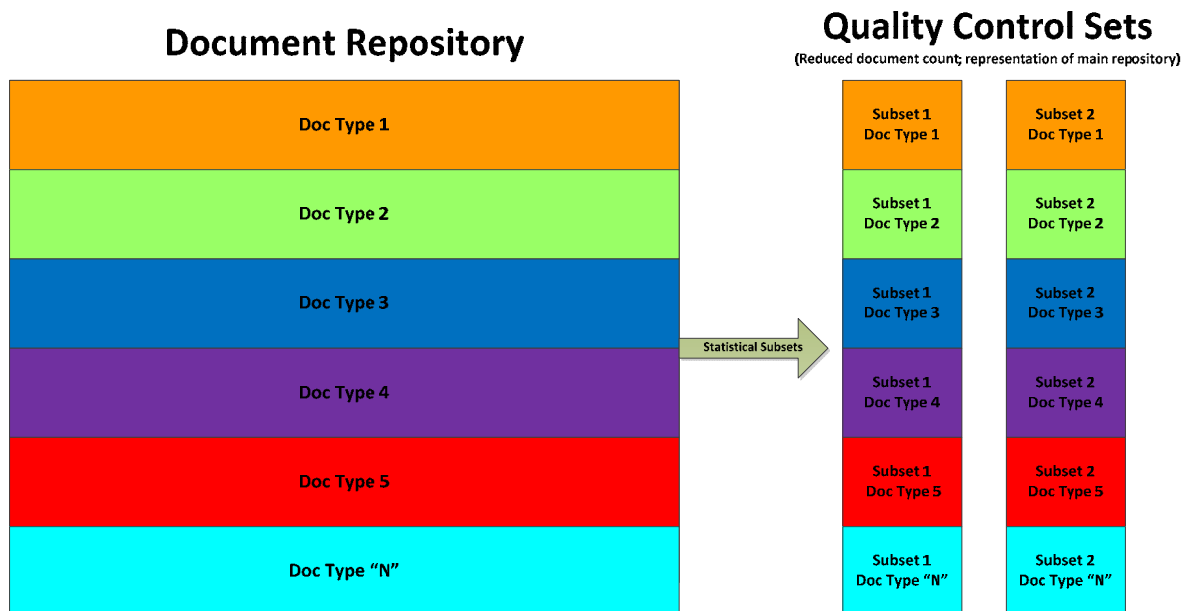

Absolute Assurance

Within the Intellidact process, redaction accuracy is certified a minimum of three times during a back file redaction project. The first occurrence is prior production processing and is used to determine that the existing rules provide results that exceed the contracted for accuracy rates. The second occurrence is upon completion of processing by CSI, and the third occurrence is with CSI assistance upon your review and audit of returned images. In addition to the minimum checks, customers are able to spot check accuracy and create as many quality control sets of images and accuracy checks that satisfy their comfort level.

Accuracy Reporting

Intellidact provides several mechanisms for review of calculated accuracy. Standard accuracy reports are shipped with each Intellidact installation and provide accuracy data down to the individual field level for each document as well as user performing validation. In addition to accuracy statistics, user performance statistics are also provided. Accuracy reports are capable of being run from Intellidact's web interface. Real time data is available from within the Validation Document Management interface.

We are certain of our unparalleled accuracy and Intellidact processing is guaranteed to be greater than 99.5% accuracy and includes a five year warranty on all processed image results. Intellidact's contractually guaranteed accuracy both under redactions as well as over redactions are counted as an error.

Intellidact has yet to lose an accuracy competition when benchmarked by customers against other redaction software vendors. Intellidact has won national redaction RFP's with the Intellidact process being the only solution that had 100% perfect accuracy scores in both offsite and onsite redaction processing. Customers have benchmarked Intellidact's accuracy to be 3 to 7 times greater than other vendors making claims of superior accuracy.

Improving OCR and ICR Accuracy Through Expert Voting

A White Paper

Presented by
Michael Breithaupt
Océ Document Technologies



791 Piedmont-Wekiwa Road
Apopka, FL 32703
Tel: (407) 598-1800
Fax: (407) 598-1879
Email: info@csisoft.com
Web: <http://www.csisoft.com>

Background

OCR (Optical Character Recognition) analyzes the shape of a bitmapped character and assigns a value to it. Different OCR products use differing methodologies usually based on a system of template matching or a mathematical analysis (consisting of feature analysis and feature extraction) as their baseline methodology. These analyses usually produce a range of possible results, so they are supplemented by post analysis validations which support the most likely result followed by the possible alternatives. Each possible character is supported by a likelihood percentage. It's an iterative process within an engine with analysis and check performed multiple times – sometimes as many as 10 within one engine to derive the most likely result.

Simple Fonts give High Accuracy

Most of today's OCR software can produce highly accurate results with well-formed laser or good quality machine printed text. This is particularly true with simple fonted 10-16 point fixed text and fixed character spacing on a plain background. However variable widths, proportional fonts, kerning, large sized text or exotic fonts will reduce accuracy and handprinted characters pose even larger challenges.

Differences between Full Text OCR and Forms Processing

Full text OCR is designed to convert a page of similar machine printed textual elements interrupted by photographs or diagrams, often formatted into two or more columns. The software needs to understand and decode this formatting as well as identify and capture the fonts used so as to enable easy editing. Legal conversion systems which need to understand the formatting of a case would be an example of this. Forms processing OCR is designed purely to capture transactional data from a form in an ASCII format typically to update a back-end computer system.

Forms Processing poses Challenges

In forms processing the challenges are greater. Data on forms can be created from carbon or carbonless forms, the printer may be a dot matrix, the original scanned forms may have been a fax, the background of the form may interfere with the foreground. Fields may not have dictionary entries to look up. Some fields may be created with either constrained handprint or worse, with unconstrained handprint. Sometimes a field may have mixed data types and frequently the field may contain either machine print or handprint which varies from form to form.

Accuracy Statistics and the Problem of Substitutions

While everyone wants accurate conversion, accuracy is a difficult concept. Some people define the accuracy rate as the percentage of all characters output as "recognized" by an OCR engine regardless whether the character has been correctly recognized or not. In CSI IntelliDact's world, the accuracy rate contains all the characters output by an OCR engine which have been recognized *correctly*. We know the correct characters, because we analyze this against a pre-known 'truth file'. This is a different approach from that of many other vendors who simply provide a percentage of those characters which the engine thinks are right. Thus with IntelliDact, the characters which have been output AND have been wrongly recognized are defined as errors or substitutions. As the engine also outputs characters which are flagged as low-confidence characters, a third category is the 'defined rejection rate'. Together, the three categories rates add up to 100%. One of the parameters available from a good OCR engine is the acceptance threshold, which allows the user to manipulate the substitution over the rejection rates. Generally speaking, a low acceptance threshold returns more "recognized" characters and contains more errors while a high acceptance threshold will do the opposite. So if the acceptance threshold is set too low, the engine will accept a very high percentage of characters and may include some characters which it thinks are correct, but which are wrong. These are known as substitutions and represent the most expensive errors to correct. On the other side, setting the acceptance threshold too high results in more rejected characters. Even though most of these rejected characters may have been recognized correctly, they need to be verified in a very labor-intensive post-processing step. Eliminating substitutions at a low rejection rate should be the true goal of a good OCR engine.

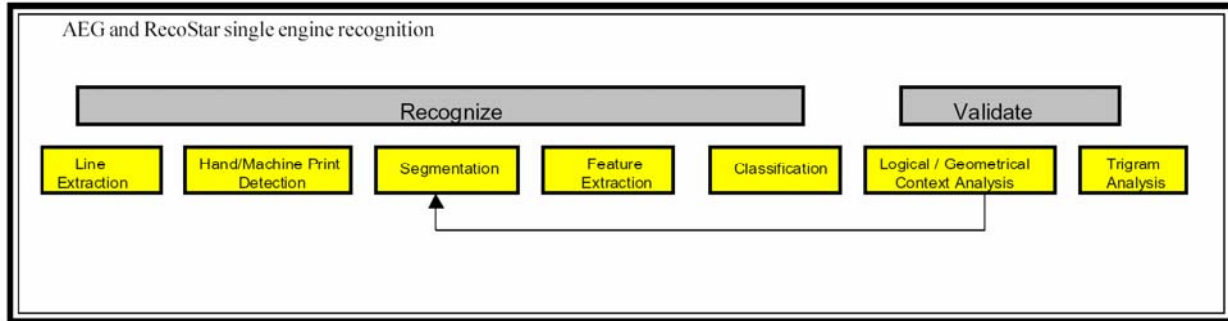

Voting Eliminates Errors and Improves Accuracy Rates

Voting takes the output from two or more recognition engines and compares the results, voting on the most likely. Voting is often cited as a method to try to improve the recognition accuracy from difficult types of images, however this is inaccurate. Voting is designed to eliminate errors and/or increase accuracy percentages at the same time. The preference in an OCR application of whether to get less errors at the same *accuracy* level, or higher accuracy at the same *error* level is controlled by various switches within the OCR engine. All OCR engines produce more than one result – and assign likelihood percentages to each result. Voting takes the recognition results from multiple engines and compares them – in some cases eliminating an engine, in others combining them to improve the results. In forms processing applications and in handprint applications, voting can be remarkably attractive.

The Basic Building Blocks of OCR

Recognition

The OCR recognition process consists of two major steps: extract and recognize the characters and then prove that the result is within its given context. If it does not pass its validation, then try the next best alternative until there is a high likelihood of accurate conversion. Within the recognition phase there are four main steps: Line Find, Character Segmentation, Feature Extraction, and Classification.

Line Extraction

In the case of forms processing, the identification of multi-line field blocks such as name and address or tables is critical.

For each block, the first step is to group all data elements (areas of connecting pixels) within the context of baselines (see illustration) so that the following steps are sure that they are dealing with complete characters. In the case of IntelliDact this is achieved through finding imaginary baselines and the rotation angle of the line. Although this may be difficult with handprint due to its up-and-down nature, once identified the baselines can be used to remove data elements (noise) pixels that fall outside them, improving segmentation and recognition.

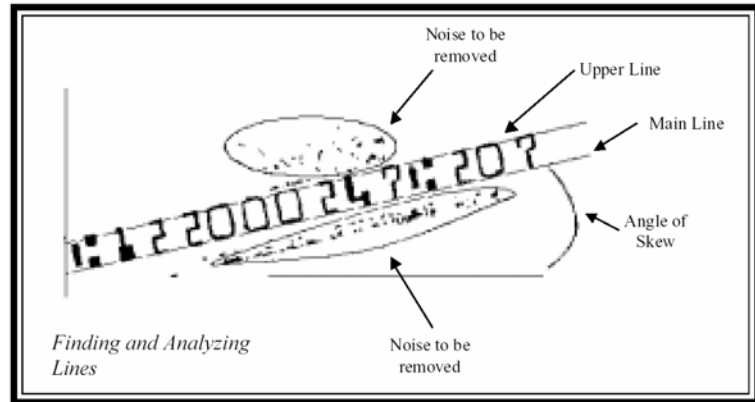

Hand/Machine Print Detection

The varying distance of characters from the baselines and the varying character heights tells the software whether the characters are machine print or handprint, since handprint tends to go up and down whereas machine print tends to be level. If the algorithm cannot unequivocally decide whether a field is hand or machine print IntelliDact recognizes the field through the machine and hand print classifier and then decide at the very end which result will be output.

Character Segmentation

Segmentation is the process of separating the characters. There are completely different segmentation algorithms for machine print and for hand print, and machine print algorithms vary for variable vs. fixed fonts. The first step is to determine the type of segmentation to perform. Is it:

- Fixed pitch characters? Such as in HELLO where each character has the same spacing
- Variable pitch? Such as in HEIGHT where the spacing varies depending on the characters
- Don't know?

If the algorithm cannot determine as to whether the field has a fixed or a variable font, IntelliDact performs the segmentation for both type of fonts, and decides at the very end which result will be used for further processing.

In the case of fixed pitch segmentation this is easy. It is more difficult with variable pitch fonts and most difficult with handprint. For example consider the word *DRIVE* as scanned here. It looks fairly straight forward. But the letter 'v' overlaps with the letter 'e'. All character elements are stored as run-length-coded (RLC) objects, which means each isolated data element can be moved, removed or logically connected with another RLC object to form a character. Initially the IntelliDact looks at a vertical gap between RLC objects or follow any "white path" between RLC objects to determine all RLC objects belonging to a character. Therefore in the word DRIVE above it might find 7 RLC objects –two from the D (circle and vertical bar), two from the R (vertical bar separated from the rest of the character) and one from I, V and E respectively. It then uses a histogram distribution of the

pixels to make the determination of where the most likely break in characters is or which RLC object belongs to which character. This is then subsequently classified, with logical and geometric context (as defined later) used to determine the right break or cut of the segmentation process. For example as v and e overlap the segmentation process would propose two alternative segmentations: 1) v and e as one character, 2) v and e as separate characters. Both proposals will be classified and validated. In our example, the result of the combined character v and e will have a low confidence character as a result, while the separated v and e will have good results with high confidence levels.

Feature Extraction

Feature extraction is the first step in classifying a character shape. AEG and RecoStar use fundamentally different approaches to analyzing the features of a character shape to perform this task. The difference in methodology is the foundation of a successful voting system as it compensates for the weakness of each engine while it combines the strength of all the engines involved.

The principal ideas of feature extraction are: (a) all features have to be complete; two different characters have to be clearly differentiated solely based on the features describing them; and (b) features have to be steady. For example, if a character shape is insignificantly distorted by some noise, the features describing the character should also just change negligibly.

In the AEG product the scanned character is normalized within a 16x16 matrix array, set to a common width and finally an artificial 16 bit depth (over 16,000 shades) grayscale is applied to each character to better analyze the shape.

The RecoStar product works somewhat differently, slicing the topography of the character every 15 degrees (giving 12 cuts) and looking at the shape to build a series of histograms determining the numbers of intersecting lines (similar to tomography in the medical arena). The data is used then for further mathematical analysis – a method also known as “Winkelschnittanalyse” WSA.

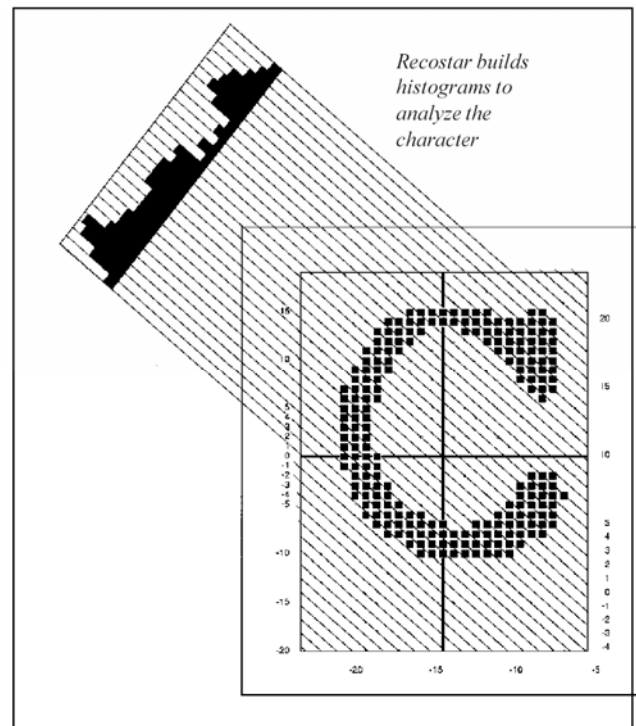

Classification

To unambiguously recognize a shape of character two requirements are fundamental: (a) the ability to differentiate characters of different shapes and (b) similar character shapes need to be classified as the same class of characters.

For these reasons IntelliDact recognition engines train on 10,000 to 30,000 different possible shapes for each character, e.g. 10 digits (one digit is one character class) can be broken down into more than 25 different classes of shapes. For example take the number 4. Let's consider 4 different possible shapes for the number 4:



These may be labeled 4-1; 4-2; 4-3 and 4-4. When



the system finds a  it might decide that this has a 95% chance of being type 4-1 as it shares the most commonality with this class of shape. The more classes of shapes are defined in a classifier the more robust the recognition of different hand writing styles due to regional, ethnic and age influences.

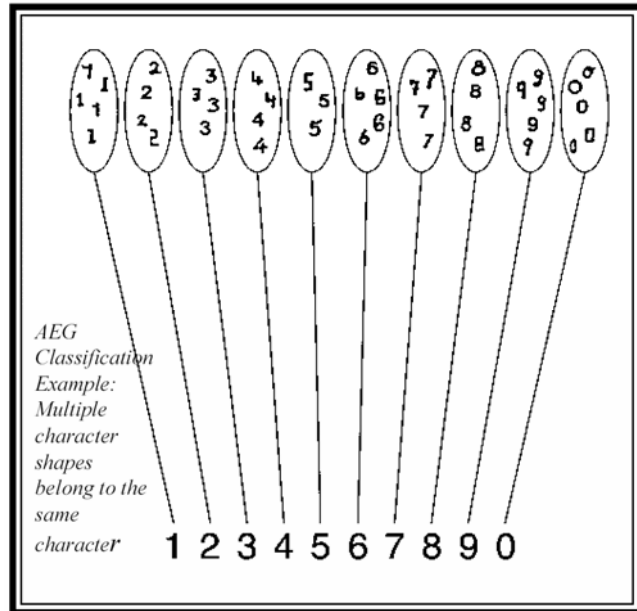

RecoStar has trained a series of base line classifiers which contain 2 shapes to cover all eventualities. For example AB, AC, AD etc., then BC, BD etc. If for example you send an  to the first classifier which determines that it is NOT a B, then B is eliminated with the next check being an AC. This provides a high level of confidence in finding the correct character class and possible alternatives.

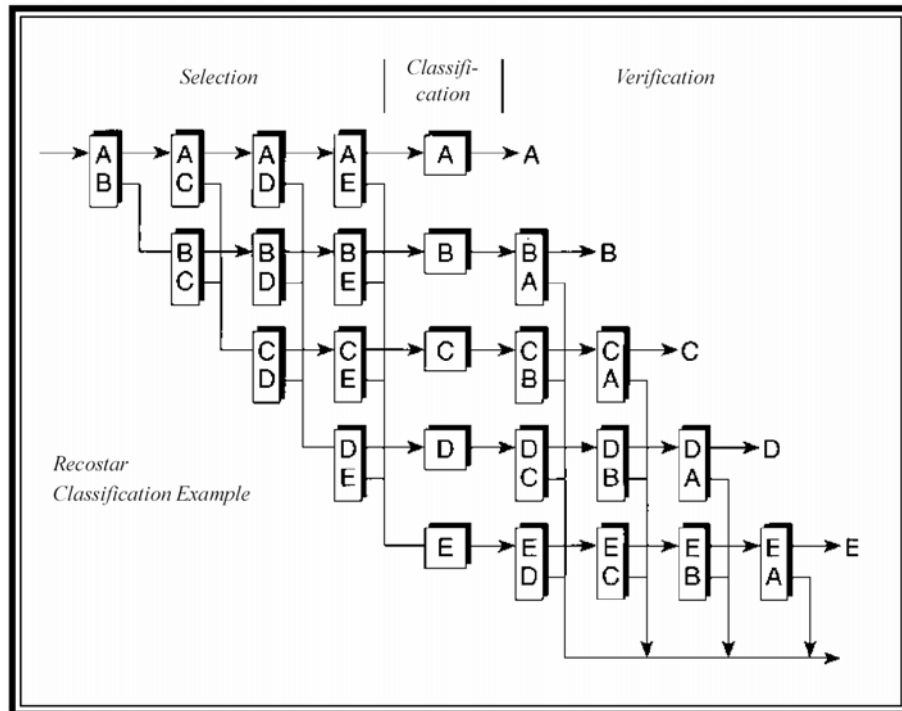

Validation or Proving the Accuracy

The context of the field helps to narrow down multiple choices of the OCR engine, i.e. it eliminates the ambiguity of certain characters (e.g. zero vs. “O”). Context can be defined by User (formal context) or can be automatically implied through an expert system (geometric and logical context) which analyzes the data recognized. All three context analysis tools work together hand in hand and comprise hundreds of rules packed into an expert system.

Logical Context

“Logical context” usually applies only in alphanumeric fields. The main task of logical context is to determine whether a group of characters (a group is defined by all characters between spaces or other delimiters like commas and dots) is a word (alphabetic only like MONUMENT), a number (digits only like 12500) or a “mixed” word (alphas and digits like WIN98). Consider the “O” in MONUMENT. Once “logical context” concludes this group of characters must be a “word” the character “O” loses its ambiguity and the also possible recognition result “0” (zero) will be eliminated. Logical context is also used to determine whether a character is being recognized as lower or upper case. This only applies to characters whose lower and upper case have the same shape (S vs. s, O vs. o, C vs. c) or the shape of a lower case character may be confused with the shape of an upper case character (I vs. 1). This kind of ambiguity may be resolved by applying general spelling rules. “Logical context” also uses “geometric context” to obtain further conclusions.

Geometric Context

To understand “geometric context” consider the word *Angel*. As an alphanumeric field the character *g* in this field may get a 55% confidence result of being a G and a 45% confidence factor of being a 9. In the case of IntelliDact, geometric context looks at the upper, medium, main base and lower baselines of a word as shown at left to determine whether each is an Alphabetic or Numeric character. In this case, if it was a 9, then it would fall between the upper and main baselines, but a G would fall between the medium and lower baselines. In this case logical context, in conjunction with geometric context, concludes that the field is alphabetic, the 9 disappears from the result list and the confidence level for G will be elevated. Geometric context can also give the engine a clue as to whether the character is upper or lower case. For recognizing amounts geometric context is heavily used to determine “1” and “,” as the hand printed shapes of these characters very often look the same.

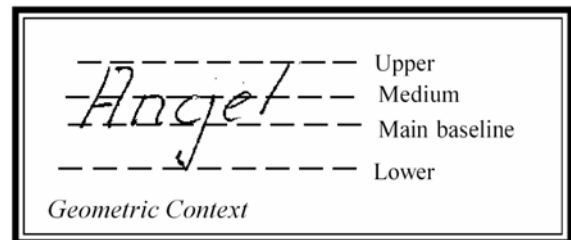

Formal Context

“Formal Context” checks on the result based on user-defined edit patterns such as NN-NN-NN for a date field.

Trigram Analysis

In the case of alphabetic information, three adjoining characters are analyzed in a process known as “Trigram Analysis”, which utilizes a language dependent set of tables to decide on the acceptability of the three characters. So for example, the letters MZD cannot appear in an English language word, so if the primary selection produces these characters the engine will try the next most likely combination.

Dictionary Lookup

The completed fields are compared to defined dictionaries which can be individually set up for each field with the entire phrase; a partial match; or just the alphabetic portion of a field which is useful for street addresses. But not all spellings of a word may have been included so partial matches to the dictionary will adjust the 'confidence' factor accordingly.

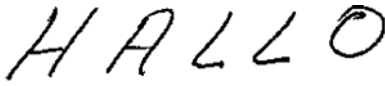
The following handprinted text:  spells the word HELLO the German way. The dictionary will not find the entry, but in the AEG and CGK solutions it will find the closest entry and know that there is one character incorrect and adjust the confidence accordingly.

What influences the results of a single engine?

The difficulty of Character Recognition can be classified based on the following criteria:

1. **Handprint** is more difficult to recognize than machine print
2. **In machine print**, dot matrix or computer line printer produced characters are more difficult than laser printed or typewritten. Carbon varies but NCR paper can be faded and very difficult
3. **Alphabetic Characters** are more difficult than numeric and alpha/numeric is more difficult than alphabetic.
4. **Unconstrained** or variable pitch fonts are more difficult than fixed fonts
5. **Lower case** is more difficult than upper case

Voting for machine print and handprint

Voting, using the results of more than one OCR engine, can substantially help results on the harder and hardest types of characters to recognize. Today's processor power allows the software to be run many times – in fact in many cases the IntelliDact engines have gone through 10 iterations in order to interpret just one character. It has been shown as preferable in the case of fixed and variable fonts, to run both processes and determine the field confidence from looking at both results.

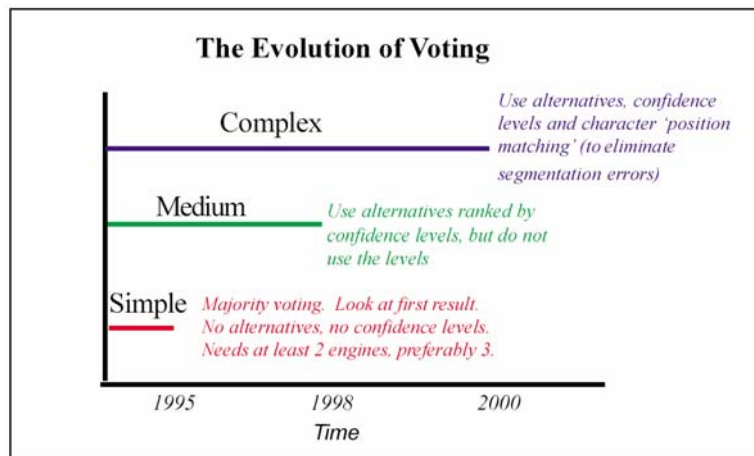

How voting works

Voting leverages from using the answers from more than one OCR engine to increase accuracy. It has evolved over the last few years from simply using two or three separate engines with majority voting to leveraging from an understanding of the internal processes of each engine. To appreciate this it is useful to review the different voting techniques in use today.

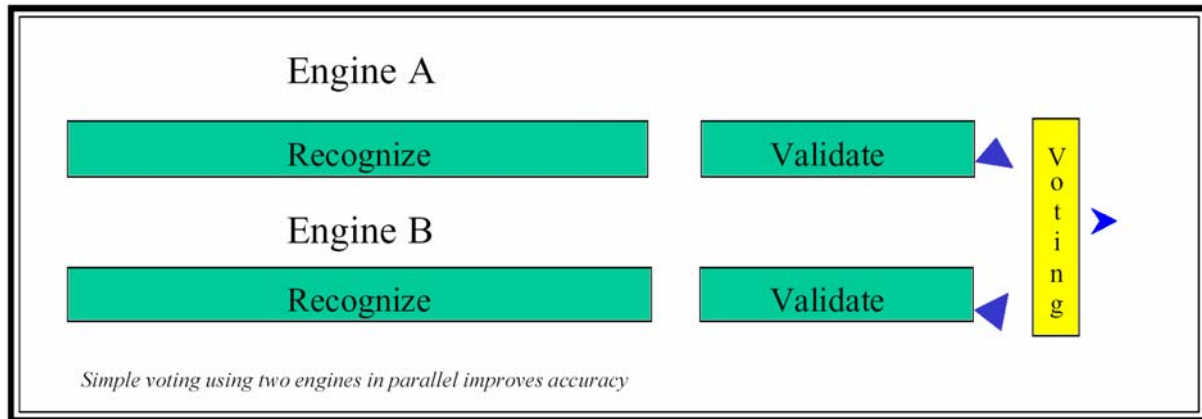

Simple Voting

A simple voting algorithm will determine that **H** is the character based on the majority ranking alone and not on the confidence factors. It needs at least two engines to work, but three engines produce better results. Depending on how many engines the system runs, the likelihood can be adjusted accordingly. It is a simple and effective way for manufacturers of forms processing to reduce errors, but it is possible to further improve performance by leveraging from the confidence.

Use of Confidence Levels

The next level of voting leverages from the confidence levels reported by the OCR engines. In this case you do not need more than two engines, as the system has a lot more information to work from. However, to make confidence levels work, the vendor of the voting system must first identify commonality by normalizing the confidence levels of the various engines from each manufacturer.

The best way to do this is to run a huge test deck of predefined characters, comparing the results and storing ‘credibility’ adjustment factors. The normalization process can then classify the engines in a fairly simple way on the basis of the numbers of substitutions and the rejections found as shown in the graph.

This has been shown to decrease inaccurate conversions, but it is essentially static. Because the vendor has no internal control over the internal processes of the defined engines, he is unable to run a process modifying and optimizing the results.

Consider the single line address below:

12500 E. MONUMENT DRIVE

- Engine 1 – the RecoStar engine – interpreted this as 1251#0 E. HONUMENT DRIVE
- Engine 2 – the AEG engine – interpreted it as 12500 #. MONUMEN-, DRIV##
- The voting engine –RecoStar Pro interpreted it *correctly* as 12500 E. MONUMENT DRIVE

There are three typical OCR problems identified in this example.

- **Bad Segmentation** – as when the RecoStar engine wrongly segmented the two zeroes and when the AEG engine wrongly segmented the V and E in DRIVE.
- **Poor Recognition** – which is shown by the # symbol, which indicates too low a confidence level or the confidence level of the first and second choice are too close to make a decision.
- **Substitution** – as when the RecoStar engine converted the M in MONUMENT to an H.

As an address line we were unable to tell the classifier whether the field was alphabetic or numeric, so each engine was looking for both character types. Clearly both engines individually had difficulty with the numbers as well as the T at the end of MONUMENT. The AEG engine also had trouble with the overlapping V and E at the end of DRIVE. But the voting engine eliminated the problems.

To understand why, we must look more closely at each engine’s interpretation. Both engines can classify their confidence between 0 for lowest and 255 for highest.

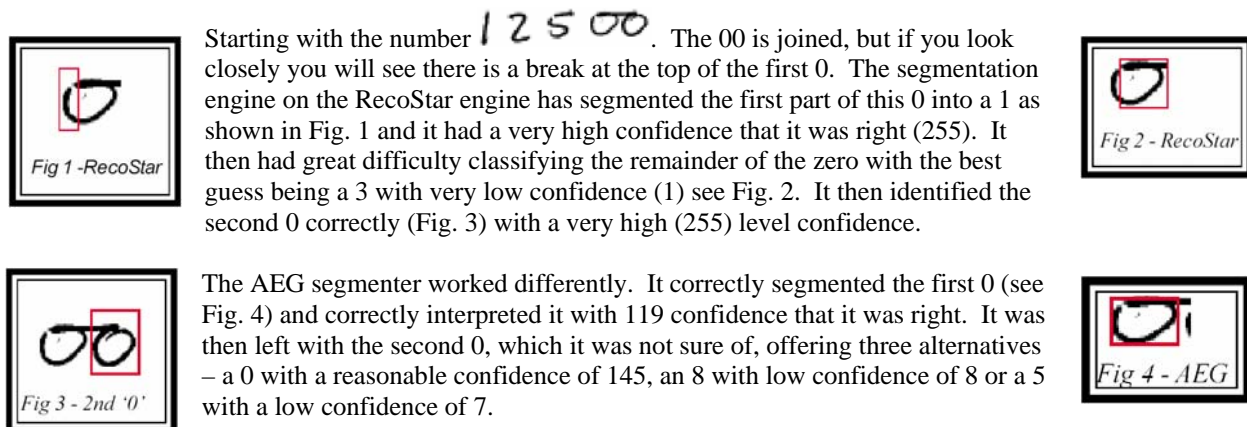

Note that the confidence factors are not percentages, they just represent the confidence that the engine has in each particular choice.

The M in Monument was a substitution wrongly interpreted by the RecoStar engine as an H (low confidence 65) with an M alternative as confidence 44. The AEG engine had a 185 confidence that it was an M with no alternatives.

Then we get to the E, which was correctly interpreted by the RecoStar engine with a very high confidence of 255. But the AEG result was not clear. It came up with an E with confidence of 31, an 8 with a confidence of 31 and an F with a confidence of 22.

The  also produced a different result with the AEG engine separating out the top of the T from the bottom, coming up with a dash (213 confidence) and a very confident comma (255).



Lastly the V and E in DRIVE caused differences in result. The RecoStar engine confidently and correctly decided that the characters were V and E (confidence 255 in each case). But AEG was not so sure. It cut the top of the V (see Fig. 5) and produced a 213 confidence that its choice was correct. This left it with a problem as shown in Fig. 6. It decided that this strange character might be a B – confidence 41, or an E – confidence 26, or possibly a Z – confidence 25.

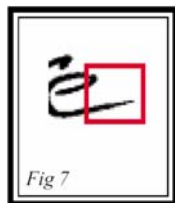

It then was left with yet another small set of pixels (see Fig. 7) which it tried to resolve. But it was not very happy with any of the alternatives. It decided that this might be an I (confidence 38), an S (confidence 34) or an L (confidence 29).

So how did the RecoStar Professional voting engine resolve this into the correct interpretation of:
12500 E. MONUMENT DRIVE

First the voting engine corrected the segmentation (see Fig. 8). The first zero in the house number then got resolved as a 0 (zero) with a confidence of 225. Although the RecoStar engine had a high confidence of the first part being a 1, this got outvoted because the confidence level of character following the 1 is very low and does not match the geometric position of the high confidence character as recognized by the AEG engine. In this case the results of RecoStar are not considered at all.

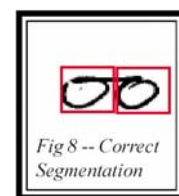

The second 0 got voted as a zero (confidence 248) or conceivably an 8 (confidence 5) or 5 (confidence 4).

Second, the E got resolved fairly simply as the RecoStar engine was confident and the AEG had it in its choice, albeit not first.

The substitution of the H instead of the M was resolved by the voting engine as an M (confidence 118) or an H (confidence 34).

In the case of the T, RecoStar Professional uses the internal location coordinates of the characters. So although it thought that the shape of characters might conform to a *dash* and a *comma*, this seems unlikely when voting on the result, as the top of the T was on the upper baseline with the lower part between the medium and the main baseline (see Page 6). A dash would typically be between the medium baseline and the main baseline, while a comma would typically fall between the main baseline and the lower baseline. As the surrounding boxes of both the dash and the comma of the AEG engine match the geometric location of RecoStar's T, a segmentation problem had been indicated to the voting engine and so it chose the T result over the less plausible dash/comma. One could argue that the segmentation problem should not have happened in the first place, but it also demonstrates that the voting algorithm is capable of ruling out certain incapacibilities in either of the two engines. Likewise in the case of the V and E, the segmentation problem got solved through comparing the confidence levels and the matching positions of the characters.

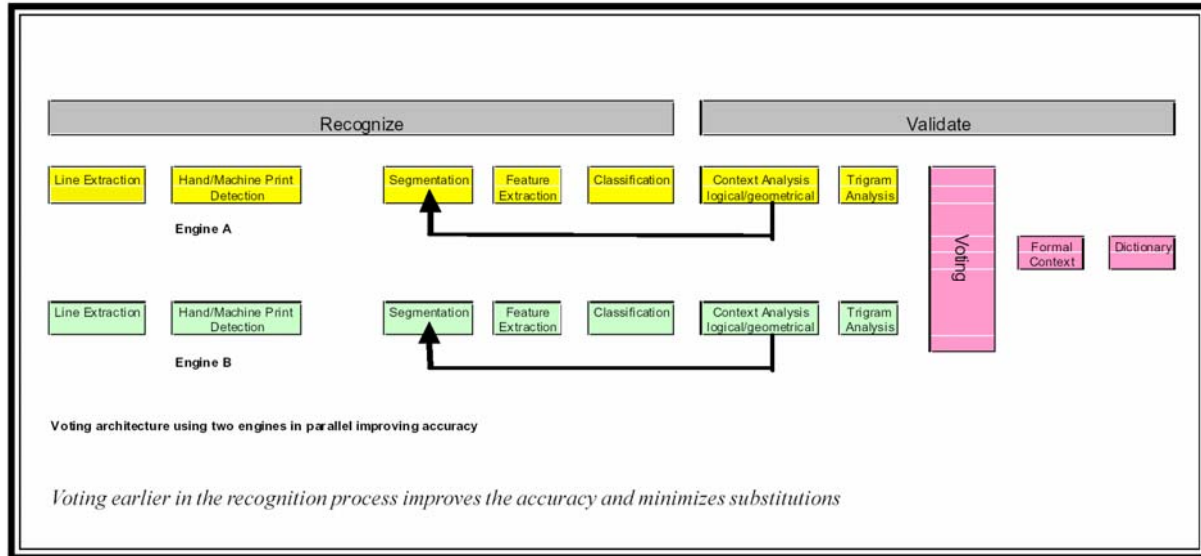

As a result of this type of internal voting, segmentation problems, which are the most costly to identify and fix, are nearly eliminated.

Voting systems, such as the one implemented by forms processing vendors, reduce expensive errors. If the voting engine has access to the internal OCR processes, it can make the fine adjustments in its iterative process that are needed to reduce substitutions on the most problematic characters. This type of internal voting substantially improves the value of voting as can be easily seen in the following examples.

Results of using RecoStar Voting with Real Life Examples

As a higher level of accuracy is sought with less substitutions, the numbers of rejected characters will increase. The charts below compare the single AEG and RecoStar products with the voting engine “RecoStar Professional”. As can be clearly seen, the number of errors is consistently substantially less when using the RecoStar Professional than with either of the single engines.

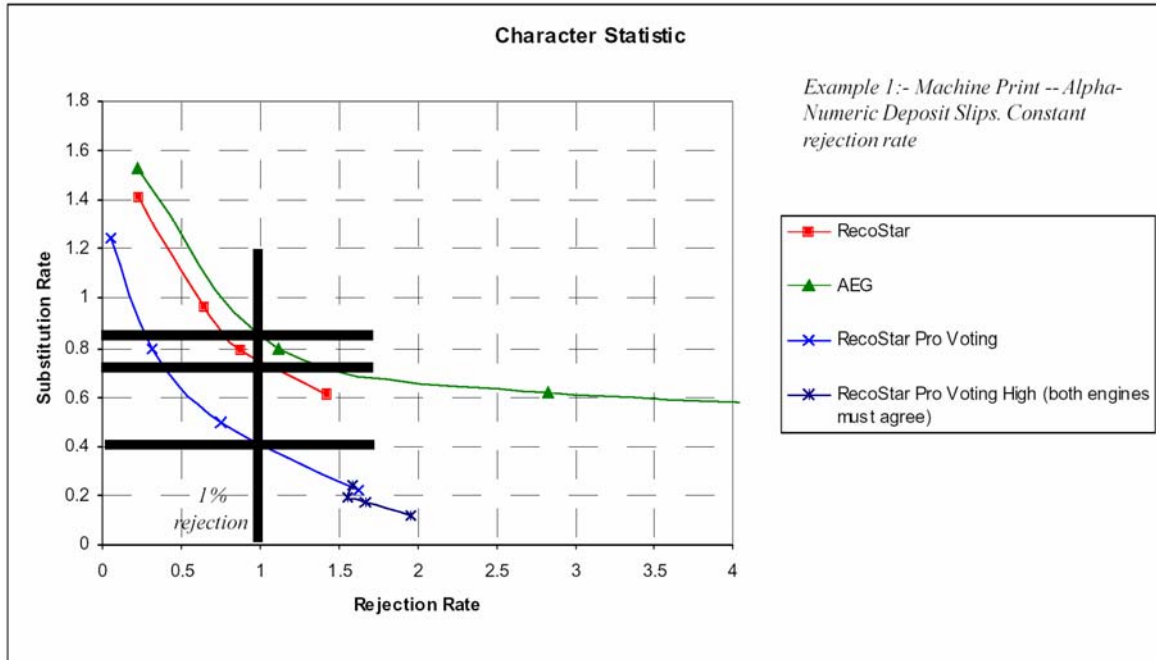

With a rejection rate of 1%, the single AEG engine creates 0.85% substitutions and the RecoStar engine creates 0.75% substitutions, but the voting RecoStar Pro Voting engine creates only 0.4% substitutions.

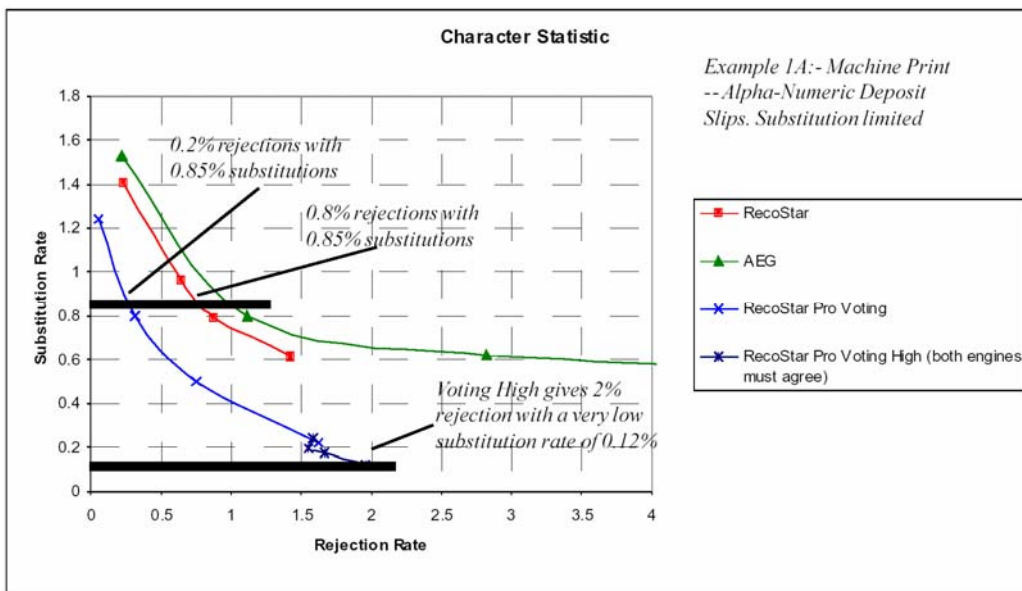

Alternatively, with .85% substitutions, the single AEG engine rejects 1%, the RecoStar engine rejects 0.8%, while the Voting RecoStar Pro engine rejects 0.2%. For important fields, the RecoStar Pro engine can be set to agree on both engines. In this case substitutions are nearly eliminated (0.12%), but more characters are rejected (2%).

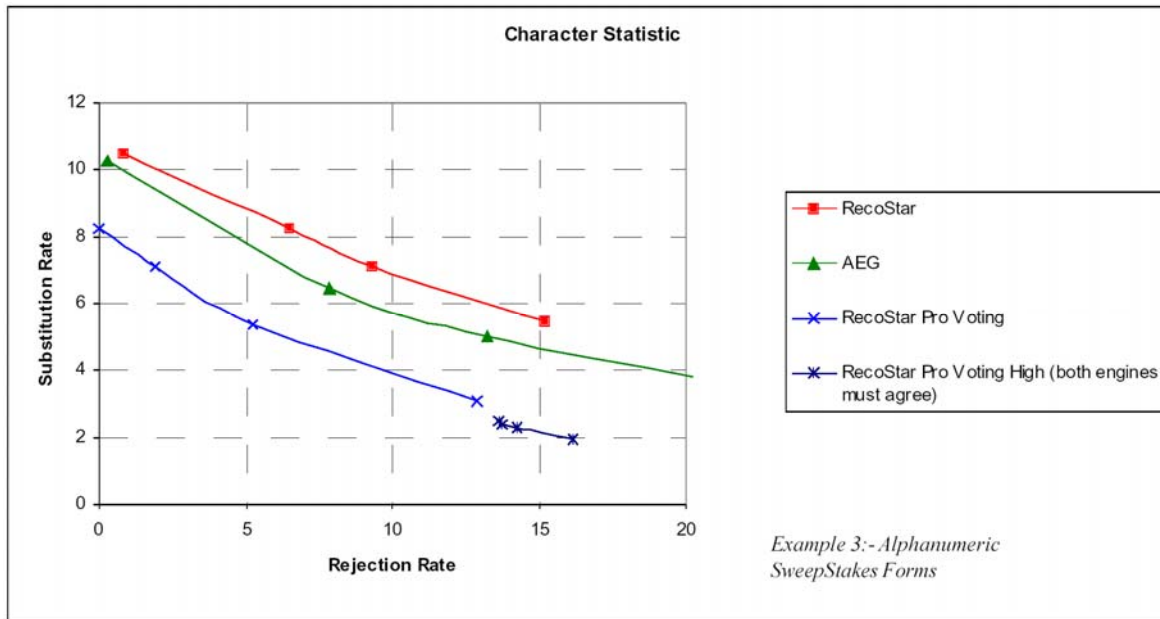
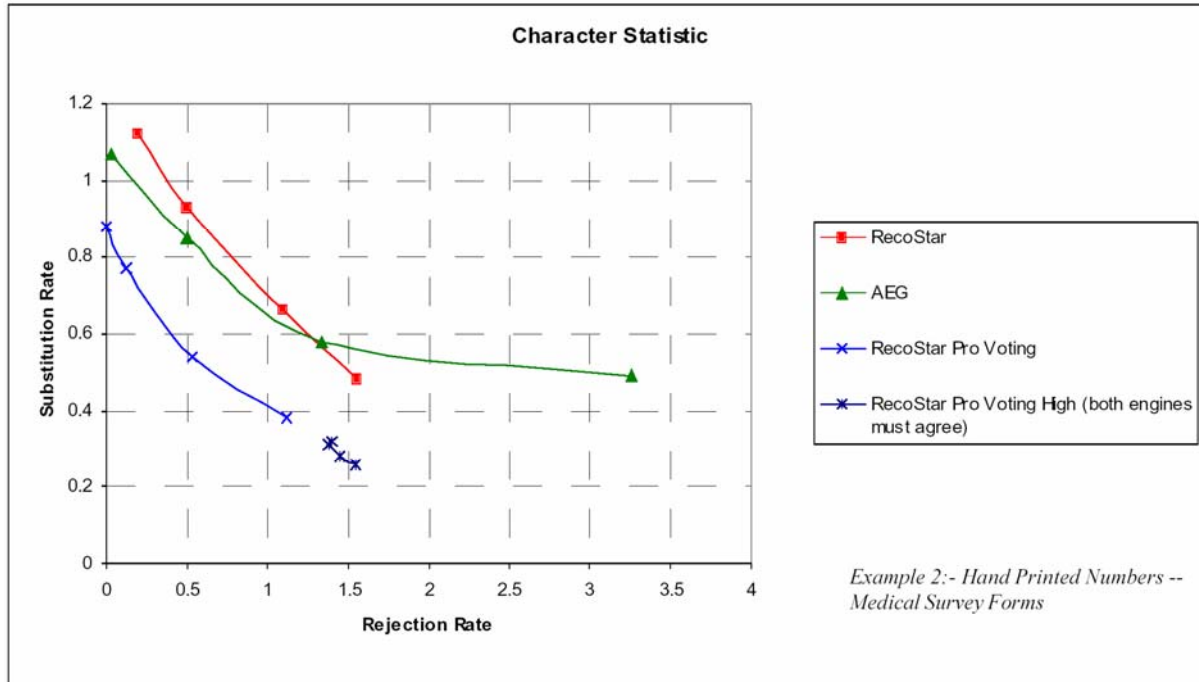

Legend:

Substitution Rate (SR):

Percentage of all characters with confidence levels above acceptance threshold but wrongly recognized. It is also known as “false positive rate” or error rate. This percentage determines the quality of an OCR engine as these results cannot be corrected unless some data validation rules are applied.

Rejection Rate (RR):

Percentage of all characters with confidence levels below acceptance threshold regardless whether the result is correct or incorrect. These characters are usually displayed on a keying station for verification.

Accuracy Rate (AR):

Percentage of all characters with confidence levels above acceptance threshold and correctly recognized. This percentage rate is only implied and has to be determined by the formula as follows:

$$AR = 100 \% - SR - RR$$

How to read the charts:

The charts on the previous pages show real life examples of single engines and voting.

In the application shown in Example 1, the single engine AEG recognizes 98.15% of the data correctly. The substitution rate is 0.85% with a rejection rate of 1%. The single RecoStar engine has a accuracy rate of 98.25%, substitution rate of 0.75% and the same rejection rate of 1%.

Using the voting engine RecoStar Pro with the same rejection rate of 1%, the substitution rate drops to 0.4%. In other words, the error rate has been cut by half.

If the error rate of the single engine is acceptable, the voting engine can be used to reduce the rejection rate. Consider the following as shown on Page 12. At 1% rejection rate, AEG has an error rate of 0.85%. Recognizing the same application with the voting engine and keeping the same error rate of 0.85%, the rejection rate drops from 1% down to 0.25%. In other words, the amount of data to be keyed or to be verified by a data entry person will be cut by 75%.

FOR IMMEDIATE RELEASE:

State of Rhode Island Judiciary Selects Intellidact

ORLANDO, Fla. (May, 2013) – Computing System Innovations (CSI), America's leading provider of unstructured data recognition solutions, is pleased to announce that the Rhode Island Judiciary has awarded CSI its automated data extraction project. Rhode Island represents CSI's fourth statewide client for Intellidact.

The Intellidact solution's sophisticated intelligence properly classifies documents and identifies fields required for indexing. Four advanced character-recognition engines (i.e., machine, handprint, MICR, and cursive script) locate and vote on data eligible for automatic redaction and/or indexing. Intellidact provides high volume, high speed, high accuracy unstructured data recognition technology to rapidly locate and reliably capture metadata within any PDF, TIFF, Microsoft Office, JPEG or GIF image file, decreasing the amount of time needed to manually data entry.

"We are pleased to partner with the Rhode Island Judiciary to process their important data recognition project," said Henry Sal, President of CSI. "We look forward to working with the Judiciary to roll out this statewide solution."

"We were looking for a vendor that had proven experience with statewide implementations; after a thorough competitive evaluation it was clear CSI was our best choice," said Peter Panciocco, Rhode Island Supreme Court's executive director and member of the state's courts executive committee and vendor evaluation team. "Intellidact's large network of successful users will provide Rhode Island a valuable resource, and we plan to leverage their best practices and apply those lessons to our new business processes."

CSI recognized the need for automated data extraction technology in the early 2000s. In response, CSI created Intellidact and processed many successful automated indexing projects. Intellidact continues to lead the industry, providing the most cost-effective, high volume, high accuracy indexing solution with the least amount of manual verification required.

CSI has proven experience in rapid, accurate indexing processing and validation of large quantities of documents for Local and State Government Agencies. Intellidact has been selected for use in enterprise-scale indexing projects across the United States. Using Intellidact, CSI has processed more than 2.75 Billion images for over 230 customers in 21 states.

About Computing System Innovations

Computing System Innovations (CSI) is a privately held corporation with headquarters in Central Florida, and maintains research and development facilities in Austin, Texas and Irvine, California. In business for 27 plus years, CSI is a proven and well-balanced software company, delivering solutions to corporate enterprises and government institutions. Customers range from Fortune 500 companies to state and local governments. CSI's commercial applications division is the leading provider of automated redaction, and auto docketing/indexing technology in the United States. CSI technology empowers public and private entities to deal with both privacy of data and increases in document volume issues as part of normal document processing workflow. If you would like more information about CSI's Identity Theft protection technology, please visit www.csisoft.com or www.intellidact.com.

For further information contact:
Victor Lee
Computing System Innovations
(407) 598-1825
vlee@csisoft.com



FOR IMMEDIATE RELEASE:

Washington State awards Privacy Protection Project to CSI

ORLANDO, Fla. (May, 2013) – Computing System Innovations (CSI), America's leading provider of intelligent redaction solutions, is pleased to announce that the Washington State Department of Licensing (DOL) has awarded CSI its Uniform Commercial Code Program privacy protection project. The Department of Licensing provides information to law enforcement, licenses and regulates drivers, registers vehicles and vessels, and manages over 44 professional and business licensing programs.

Intellidact solution's sophisticated intelligence properly classifies documents and identifies fields containing sensitive information. Four advanced character-recognition engines (i.e., machine, handprint, MICR, and cursive script) locate and vote on data eligible for automatic redaction and/or indexing. Intellidact does not alter the original document. Instead, Intellidact creates a redacted version of the original document, which can be saved into an image repository. Intellidact provides high volume, high speed, high accuracy unstructured data recognition technology to rapidly locate and reliably redact confidential information within any PDF, TIFF, Microsoft Office, JPEG or GIF image file, decreasing the amount of time needed to comply with information privacy legislation.

"We are pleased to have won the Washington State competition and be able to assist them with their important privacy protection project," said Henry Sal, President of CSI. "We look forward to working with the state as additional needs to protect information are recognized."

CSI recognized the alarmingly increasing problem of Identity Theft crimes in the early 2000s. In response, CSI created Intellidact and processed America's first successful automated redaction project in 2004. Intellidact continues to lead the industry, providing the most cost-effective, high volume, high accuracy redaction solution with the least amount of manual verification required.

CSI has proven experience in rapid, accurate redaction processing and validation of large quantities of documents for Local and State Government Agencies. Intellidact has been selected for use in enterprise-scale redaction projects across the United States. Using Intellidact, CSI has redacted more than 2.75 Billion images for over 230 customers in 21 states.

About Computing System Innovations

Computing System Innovations (CSI) is a privately held corporation with headquarters in Central Florida, and maintains research and development facilities in Austin, Texas and Irvine, California. In business for 20 plus years, CSI is a proven and well-balanced software company, delivering solutions to corporate enterprises and government institutions. Customers range from Fortune 500 companies to state and local governments. CSI's commercial applications division is the leading provider of automated redaction, and auto docketing/indexing technology in the United States. CSI technology empowers public and private entities to deal with both privacy of data and increases in document volume issues as part of normal document processing workflow. If you would like more information about CSI's Identity Theft protection technology, please visit www.csisoft.com or www.intellidact.com.

For further information contact:
Victor Lee
Computing System Innovations
(407) 598-1825
vlee@csisoft.com



FOR IMMEDIATE RELEASE:

Miami Dade County Courts Award CSI with Privacy Protection Project

ORLANDO, Fla. (May, 2013) – Computing System Innovations (CSI), America's leading provider of intelligent redaction solutions, is pleased to announce that the Miami Dade Clerk and Comptroller has awarded its privacy protection project to CSI. The Miami Dade Clerk's office will use CSI's redaction software, Intellidact®, to automatically remove sensitive identity information from both e-filed as well as traditionally filed court documents. Intellidact will provide identity theft protections for residents in the county and allow the Clerk's office to achieve compliance with the Sunshine State's document privacy requirements as court records are made Internet accessible.

The Intellidact solution's sophisticated intelligence properly classifies documents and identifies fields containing sensitive information. Four advanced character-recognition engines (i.e., machine, handprint, MICR, and cursive script) locate and vote on data eligible for automatic redaction and/or indexing. Intellidact does not alter the original document. Instead, Intellidact creates a redacted version of the original document, which can be saved into an image repository or delivered to an e-recording or e-filing system. Intellidact provides high volume, high speed, high accuracy unstructured data recognition technology to rapidly locate and reliably redact confidential information within any PDF, TIFF, Microsoft Office, JPEG or GIF image file, decreasing the amount of time needed to comply with information privacy legislation.

"We are honored to have been selected by the Clerk to assist with this important privacy protection project," said Henry Sal, President of CSI. "We look forward to working to provide privacy protections now for their important court documents as well."

"Having the largest repository of documents in the state, we turned to CSI as our redaction partner," said Harvey Ruvin, Clerk and Comptroller of Miami Dade County. "Having experience with Intellidact on our land records, we turned again to CSI for protecting our court documents. We found Intellidact extremely accurate in removal of privacy information on both land record and court documents."

CSI recognized the alarmingly increasing problem of Identity Theft crimes in the early 2000s. In response, CSI created Intellidact and processed America's first successful automated redaction project in 2004. Intellidact continues to lead the industry, providing the most cost-effective, high volume, high accuracy redaction solution with the least amount of manual verification required.

CSI has proven experience in rapid, accurate redaction processing and validation of large quantities of documents for Local and State Government Agencies. Intellidact has been selected for use in enterprise-scale redaction projects across the United States. Using Intellidact, CSI has redacted more than 2.75 Billion images for over 230 customers in 21 states

About Computing System Innovations

Computing System Innovations (CSI) is a privately held corporation with headquarters in Central Florida, and maintains research and development facilities in Austin, Texas and Irvine, California. In business for 20 plus years, CSI is a proven and well-balanced software company, delivering solutions to corporate enterprises and government institutions. Customers range from Fortune 500 companies to state and local governments. CSI's commercial applications division is the leading provider of automated redaction, and auto docketing/indexing technology in the United States. CSI technology empowers public and private entities to deal with both privacy of data and increases in document volume issues as part of normal document processing workflow. If you would like more information about CSI's Identity Theft protection technology, please visit www.csisoft.com or www.intellidact.com.

For further information contact:
Victor Lee
Computing System Innovations
(407) 598-1825
vlee@csisoft.com



FOR IMMEDIATE RELEASE:

Clutch Group Selects Intellidact for JP Morgan Chase

ORLANDO, Fla. (October 2012) - Computing System Innovations the leader in unstructured data recognition, and Clutch Group, a global leader in delivering legal and compliance solutions, today announced a partnership to apply Intellidact technology to Governance, Risk, Compliance (GRC) and eDiscovery markets. This integrated partnership combines Intellidact's advanced recognition technology and Clutch Group's innovative processing to replace the analysis of 1300 unique data points for JP Morgan Chase.

Clutch Group is recognized as one of the most innovative and capable providers of eDiscovery and risk/compliance services. "The combination of Clutch Group's award-winning services and subject matter expertise along with Intellidact's unique, advanced unstructured data capture platform will provide our mutual clients with unparalleled solutions to some of their most vexing challenges," said Glen Johnson, Executive Vice President of Technology at CSI.

The partnership is the result of a series of projects where Clutch conducted a side-by-side comparison of various tools available to the legal and compliance market. In contrast to the other unstructured data recognition tools available in the legal market, Intellidact drove extraordinary value and results across actual data sets.

"After extensive testing and analysis, we have been working closely with CSI to help clients improve accuracy and efficiency in processing of big data." said JB Costilow, Vice President at Clutch Group.

About Clutch Group

Clutch Group is a global, enterprise-class organization dedicated to providing professional services for law. Founded in 2005 by top attorneys from leading firms and business process pioneers, Clutch Group has grown to over 450 legal, technology and process experts in 5 offices across 3 continents.

Clutch was built from the ground up to help General Counsels more effectively manage problems within Fortune 500 companies. At our core, we have built expertise in harnessing technology, implementing process and focusing on Fact Development across our organization to deliver a risk-measured, cost optimized solution for our clients. Our clients consist of leading corporations' legal and compliance departments and our services are tailored to the core industry verticals in which we operate, including Financial Services, Life Sciences and Technology companies.

Clutch Group has been consistently ranked as a top provider by industry research as well as client satisfaction since its inception and has been recognized by industry authorities including Chambers Global, Frost & Sullivan, the Black Book of Outsourcing and Dun & Bradstreet. For more information, go to <http://www.clutchgroup.com>.

About Computing System Innovations

Computing System Innovations (CSI) is a privately held corporation with headquarters in Central Florida, and maintains research and development facilities in Austin, Texas and Irvine, California. In business for 20 plus years, CSI is a proven and well-balanced software company, delivering solutions to corporate enterprises and government institutions. Customers range from Fortune 500 companies to state and local governments. CSI's commercial applications division is the leading provider of automated redaction, and auto docketing/indexing technology in the United States. CSI technology empowers public and private entities to deal with both privacy of data and increases in document volume issues as part of normal document processing workflow. If you would like more information about CSI's Identity Theft protection technology, please visit www.csisoft.com or www.intellidact.com.

For further information contact:
Victor Lee
Computing System Innovations
(407) 598-1825
vlee@csisoft.com



FOR IMMEDIATE RELEASE:



Computing System Innovations Continues to Climb in Inc. 5000 Rankings for 2012

Orlando, FL (October 5, 2012)—Computing System Innovations (CSI), America's leading provider of intelligent redaction solutions, announced that Inc. Magazine has awarded the company a prestigious Inc. 5000 rating for the third consecutive year. The award recognizes the fastest-growing private companies in the United States. The company ranked 3,919 in 2010, and in two years has moved up to position 1,560, representing a 190% growth in revenue. CSI ranks 28th overall in the security industry space.

According to CSI president Henry Sal, the award is a testimony to how growth-oriented entrepreneurial firms like CSI and others on the list can thrive in today's volatile economy.

"I am extremely pleased to receive this prestigious award for the third year in a row," Sal said. By offering industry-leading solutions that solve tough business challenges, we continue to see increasing demand for our products and services. Receiving this award for a third year, again, validates our expert staff and their dedication to providing leading technologies in the redaction market space," Sal explained. "It also confirms the fact that private entrepreneurial businesses are today, and always will be, the lifeblood of the U.S. economy."

The award was presented at the annual conference and ceremony October 3-5, 2012 in Phoenix, AZ. The 3-day event, attracted nearly 2000 attendees, featured some of the country's most prominent business executives and authorities on leadership.

Complete results of the Inc. 5000 can be found at www.inc.com/5000, with CSI's Inc. 5000 listing located at www.inc.com/inc5000/profile/computing-system-innovations

About the Inc.500/5000 & Inc. Magazine

The Inc.500/5000 is an annual list of the 5000 fastest-growing privately-owned companies in the United States as determined by Inc. Magazine. The publication, Founded in 1979, is the only major business magazine dedicated exclusively to owners and managers of growing private companies.

About Computing System Innovations

Based in the Central Florida's high-tech corridor, Computing System Innovations (CSI) produces the highest accuracy automated redaction software in the world. The company's flagship product, Intellidact, is a suite of software solutions designed to empower governments, municipalities and private businesses to effectively manage the complexity of identity theft and data privacy in a climate of increased document volumes, as well as regulatory and budget pressures. The most widely-used redaction software in the country, Intellidact solutions protect the identities of 1 in 5 people in the United States.

For further information contact:
Victor Lee
Computing System Innovations
(407) 598-1825
vlee@csisoft.com



FOR IMMEDIATE RELEASE

CSI's IntelliDact® Redaction Solution Continues to Raise the Bar

CSI Introduces "Future Proofing™" to Secure Privacy Information Now and for the Future

ORLANDO, Fla. (June 9, 2008) – Computing System Innovations (CSI), America's leading provider of automated redaction software, is pleased to announce introduction of "Future Proofing™" technology within its award winning IntelliDact redaction software suite. CSI's future proofing technology allows customers to perform one time processing for all potential identity theft and privacy information fields, immediately produce redacted images containing only current mandates, and reuse initial processing results to produce images with additional redactions as requirements change in the future without additional costs.

When new legislation mandates the redaction of limited fields (such as social security numbers) from images, agencies are wary of effecting immediate protection on public records due to concern over reprocessing the records when additional fields are identified and mandated. IntelliDact's Future Proof™ technology allows for immediate protection with redaction of an initial set of mandated information (e.g., Social Security Numbers), and then through IntelliDact's forward thinking design, redaction of any set of additional fields from the images without incurring lengthy or costly reprocessing. Some common "identifying information" that may need to be removed from documents at a later date include: Drivers License Numbers, Dates of Birth, Addresses, Maiden Names, Minor Children Names/Ages, PINs, Signatures, and Bank/Credit/Debit Account Numbers.

IntelliDact® combines sophisticated algorithms with twenty man-years of development to properly classify documents and identify fields of interest. Three advanced character-recognition engines (i.e., machine, hand print, and cursive script) locate and vote on data eligible for IntelliDact to redact and/or index without user intervention. After processing, a "clean redacted" document is created and saved into an image repository or delivered to an e-recording or e-filing system. IntelliDact® provides high volume, high speed, high accuracy unstructured data recognition technology to rapidly locate and reliably redact confidential information within any PDF, TIFF, or GIF image file, decreasing the amount of time to comply with information privacy legislation.

"CSI is pleased to introduce Future Proofing technology to the redaction market. Such innovation continues to further CSI's leading position in providing software solutions to the redaction challenges customers face," said Henry Sal, President of CSI. "Although I expect the technology to be copied over time and become part of standard offerings, being first does have its benefits."

CSI, with early recognition of the widespread problem of identity theft, created IntelliDact® and processed America's first successful automated redaction project in 2004. IntelliDact® continues to lead this industry, processing both the largest and fastest automated redaction projects in the nation to date. By creating value for customers with new developments such as "future proofing", CSI continues to be 'the yardstick by which others measure'.

IntelliDact® has been selected for use in enterprise scale redaction projects including the Clerks of Court for Miami-Dade, Broward, Palm Beach, Marion, Lake, Citrus, Flagler, Martin, Osceola and Polk Counties in Florida; the Secretaries of State for Missouri, Colorado, Arizona, and North Carolina; the Clerk of Court for Travis County, Texas; the Bernalillo County Metropolitan Court in New Mexico; and the Commonwealth of Virginia.

About Computing System Innovations

Computing System Innovations (CSI) is a privately held corporation with headquarters in Central Florida, and maintains research and development facilities in Austin, Texas; Irvine, California. In business for 20 plus years, CSI is a proven and well-balanced based software company, delivering solutions to corporate enterprises and government institutions. Customers range from Fortune 500 companies to state and local governments. CSI's



commercial applications division is the leading provider of automated redaction, and auto docketing/indexing technology in the United States. CSI's IntelliDact[®] technology has redacted over **3/4** billion images to date. CSI technology empowers public and private entities to deal with both privacy of data and increases in document volume issues as part of normal document processing workflow. If you would like more information about CSI's Identity Theft protection technology, please visit www.csisoft.com.

Charisse Hernandez
Computing System Innovations
(407) 598-1812
chernandez@csisoft.com
www.csisoft.com



FOR IMMEDIATE RELEASE:

3D Redaction™ Significant Increase to Processing Accuracy

ORLANDO, Fla. (February, 2011) – Computing System Innovations (CSI), America's leading provider of intelligent redaction software, Intellidact®, announced today 3D Redaction. 3D Redaction redefines redaction processing as a three-dimensional process by combining automated processing, manual verification, along with software analytics and redaction enforcement to significantly increase redaction accuracy.

Current automated redaction is a two dimensional process consisting of automated processing using pre-defined "rules" to locate privacy information on images, coupled with manual verification of either all processed images, or hybrid verification of images having low processing confidence. 3D Redaction provides the additional needed dimension of protection using advanced software analytics applied to processed documents. 3D Redaction automatically catches and corrects mistakes made in the initial automated image processing and subsequent manual verification stages that occur with standard two dimensional processing.

"3D Redaction processing is like having yet another set of eyes review each and every processed document, however these eyes belong to Superman, have x-ray vision, never blink, and never make a mistake," said Henry Sal, President of CSI. "We are amazed at the amount of privacy information hidden on documents that 3D Redaction software catches automatically."

CSI recognized the alarmingly increasing problem of Identity Theft crimes in the early 2000s. In response, CSI created Intellidact and processed America's first successful automated redaction project in 2004. Intellidact continues to lead the industry, providing the most cost-effective, high volume, high accuracy redaction solution with the least amount of manual verification required.

Intellidact provides load balanced grid processing with four advanced data recognition engines (ICR, OCR, MICR, and computerized vision) working in harmony to locate information eligible for automatic redaction, replacement, or data capture. Intellidact provides high volume, high speed, high accuracy unstructured data recognition technology to rapidly locate and reliably redact or replace confidential information within any XML, PDF, TIFF, Microsoft Office, JPEG or GIF image file, decreasing the amount of time needed to comply with information privacy compliance.

CSI has proven experience in rapid, accurate redaction processing and validation of large quantities of documents within the public and private sector. Intellidact has been selected for use in enterprise-scale redaction projects across the United States and has processed in excess of 2 billion pages for hundreds of diverse customers since its inception.

About Computing System Innovations

Computing System Innovations (CSI) is a privately held corporation with headquarters in Central Florida, and maintains research and development facilities in Austin, Texas. CSI's commercial applications division is America's leading provider of automated redaction and automated data capture technology. CSI is a 2010 recipient of the prestigious INC 5000 award and one of the 5000 fastest growing companies in America. CSI technology empowers public and private entities to deal with both privacy of data and increases in document volume issues as part of normal document processing workflow. If you would like more information about CSI's Identity Theft protection technology, please visit www.intellidact.com.

For further information contact:
Victor Lee
Computing System Innovations
(407) 598-1825
vlee@csisoft.com



FOR IMMEDIATE RELEASE:

Intellidact Wins First Three California Redaction RFPs

CSI's Intellidact® proven superior with three out of three wins

ORLANDO, Fla. (March 13, 2009) – Computing System Innovations (CSI), America's leading provider of intelligent redaction solutions, announced it has performed a clean sweep of the first three California counties having issued RFPs to satisfy AB 1168 truncation requirements. Sacramento, San Diego, and now Sonoma County have all elected to award their critical identity theft protection projects to CSI's award winning Intellidact technology.

Intellidact® employs sophisticated intelligence to properly classify documents and identify fields of interest. Four advanced character-recognition engines (i.e., machine, handprint, MICR, and cursive script) locate and vote on data eligible for Intellidact to redact and/or index without user intervention. After processing, a "clean" document is created and saved into an image repository or delivered to an e-recording or e-filing system. Intellidact provides high volume, high speed, high accuracy unstructured data recognition technology to rapidly locate and reliably redact confidential information within any PDF, TIFF, Microsoft Office, or GIF image file, decreasing the amount of time to comply with information privacy legislation.

"We are very pleased that in open competition, Intellidact has been selected not by one, but by the first, second, and third California Counties having issued RFPs to acquire redaction technology", said Henry Sal, President of CSI. "Such awards show that when Intellidact is allowed to compete, Intellidact is the technology to beat".

CSI, with early recognition of the widespread problem of Identity Theft, created Intellidact and processed America's first successful automated redaction project in 2004. Intellidact continues to lead the industry, providing the most cost-effective, high volume, high accuracy redaction solution with the least amount of manual verification required.

CSI has proven experience in rapid, accurate redaction processing and validation of large quantities of documents for Local and State Government Agencies. Intellidact has been selected for use in enterprise scale redaction projects including the Clerk of Courts for Miami-Dade, Palm Beach, Marion, Lake, Citrus, Flagler, Martin, Osceola and Polk Counties in Florida; the Clerk of Courts for Arlington and Alexandria Counties in Virginia; the Secretary of States for Missouri, Colorado, Arizona, and North Carolina; the Clerk of Court for Travis County, Texas; the Bernalillo County Metropolitan Court in New Mexico; and the Supreme Court of Virginia. To date, CSI customers in over 15 states have processed more than 1.4 Billion images for redaction using Intellidact.

About Computing System Innovations

Computing System Innovations (CSI) is a privately held corporation with headquarters in Central Florida, and maintains research and development facilities in Austin, Texas and Irvine, California. In business for 20 plus years, CSI is a proven and well-balanced software company, delivering solutions to corporate enterprises and government institutions. Customers range from Fortune 500 companies to state and local governments. CSI's commercial applications division is the leading provider of automated redaction, and auto docketing/indexing technology in the United States. CSI technology empowers public and private entities to deal with both privacy of data and increases in document volume issues as part of normal document processing workflow. If you would like more information about CSI's Identity Theft protection technology, please visit www.csisoft.com or www.intellidact.com.

For further information contact:
Charisse Hernandez
Computing System Innovations
(407) 598-1812
chernandez@csisoft.com



FOR IMMEDIATE RELEASE:

Intellidact wins first California RFP with superior redaction accuracy

ORLANDO, Fla. (September 15th, 2008) – Computing System Innovations (CSI), America's leading provider of intelligent redaction solutions, announced it has been selected by Sacramento County in their national RFP process to provide redaction software and services to the county recorder's office for compliance to California assembly bill 1168. CSI is the only vendor to have received perfect scores in accuracy for offsite processing and validation of documents, in the onsite accuracy challenge of processing customer documents in real time, and in ease of use.

Intellidact® employs sophisticated intelligence to properly classify documents and identify fields of interest. Four advanced character-recognition engines (i.e. machine, hand, MICR, and cursive script) locate and vote on data eligible for Intellidact to redact and/or index without user intervention. After processing, a "clean" document is created and saved into an image repository or delivered to an e-recording or e-filing system. Intellidact provides high volume, high speed, high accuracy unstructured data recognition technology to rapidly locate and reliably redact confidential information within any PDF, TIFF, or GIF image file decreasing the amount of time to comply with information privacy legislation.

"We are excited about winning the first redaction RFP in California. Our margin of victory once again proves that in head to head competition, Intellidact continues to be the superior redaction solution on the market" said Henry Sal, President of CSI. "With all the software manufacturers competing, our scores clearly prove that Intellidact is the highest accuracy solution and the easiest to use. We look forward to working with Sacramento County to protect the identity of their citizens far in advance of California bill 1168 deadlines".

CSI, with early recognition of the widespread problem of Identity Theft, created Intellidact and processed America's first successful automated redaction project in 2004. Intellidact continues to lead this industry processing both the largest and fastest automated redaction projects in the nation to date. CSI has proven experience in rapid, accurate redaction processing and validation of large quantities of documents for Local and State Government Agencies. Intellidact has been selected for use in enterprise scale redaction projects including the Clerk of Courts for Miami-Dade, Palm Beach, Marion, Lake, Citrus, Flagler, Martin, Osceola and Polk Counties in Florida; the Secretary of States for Missouri, Colorado, Arizona, and North Carolina; the Clerk of Court for Travis County, Texas; the Bernalillo County Metropolitan Court in New Mexico; the Supreme Court of Virginia and 70 counties within the Commonwealth, and the County Clerk and Records office in Nashville Tennessee. To date, CSI customers have processed more than one billion images for redaction using Intellidact.

About Computing System Innovations

Computing System Innovations (CSI) is a privately held corporation with headquarters in Central Florida, and maintains research and development facilities in Austin, Texas and Irvine, California. In business for 20 plus years, CSI is a proven and well-balanced software company, delivering solutions to corporate enterprises and government institutions. Customers range from Fortune 500 companies to state and local governments. CSI's commercial applications division is the leading provider of automated redaction, and auto docketing/indexing technology in the United States. CSI technology empowers public and private entities to deal with both privacy of data and increases in document volume issues as part of normal document processing workflow. If you would like more information about CSI's Identity Theft protection technology, please visit www.csisoft.com or www.intellidact.com.

For further information contact:
Charisse Hernandez
Computing System Innovations
(407) 598-1812
chernandez@csisoft.com



FOR IMMEDIATE RELEASE:

State of Iowa Selects Intellidact for Redaction

CSI's Intellidact® clear choice in national search

ORLANDO, Fla. (June 1st, 2009) – Computing System Innovations (CSI), America's leading provider of intelligent redaction solutions, announced it has been selected by the Iowa County Recorders Association to provide redaction software and services to protect the citizens of Iowa by processing land record images from 99 counties and 6 different land record system vendors within the state.

Intellidact® employs sophisticated intelligence to properly classify documents and identify fields of interest. Four advanced character-recognition engines (i.e., machine, handprint, MICR, and cursive script) locate and vote on data eligible for Intellidact to redact and/or index without user intervention. After processing, a "clean" document is created and saved into an image repository or delivered to an e-recording or e-filing system. Intellidact provides high volume, high speed, high accuracy unstructured data recognition technology to rapidly locate and reliably redact confidential information within any PDF, TIFF, Microsoft Office, or GIF image file, decreasing the amount of time to comply with information privacy legislation.

"We are honored to be selected by Iowa for their important statewide land records redaction project," said Henry Sal, President of CSI. "Our proposal received the highest rating in all evaluation categories including best overall value and cost effectiveness."

CSI, with early recognition of the widespread problem of Identity Theft, created Intellidact and processed America's first successful automated redaction project in 2004. Intellidact continues to lead the industry, providing the most cost-effective, high volume, high accuracy redaction solution with the least amount of manual verification required.

CSI has proven experience in rapid, accurate redaction processing and validation of large quantities of documents for Local and State Government Agencies. Intellidact has been selected for use in enterprise scale redaction projects including the Clerk of Courts for Miami-Dade, Palm Beach, Marion, Lake, Citrus, Flagler, Martin, Osceola and Polk Counties in Florida; San Diego, Sacramento and Sonoma counties in California; the Clerk of Courts for Arlington and Alexandria Counties in Virginia; the Secretary of States for Missouri, Colorado, Arizona, and North Carolina; the Clerk of Court for Davidson County (Nashville), Tennessee; the Clerk of Court for Travis County (Austin), Texas; the Bernalillo County (Albuquerque) Metropolitan Court in New Mexico; and the Supreme Court of Virginia. To date, CSI customers in over 15 states have processed more than 1.4 Billion images for redaction using Intellidact.

About Computing System Innovations

Computing System Innovations (CSI) is a privately held corporation with headquarters in Central Florida, and maintains research and development facilities in Austin, Texas and Irvine, California. In business for 20 plus years, CSI is a proven and well-balanced software company, delivering solutions to corporate enterprises and government institutions. Customers range from Fortune 500 companies to state and local governments. CSI's commercial applications division is the leading provider of automated redaction, and auto docketing/indexing technology in the United States. CSI technology empowers public and private entities to deal with both privacy of data and increases in document volume issues as part of normal document processing workflow. If you would like more information about CSI's Identity Theft protection technology, please visit www.csisoft.com or www.intellidact.com.

For further information contact:
Charisse Hernandez
Computing System Innovations
(407) 598-1812
chernandez@csisoft.com



FOR IMMEDIATE RELEASE:

Supreme Court of Virginia Awards Redaction Technology Contract to CSI

CSI Provides Industry Proven Solution for Commonwealth of Virginia

ORLANDO, Fla. (March 4, 2008) – Computing System Innovations (CSI), America's leading provider of intelligent redaction solutions is pleased to announce that it has been selected to provide redaction processing technology for the Commonwealth of Virginia. The Virginia Supreme Court award encompasses processing for approximately 70 Virginia Clerk Courts with 40 million existing documents and 8 million new additions each year.

IntelliDact®, CSI's award winning technology will be utilized to remove social security numbers from electronic land and court records displayed and maintained by the Supreme Court of Virginia. Pursuant to Code of Virginia §17.1-279, circuit court clerks must provide secure remote access to land records on or before July 1, 2008. CSI will provide IntelliDact technology and services to assist in preventing these public documents from becoming a source of identity theft. In addition to redaction, CSI's IntelliDact® will provide automatic indexing of new documents as they are scanned, reducing data entry requirements while increasing accuracy.

IntelliDact® employs sophisticated intelligence to properly classify documents and identify fields of interest. Three advanced character-recognition engines (i.e. machine, hand and voting) locate and vote on data eligible for IntelliDact to redact and/or index without user intervention. After processing, a "clean" document is created and saved into an image repository or delivered to an e-recording or e-filing system. IntelliDact® provides high volume, high speed, high accuracy unstructured data recognition technology to rapidly locate and reliably redact confidential information within any PDF, TIFF, or GIF image file decreasing the amount of time to comply with information privacy legislation.

"CSI is pleased to have IntelliDact selected by the Virginia Supreme Court as the winner of their national selection process. Such an award affirms IntelliDact as the leader in public records protection software within the United States", said Henry Sal, President of CSI. "IntelliDact continues to offer the most cost-effective, high-volume, high accuracy redaction solution with the least amount of manual verification required, irrespective of document contents and formats."

CSI, with early recognition of the widespread problem of Identity Theft created IntelliDact® and processed America's first successful automated redaction project in 2004. IntelliDact® continues to lead this industry processing both the largest and fastest automated redaction projects in the nation to date.

About Computing System Innovations

Computing System Innovations (CSI) is a privately held corporation with headquarters in Central Florida, and maintains research and development facilities in Austin, Texas and Irvine, California. In business for 20 plus years, CSI is a proven and well-balanced software company, delivering solutions to corporate enterprises and government institutions. Customers range from Fortune 500 companies to state and local governments. CSI's commercial applications division is the leading provider of automated redaction, and auto docketing/indexing technology in the United States. CSI technology empowers public and private entities to deal with both privacy of data and increases in document volume issues as part of normal document processing workflow. If you would like more information about CSI's Identity Theft protection technology, please visit www.csisoft.com or www.intellidact.com.

For further information contact:
Charisse Hernandez
Computing System Innovations
(407) 598-1812
chernandez@csisoft.com



FOR IMMEDIATE RELEASE:

Twelve Florida Counties Choose CSI to Help Protect the Private Information of Their Citizens

CSI's Intellidact® Tackles Large Scale Redaction Projects

ORLANDO, Fla. (February 2011) – Computing System Innovations (CSI), America's leading provider of intelligent redaction solutions, announced twelve of the largest Florida Counties have selected CSI's automated redaction solution, Intellidact®, which provides automated redaction and indexing functionality for official records and court systems.

CSI offered Broward, Citrus, Flagler, Lake, Marion, Martin, Miami-Dade, Osceola, Palm Beach, Pinellas, Polk, and Seminole counties an efficient business solution for the automated redaction of private documents. Intellidact® employs sophisticated intelligence to properly classify documents and identify fields of interest. Three advanced character-recognition engines (i.e. machine, hand and voting) locate and vote on data eligible for Intellidact to redact and/or index without user intervention. After processing, a "clean" document is created and saved into an image repository or delivered to an e-recording or e-filing system. Intellidact® provides high volume, high speed, high accuracy unstructured data recognition technology to rapidly locate and reliably redact confidential information within any PDF, TIFF, or GIF image file decreasing the amount of time to comply with information privacy legislation.

"We are excited about the opportunity to provide these twelve counties with an integrated effort for dealing with the growing issue of identity theft and fraud," said Henry Sal, President of CSI. "CSI's intelligent redaction technology, Intellidact®, is a paradigm shift away from existing processes. We offer a complete solution that not only helps organizations deal effectively and efficiently with redaction requirements, but also uses the technology to create added benefits. I guess you could say we have a 'think outside the box' approach to redaction."

CSI, with early recognition of the widespread problem of Identity Theft, created Intellidact® and processed America's first successful automated redaction project in 2004. Intellidact® continues to lead this industry processing both the largest and fastest automated redaction projects in the nation to date.

CSI has proven experience in rapid, accurate redaction processing and validation of large quantities of documents for Local and State Government Agencies. Intellidact® has been selected for use in enterprise scale redaction projects including the Clerk of Courts for Miami-Dade, Broward, Palm Beach, Pinellas, Seminole, Marion, Lake, Citrus, Flagler, Martin, Osceola and Polk Counties in Florida; the Secretaries of State for Missouri, Colorado, Arizona, and North Carolina; the State of Iowa; the Clerk of Court for Travis County, Texas; the Bernalillo County Metropolitan Court in New Mexico; and the Supreme Court of Virginia. To date, CSI customers have processed more than 2 billion images for redaction using Intellidact®.

About Computing System Innovations

Computing System Innovations (CSI) is a privately held corporation with headquarters in Central Florida, and maintains research and development facilities in Austin, Texas. In business for 26 years, CSI is a proven and well-balanced software company, delivering solutions to corporate enterprises and government institutions. Customers range from Fortune 500 companies to state and local governments. CSI's commercial applications division is the leading provider of automated redaction, and auto docketing/indexing technology in the United States. CSI technology empowers public and private entities to deal with both privacy of data and increases in document volume issues as part of normal document processing workflow. If you would like more information about CSI's Identity Theft protection technology, please visit www.csisoft.com or www.intellidact.com.

For further information contact:
Victor Lee
Computing System Innovations
(407) 598-1825
vlee@csisoft.com



FOR IMMEDIATE RELEASE:

Wisconsin Counties Select Intellidact®

ORLANDO, Fla. (May 2011) – Computing System Innovations (CSI) – America’s leading provider of intelligent redaction solutions – announced today that eight Wisconsin Counties have selected CSI’s automated redaction solution, Intellidact®, to provide critical identity theft protection for their public records.

After careful and independent research, *Adams, Burnett, Jackson, Outagamie, Polk, Rusk, Vernon* and *Waushara* counties have selected Intellidact as the most efficient solution for automated removal of privacy information from their public records. Intellidact, through use of advanced character and graphic recognition engines (machine, handprint, and unique computerized vision), locates and “votes” on sensitive data that is eligible for automatic removal or replacement. The system then creates and stores a clean copy of the original document, having privacy information permanently removed.

Intellidact provides high-volume, high-speed, high-accuracy unstructured data recognition to rapidly locate and reliably remove confidential information, decreasing the amount of time needed to achieve information privacy compliance. Intellidact processes PDF, TIFF, JPG, GIF, XML and Microsoft Office documents. Regardless of where privacy information appears, or whether it was handwritten or machine-printed, Intellidact accurately eliminates would-be identity thieves’ access to the sensitive data.

“Wisconsin is the 21st state where Intellidact has been deployed. Intellidact now protects one out of every five Americans in the United States from identity theft,” said Henry Sal, president of CSI. “We look forward to continuing to provide simple and flexible redaction solutions and identity theft protection throughout the United States.”

To assist in the prevention of identity theft, CSI created Intellidact and processed America’s first automated removal of personally identifiable information from electronic public records in 2004. Intellidact technology has since processed more than 2 billion pages in 21 different states, providing customers with the most comprehensive set of sensitive data removal capabilities for their digital documents.

Intellidact continues to lead the industry, providing the most cost-effective, high-volume, high-accuracy solution, with the least amount of manual verification required.

About Computing System Innovations

Computing System Innovations (CSI) is a privately held corporation with headquarters in Central Florida, and maintains research and development facilities in Austin, Texas. CSI’s commercial applications division is the leading provider of automated data redaction and capture technology in the United States.

CSI technology empowers public and private organizations to deal with both privacy of data and increases in document volume issues as part of normal document processing workflow. If you would like more information about CSI’s Identity Theft protection technology, please visit www.intellidact.com.

For more information, contact:
Victor Lee
Computing System Innovations
(407) 598-1825
vlee@csisoft.com



FOR IMMEDIATE RELEASE:

Intellidact redaction technology now integrated with HP commercial printing and imaging products

ORLANDO, Fla. (April 25, 2011) – Computing System Innovations (CSI), America's leading provider of intelligent redaction software, Intellidact[®], announces today that Intellidact is now available for use within HP LaserJet printers, Multifunction products and Scanjet scanners.

The Intellidact solution's sophisticated intelligence properly classifies documents and identifies fields containing sensitive information. Advanced character and graphic recognition engines (i.e., machine, handprint, and computerized vision) locate and vote on data eligible for automatic redaction or replacement. Intellidact does not alter the original document. Instead, Intellidact creates a sanitized version of the original document, which can be saved into an image repository or delivered to an e-recording or e-filing system. Intellidact provides high volume, high speed, high accuracy unstructured data recognition technology to rapidly locate and reliably remove confidential information within any PDF, TIFF, Microsoft Office, JPEG or GIF image file, decreasing the amount of time needed to comply with information privacy compliance.

"We are pleased to have been recognized by HP for our award winning automated redaction and document privacy compliance technology," said Henry Sal, President of CSI. "HP is a leading technology company, we are of course excited with the ability to provide Intellidact with HP document capture solutions."

To assist in the prevention of identity theft, CSI created Intellidact and processed America's first automated removal of personal identifiable information from electronic public records in 2004. Intellidact technology has since processed over 2 billion images in 21 different states, providing customers the most thorough and extensive set of sensitive data removal capabilities for their digital documents.

"Our commercial LaserJet and Scanjet customers are seeking integrated printing and imaging solutions that are reliable, protect sensitive enterprise data, and keep compliance intact," said John Johasky, Vice President and General Manager, Managed Enterprise Solutions, Imaging and Printing Group, HP. "Our partnership with CSI allows us to meet these needs."

Intellidact continues to lead the industry, providing the most cost-effective, high-volume, high accuracy solution with the least amount of manual verification required.

About Computing System Innovations

Computing System Innovations (CSI) is a privately held corporation with headquarters in Central Florida, and maintains research and development facilities in Austin, Texas. CSI's commercial applications division is the leading provider of automated redaction, and automated indexing technology in the United States. CSI technology empowers public and private entities to deal with both privacy of data and increases in document volume issues as part of normal document processing workflow. If you would like more information about CSI's Identity Theft protection technology, please visit www.intellidact.com.

For further information contact:
Victor Lee
Computing System Innovations
(407) 598-1825
vlee@csisoft.com



FOR IMMEDIATE RELEASE:

Intellidact Enterprise Redaction Software Microsoft Certified for SharePoint

ORLANDO, Fla. (February, 2011) – Computing System Innovations (CSI), America's leading provider of intelligent redaction and data capture software, Intellidact®, announces that Intellidact has been Microsoft certified for SharePoint 2010.

Intellidact for SharePoint provides Intellidact's leading identity theft protections and automated data capture technologies engineered to work seamlessly within SharePoint environments. Intellidact for SharePoint can process documents either as they are being added to a SharePoint repository, or on demand for documents that already exist. Intellidact for Sharepoint is the first enterprise class automated document redaction solution to achieve Microsoft SharePoint 2010 platform certification.

Intellidact provides load balanced grid processing with four advanced character recognition engines (ICR, OCR, MICR, and computerized vision) working in harmony to locate data eligible for automatic redaction, replacement, or data capture. Intellidact does not alter original documents, instead, Intellidact creates a completely sanitized version of the document which along with the original is automatically indexed and saved within SharePoint. Intellidact provides high volume, high speed, high accuracy unstructured data recognition technology to rapidly locate and reliably redact or replace confidential information within any PDF, TIFF, Microsoft Office, JPEG or GIF image file, decreasing the amount of time needed to comply with information privacy compliance.

"SharePoint is an integral part of our enterprise redaction platform strategies. We are pleased to be the first enterprise class redaction solution to have achieved Microsoft SharePoint certification," said Henry Sal, President of CSI. "We look forward to SharePoint's continued growth and playing an important part in providing identity theft and document privacy compliance solutions within it."

CSI recognized the alarmingly increasing problem of Identity Theft crimes in the early 2000s. In response, CSI created Intellidact and processed America's first successful automated redaction project in 2004. Intellidact continues to lead the industry, providing the most cost-effective, high volume, high accuracy redaction solution with the least amount of manual verification required.

CSI has proven experience in rapid, accurate redaction processing and validation of large quantities of documents within the public and private sector. Intellidact has been selected for use in enterprise-scale redaction projects across the United States and has processed in excess of 2 billion documents for hundreds of diverse customers since its inception.

About Computing System Innovations

Computing System Innovations (CSI) is a privately held corporation with headquarters in Central Florida, and maintains research and development facilities in Austin, Texas. CSI's commercial applications division is the leading provider of automated redaction, and automated data capture technology in the United States. CSI technology empowers public and private entities to deal with both privacy of data and increases in document volume issues as part of normal document processing workflow. If you would like more information about CSI's Identity Theft protection technology, please visit www.intellidact.com.

For further information contact:
Victor Lee
Computing System Innovations
(407) 598-1825
vlee@csisoft.com



FOR IMMEDIATE RELEASE:

A Matter of Privacy in Pinellas County

ORLANDO, Fla. (August 2011) – Computing System Innovations (CSI) announced it's been awarded the job of protecting privacy information on court documents in Pinellas County Florida. The Pinellas Clerk's office will use CSI's redaction software, Intellidact®, to automatically remove sensitive identity information from both e-filed as well as traditionally filed court documents. Intellidact will provide identity theft protections for the over 900,000 residents in the county and allow the Clerk's office to achieve compliance with the Sunshine State's document privacy requirements well in advance of the upcoming 2012 deadline.

"We are pleased to have been selected by the Clerk's office in their important privacy protection project," said Henry Sal, President of CSI. "Intellidact will be used to provide both redaction of privacy information and automated data capture with the Clerk's existing Global 360 and new Tyler Odyssey case management systems."

Intellidact rapidly locates and accurately redacts sensitive information from any PDF, TIFF, XML, MS Office, JPEG, or GIF file. Intellidact's unstructured data recognition technology locates and redacts both machine and handprint information anywhere within a document. Upon location of sensitive data, Intellidact creates a sanitized copy of the original document, or can provide redaction zone coordinates for image masking in "on demand" processing environments. Used to process over 2 billion images in 21 states, Intellidact includes extensive out of the box definitions of PII, PCI, FSS 119.07 and Judicial Rule 2.420 confidential data elements.

"We view CSI as a technology partner for our office," said Ken Burke, Clerk and Comptroller of Pinellas County. "In our selection process we benchmarked Intellidact on 3.5 million probate court records against technology used for our land records. We found Intellidact was significantly more accurate in removal of privacy information on our court documents."

In addition to redaction, Intellidact will provide automated data capture and real time document classification for the Clerk's office. Document classification is determined by the contents of a document, and for court documents, Intellidact automatically calculates the correct Odyssey docket code and workflows. Intellidact provides validation of the extracted data and located redaction zones in a unified interface that combines previously separate data entry and redaction review processes into a single step to accelerate document processing workflows.

About Computing System Innovations

Computing System Innovations produces the highest accuracy automated redaction software in the world. CSI leads the redaction software industry with Intellidact's EyeSight™ and 3D Redaction™ technology while protecting customer investments with Intellidact Future Proofing™. CSI's recent introduction of Intellidact's Case Stateful™ and Learn By Example™ functionality is defining the future of court document redaction and automatic docketing processing.

Intellidact is a registered trademark of Computing System Innovations. Global 360 is a trademark of OpenText Corporation. Odyssey is a trademark of Tyler Technologies.

For further information contact:
Victor Lee
Computing System Innovations
(407) 598-1825
vlee@csisoft.com



FOR IMMEDIATE RELEASE:

Computing System Innovations announces the Florida Association of Court Clerks (FACC) has selected CSI's Intellidact for its courts document redaction technology solution

ORLANDO, Fla. (December, 2010) – Computing System Innovations (CSI), America's leading provider of intelligent redaction solutions, is pleased to announce that FACC has selected CSI's Intellidact for its redaction technology solution. FACC will be offering Intellidact technology to provide advanced privacy protection for its customers.

The Intellidact solution's sophisticated intelligence properly classifies documents and identifies fields containing sensitive information. Four advanced character-recognition engines (i.e., machine, handprint, MICR, and cursive script) locate and vote on data eligible for automatic redaction and/or indexing. Intellidact does not alter the original document. Instead, Intellidact creates a redacted version of the original document, which can be saved into an image repository or delivered to an e-recording or e-filing system. Intellidact provides high volume, high speed, high accuracy unstructured data recognition technology to rapidly locate and reliably redact confidential information within any PDF, TIFF, Microsoft Office, JPEG or GIF image file, decreasing the amount of time needed to comply with information privacy legislation.

"CSI is pleased to have been selected by FACC as its privacy protection redaction partner," states Henry Sal, President of CSI. "We look forward to working with FACC to provide a proven and seamless solution for their Florida customers' redaction, extraction, and e-filing needs as well as protecting their redaction investments with our FutureProof™ and EyeSight™ technologies."

"FACC is excited to leverage CSI's powerful redaction solutions to further complement our Clericus software. With this partnership, we're bringing CSI's leadership in automated redaction and extraction together to complement our Clericus solution offerings. Introducing this solution is a natural extension of our strategy which only enhances the E-Portal and Clericus experience for customers by helping clerks perform their duties faster and more accurately. We have worked with CSI previously through other projects and their sophisticated redaction engines have proven outstanding. We are excited to announce this offering to our clients," Melvin Cox, FACC Director of Technology, stated.

CSI has proven experience in rapid, accurate redaction processing and validation of large quantities of documents for Local and State Government Agencies. Intellidact has been selected for use in enterprise-scale redaction projects across the United States. Since 2004, Intellidact has been used to redact more than 1.9 Billion images for over 200 customers in 18 states.

About Computing System Innovations

Computing System Innovations (CSI) is a privately held corporation with headquarters in Central Florida, and maintains research and development facilities in Austin, Texas and Irvine, California. CSI's commercial applications division is the leading provider of automated redaction, and auto docketing/indexing technology in the United States. CSI technology empowers public and private entities to deal with both privacy of data and increases in document volume issues as part of normal document processing workflow. If you would like more information about CSI's Identity Theft protection technology, please visit www.csisoft.com or www.intellidact.com.

About FACC, Inc.

The Florida Association of Court Clerks and Comptrollers, established in 1969, is a statewide, non-profit member association. The Association is comprised of the Florida Clerks of the Circuit Court and Comptrollers. The Association provides education and accreditation for Clerks of the Court and Comptrollers, information and technical assistance to local governments.

For further information contact:
Victor Lee
Computing System Innovations
(407) 598-1825
vlee@csisoft.com

Melvin Cox
Florida Association of Court Clerks
(850)921-0808
cox@flclerks.com



FOR IMMEDIATE RELEASE:

Vernon County Wisconsin Register of Deeds Selects Intellidact for Privacy Protection

ORLANDO, Fla. (June, 2010) – Computing System Innovations (CSI), America's leading provider of intelligent redaction solutions, is pleased to announce that the Register of Deeds office in Vernon County Wisconsin has selected Intellidact® for its critical redaction project. The Register's office records, protects, preserves, and reproduces legal documents related to real estate transactions for Vernon County's 29,000 residents. Intellidact has been selected by the Register to provide compliance with 2009 Wisconsin Act 314. The Register of Deeds office will perform its privacy protection project using CSI Intellidact intelligent redaction technology to process both existing and newly filed images at CSI's secure data center.

The Intellidact solution's sophisticated intelligence properly classifies documents and identifies fields containing sensitive information. Four advanced character-recognition engines (i.e., machine, handprint, MICR, and cursive script) locate and vote on data eligible for automatic redaction and/or indexing. Intellidact does not alter the original document. Instead, Intellidact creates a redacted version of the original document, which can be saved into an image repository or delivered to an e-recording or e-filing system. Intellidact provides high volume, high speed, high accuracy unstructured data recognition technology to rapidly locate and reliably redact confidential information within any PDF, TIFF, Microsoft Office, JPEG or GIF image file, decreasing the amount of time needed to comply with information privacy legislation.

"We are honored to have been selected by the Register of Deeds to assist with their important privacy protection project," said Henry Sal, President of CSI. "We look forward to working with Vernon County in providing compliance with their redaction of social security numbers. Our FutureProof™ technology will be used to protect their investment by Intellidact processing all identity theft information allowing additional identity theft redaction requirements to be satisfied without additional cost."

"I am looking forward to working with CSI for our social security number redaction project," said Konna Spaeth, Vernon County Register of Deeds. "They have been wonderful to work with in the beginning stages of the process and in answering all of my questions. I have been extremely impressed with their staff and am anxious to get started with the project."

CSI recognized the alarmingly increasing problem of Identity Theft crimes in the early 2000s. In response, CSI created Intellidact and processed America's first successful automated redaction project in 2004. Intellidact continues to lead the industry, providing the most cost-effective, high volume, high accuracy redaction solution with the least amount of manual verification required.

CSI has proven experience in rapid, accurate redaction processing and validation of large quantities of documents for Local and State Government Agencies. Intellidact has been selected for use in enterprise-scale redaction projects across the United States. Using Intellidact, CSI has redacted more than 1.75 Billion images for over 200 customers in 18 states.

About Computing System Innovations

Computing System Innovations (CSI) is a privately held corporation with headquarters in Central Florida, and maintains research and development facilities in Austin, Texas and Irvine, California. In business for 20 plus years, CSI is a proven and well-balanced software company, delivering solutions to corporate enterprises and government institutions. Customers range from Fortune 500 companies to state and local governments. CSI's commercial applications division is the leading provider of automated redaction, and auto docketing/indexing technology in the United States. CSI technology empowers public and private entities to deal with both privacy of data and increases in document volume issues as part of normal document processing workflow. If you would like more information about CSI's Identity Theft protection technology, please visit www.csisoft.com or www.intellidact.com.

For further information contact:
Jeff Miller
Computing System Innovations
(407) 598-1826
jmiller@csisoft.com



FOR IMMEDIATE RELEASE:

Jefferson County Kentucky Clerk Selects Intellidact for Critical Privacy Protection

ORLANDO, Fla. (August 23, 2010) – Computing System Innovations (CSI), America's leading provider of intelligent redaction solutions, is pleased to announce that the Jefferson County Clerk's office in Louisville Kentucky has selected Intellidact® for its important redaction processing project. Intellidact will be used by the Clerk's office to remove sensitive information from their document recordings of real estate transactions and will interface with the Clerk's Kofax Capture and ACS land records system to provide a seamless privacy protection solution. Intellidact will be used to process and sanitize one million newly recorded pages per year as well as the existing fifteen million pages within their document repository. The Clerk's investment in redaction processing will be protected by Intellidact's FutureProof™ and Eyesight™ technology.

The Intellidact solution's sophisticated intelligence properly classifies documents and identifies fields containing sensitive information. Advanced character and graphic recognition engines (i.e., machine, handprint, MICR, and Computerized Vision) locate and vote on data eligible for automatic redaction and/or indexing. Intellidact does not alter the original document. Instead, Intellidact creates a redacted version of the original document, which can be saved into an image repository or delivered to an e-recording or e-filing system. Intellidact provides high volume, high speed, high accuracy unstructured data recognition technology to rapidly locate and reliably redact confidential information within any PDF, TIFF, Microsoft Office, JPEG or GIF image file, decreasing the amount of time needed to comply with information privacy legislation.

"We are pleased to have been selected by the Clerk's office as the their technology partner in their important privacy protection project," said Henry Sal, President of CSI. "With Jefferson County being our initial Intellidact customer in Kentucky, our dedicated team of experts is excited to get to work and exceed their expectations. We look forward to working with the Clerk's organization in providing the very best value in redaction processing and protecting their citizens privacy."

CSI recognized the alarmingly increasing problem of Identity Theft crimes in the early 2000s. In response, CSI created Intellidact and processed America's first successful automated redaction project in 2004. Intellidact continues to lead the industry, providing the most cost-effective, high volume, high accuracy redaction solution with the least amount of manual verification required.

CSI has proven experience in rapid, accurate redaction processing and validation of large quantities of documents for Local and State Government Agencies. Intellidact has been selected for use in enterprise-scale redaction projects across the United States. Using Intellidact, CSI has redacted more than 1.92 Billion images for over 200 customers in 18 states.

About Computing System Innovations

Computing System Innovations (CSI) is a privately held corporation with headquarters in Central Florida, and maintains research and development facilities in Austin, Texas. In business for 20 plus years, CSI is a proven and well-balanced software company, delivering solutions to corporate enterprises and government institutions. Customers range from Fortune 500 companies to state and local governments. CSI's commercial applications division is the leading provider of automated redaction, and auto docketing/indexing technology in the United States. CSI technology empowers public and private entities to deal with both privacy of data and increases in document volume issues as part of normal document processing workflow. If you would like more information about CSI's Identity Theft protection technology, please visit www.csisoft.com or www.intellidact.com.

For further information contact:
Jeff Miller
Computing System Innovations
(407) 598-1826
jmiller@csisoft.com



FOR IMMEDIATE RELEASE:

Centre County Recorder Completes Privacy Protection Project

ORLANDO, Fla. (March, 2010) – Computing System Innovations (CSI), America's leading provider of intelligent redaction solutions, is pleased to announce that the Recorder of Deeds office in Centre County Pennsylvania has successfully completed its land records privacy protection project. The Recorders office records, protects, preserves, and reproduces legal documents related to real estate transactions for Centre County's 150,000 residents. The Recorders office completed their privacy protection project using CSI Intellidact® intelligent redaction technology to process its three million land record images at CSI's secure data center.

The Intellidact solution's sophisticated intelligence properly classifies documents and identifies fields containing sensitive information. Four advanced character-recognition engines (i.e., machine, handprint, MICR, and cursive script) locate and vote on data eligible for automatic redaction and/or indexing. Intellidact does not alter the original document. Instead, Intellidact creates a redacted version of the original document, which can be saved into an image repository or delivered to an e-recording or e-filing system. Intellidact provides high volume, high speed, high accuracy unstructured data recognition technology to rapidly locate and reliably redact confidential information within any PDF, TIFF, Microsoft Office, JPEG or GIF image file, decreasing the amount of time needed to comply with information privacy legislation.

"We are honored to have been selected by the Recorder to assist with this important privacy protection project," said Henry Sal, President of CSI. "We look forward to working with Centre County as additional needs to protect information are recognized."

Joe Davidson, Centre County Recorder of Deeds, states "There is evidence to suggest that some criminals from around America and other countries are turning to public records to obtain private information that is available on line. Social Security numbers are the primary tool for stealing someone's identity. These numbers are used to unlock bank accounts and credit cards. We are fortunate at Centre County we had the resources to be able to partner with CSI, one of the most experienced vendors and a leader in the document redaction business, to help us reduce this threat for Centre County property owners". Joe Davidson also went on to say "The current PA Open Records Law doesn't require the Recorder of Deeds to redact sensitive information from public records on line, but if the resources are available it's the responsible thing to do. As an elected official I feel protecting our residents identity should be one of the priorities of this office."

CSI recognized the alarmingly increasing problem of Identity Theft crimes in the early 2000s. In response, CSI created Intellidact and processed America's first successful automated redaction project in 2004. Intellidact continues to lead the industry, providing the most cost-effective, high volume, high accuracy redaction solution with the least amount of manual verification required.

CSI has proven experience in rapid, accurate redaction processing and validation of large quantities of documents for Local and State Government Agencies. Intellidact has been selected for use in enterprise-scale redaction projects across the United States. Using Intellidact, CSI has redacted more than 1.75 Billion images for over 200 customers in 18 states.

About Computing System Innovations

Computing System Innovations (CSI) is a privately held corporation with headquarters in Central Florida, and maintains research and development facilities in Austin, Texas and Irvine, California. In business for 20 plus years, CSI is a proven and well-balanced software company, delivering solutions to corporate enterprises and government institutions. Customers range from Fortune 500 companies to state and local governments. CSI's commercial applications division is the leading provider of automated redaction, and auto docketing/indexing technology in the United States. CSI technology empowers public and private entities to deal with both privacy of data and increases in document volume issues as part of normal document processing workflow. If you would like more information about CSI's Identity Theft protection technology, please visit www.csisoft.com or www.intellidact.com.

For further information contact:
Jeff Miller
Computing System Innovations
(407) 598-1826
jmiller@csisoft.com





CSI's IntelliDact[®] Recognized at AIIM Expo 2006 ***Solution to Prevent Identity Theft and Protect Privacy Garner Two First Place Awards***

ORLANDO, Fla. (July 11, 2006) - Computing System Innovations (CSI), a leading provider of redaction and unstructured data recognition with extraction, was recently honored with two first place awards at the AIIM (Association for Information and Image Management) Expo. The AIIM Expo 2006, held at the Pennsylvania Convention Center in Philadelphia, brought together leaders of the Information Management industry to demonstrate innovative and leading edge technologies.

At the AIIM Expo, CSI was pleased to demonstrate IntelliDact[®], a comprehensive automated redaction and unstructured data recognition solution that empowers government and private organizations with a method for sanitizing data. To date, CSI has been active in helping local government entities, particularly Clerk of Courts, remove private information from public documents. Millions of archived Legal Records and other electronic documents are available to the public, and thousands more are added every day. IntelliDact is CSI's solution for protecting private information within the contents of these documents.

IntelliDact employs sophisticated intelligence to properly identify documents and fields of interest. Advanced character recognition engines then locate and vote on data eligible for IntelliDact to index and/or redact. After processing, a "clean" document is created and saved into an image repository or delivered to e-recording or e-filing systems.

"CSI is honored to be recognized at AIIM for IntelliDact's innovative technology created to help organizations deal with the growing concern of identity theft and privacy. We look forward to continuing our leading efforts to produce solutions that both protect and expedite the flow of information," said Henry Sal, President of CSI.

The following items are excerpts from *Business Solutions* magazine and *Integrated Solutions* magazine respectively. These excerpts outline the awards received on behalf of CSI's IntelliDact solution.



2006 CHANNEL CONNECTION AWARD WINNERS ANNOUNCED
Business Solutions magazine recognizes top integrators for outstanding content management installations.

Winners of the seventh annual Channel Connection Awards were recognized at a special ceremony held at AIIM Expo 2006 at the Pennsylvania Convention Center in Philadelphia. Co-sponsored by Questex's AIIM Expo 2006 and *Business Solutions* magazine, the Channel Connection Awards recognize VARs and integrators for outstanding content management technology installations that demonstrate integration complexity and deliver ROI.

- ▶ **Computing System Innovation's (CSI) (Orlando, FL)** IntelliDact technology earned the **Innovative Government Technology Award** with its installation at the **Marion County Clerk of the Circuit Court**. The solution integrates Kofax Ascent Capture and Kofax VirtualReScan (VRS) with CSI's IntelliDact software, allowing the clerk's office to comply with a Florida state mandate to remove (or redact) sensitive information from all public records. The system allowed the clerk's office to sanitize with high accuracy seven million pages of official records in only seven weeks.



2006 I³ AWARD WINNERS ANNOUNCED

Integrated Solutions magazine recognizes outstanding content management installations.

Winners of the third annual I³ Awards were recognized at a special ceremony held at AIIM Expo 2006 at the Pennsylvania Convention Center in Philadelphia. Co-sponsored by Questex's AIIM Expo 2006 and *Integrated Solutions* magazine, the I³ Awards recognize end users for content management technology installations that are innovative, integrate multiple technologies, and inspire others.

- ▶ The **Marion County Clerk of the Circuit Court (Ocala, FL)** earned the **Innovative Compliance-Related Installation Award**. The Clerk's office integrated Kofax Ascent Capture with IntelliDact redaction software technology developed by **Computing System Innovations**, to comply with a Florida mandate to remove social security numbers, bank account numbers, credit card numbers, and other private information from all public records. The system allowed the Clerk's office to redact private information from seven million pages of official records in only seven weeks and is currently used to reduce the data entry from newly filed documents.

About *Business Solutions*

Business Solutions magazine is published exclusively for top management of companies that make up the distribution channel for information technology (IT) products. *Business Solutions'* articles show readers how to sell new technologies and penetrate growing vertical markets. *Business Solutions* provides "actionable information" for value-added resellers (VARs) and systems integrators to increase sales, improve profits, and trounce the competition.

About *Integrated Solutions*

Integrated Solutions magazine covers front end to back end enterprise integration and shows growing organizations how to capture, generate, and retrieve data at all points of work and service. The monthly publication educates IT decision makers about leading-edge technologies and applications that drive business performance – and revenue – by eliminating the boundaries of time, distance, and scale.

About Computing System Innovations

Computing System Innovations (CSI) is a privately owned and operated corporation with headquarters in Orlando, Florida, and a research and development office in Austin, Texas. In business for over 20 years, CSI is a mature and well-balanced open systems "solutions"-based company, serving the needs of both corporate and government institutions. Customers range from Fortune 500 companies to state and local government operations. Computing System Innovations' commercial applications division provides software solutions for automated redaction, unstructured data recognition with extraction, file tracking, document management, imaging, and workflow, along with enterprise integration of these technologies. For more information about CSI, please visit www.csisoft.com.

###

Charisse Hernandez
Computing System Innovations
(407) 598-1812
chernandez@csisoft.com

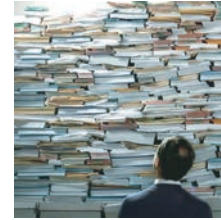
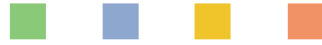

Intellidact® Intelligent Redaction Software

PRODUCT FEATURES:

- Automatic rules-based redaction
- Out of the box – greater than 99% accuracy, 15 ECM interfaces, 26 standard reports
- Future proofing™ technology
- Cursive script, handprint, and MICR redactions (absent machine print keywords)
- Dynamic Suggestion™ and QuickDraw™ validation
- Ultra high performance grid computing
- Comprehensive forensic audit trail

PRODUCT BENEFITS:

- Proven identity theft and fraud protection – over 1 billion images
- Highest industry accuracy with least amount of manual validation
- Removes human error and delays in creating public documents
- No time consuming knowledge base training
- Single in-house solution provides privacy compliance for archived and new documents
- Standards based interfaces to modern Land Records and Case Management systems

YOUR CHALLENGE

You're being asked to do more with less. You realize the benefits of providing public access to electronic records, but at the same time face the challenges of protecting private information within their contents. Identity theft and fraud are a thriving five billion dollar a year enterprise and you do not wish to be the source of information used to harm others. Even absent moratoriums and legislation, you realize an obligation to protect the privacy of information in your custody. What if the private information was yours? Surely you would want it removed.

Adding to your concerns, you face a daunting task. You have tens of millions of archived pages that need to be inspected and redacted. Daily processing of your new documents needs to be addressed as well. The courts and legislature have already realized the problem and you're waiting to see how any changes to regulations will affect you. You've considered outsourced labor to process the documents, but if the regulations change, your investment in redaction will be meaningless, and if you do nothing you'll leave your fellow neighbors and constituents unprotected.

OUR SOLUTION

CSI's intelligent redaction technology, Intellidact, is a paradigm shift away from existing processes. In fact, it's altering people's perception of redaction right before their very eyes. Intellidact's patent-pending technology automatically locates unstructured data anywhere in a document, redacting the specified data without human intervention.

The results are amazing. Intellidact can seamlessly process existing images in a repository, or be used as part of a scanning workflow, to rapidly and accurately accomplish an otherwise monumental task.

Intellidact employs sophisticated intelligence to properly identify documents and fields of interest consistently giving it the highest accuracy rating in the industry with the least amount of manual validation required. Advanced character recognition engines locate and vote on data eligible for Intellidact to redact. After processing, a "clean" document is created and saved into an image repository or delivered to your e-recording or e-filing systems. We're not talking about some future strategy. It's being done right now, and for pennies a page.

Before

IN THE CIRCUIT COURT OF THE TWELFTH JUDICIAL CIRCUIT IN AND FOR MARION COUNTY		CIVIL ACTION
THE STATE OF FLORIDA DEPARTMENT OF REVENUE, ON BEHALF OF:		
JANE DOE		
Petitioner/Plaintiff,		
vs.	CASE NO. 1996-DR-099916	
	IV-D AA	
JOHN DOE		
Respondent/Defendant.		
SSN: 123-45-6789		
STIPULATION FOR PATERNITY AND/OR SUPPORT		
The State of Florida, Department of Revenue on behalf of		
JANE DOE, Petitioner/Plaintiff, by and		
through its undersigned attorney, and the Respondent/Defendant,		
JOHN DOE, whose social security number is		
987-65-4321, agree to the following for the		
determination of paternity and/or child support obligation:		

After

IN THE CIRCUIT COURT OF THE TWELFTH JUDICIAL CIRCUIT IN AND FOR MARION COUNTY		CIVIL ACTION
THE STATE OF FLORIDA DEPARTMENT OF REVENUE, ON BEHALF OF:		
JANE DOE		
Petitioner/Plaintiff,		
vs.	CASE NO. 1996-DR-099916	
	IV-D AA	
JOHN DOE		
Respondent/Defendant.		
SSN: [REDACTED]		
STIPULATION FOR PATERNITY AND/OR SUPPORT		
The State of Florida, Department of Revenue on behalf of		
JANE DOE, Petitioner/Plaintiff, by and		
through its undersigned attorney, and the Respondent/Defendant,		
JOHN DOE, whose social security number is		
[REDACTED], agree to the following for the		
determination of paternity and/or child support obligation:		

HERE'S HOW IT WORKS

Intellidact analyzes document images obtained from TIFF or PDF files, e-mail attachments, database binary data, or web submissions. The images can come from existing data – your archived images – in addition to those originating from newly-scanned input.

CHARACTER RECOGNITION

The first step in Intellidact processing is for it to convert the image data to usable text. Intellidact includes four unique character recognition engines to convert image data. Optical character recognition (OCR) is used to convert machine print, while Intelligent character recognition (ICR) is used to convert handprint. A voting of the results from these two engines occurs to produce the most accurate rendition of text from image data. Next and if defined for processing, CSI invented MICR and cursive script engines identify and classify additional text which falls outside the realm of standard OCR/ICR engines giving Intellidact an unsurpassed ability to locate and redact all data found on documents using consistently performing software technology.

AUTOMATIC CLASSIFICATION

The next step in Intellidact processing is for Intellidact to classify the document. Intellidact works like a human, only much faster and with far fewer errors. Intellidact classification is accomplished based upon document content as well as information context. Classification allows Intellidact to determine for each individual document it processes, the correct document type, and apply any document specific rules for redaction. Such allows documents that are classified externally as one type, but contain sub documents of differing types, to have all their pages inspected and processed correctly.

REDACTION FIELD IDENTIFICATION

After classification determines the document type, the image is ready to be analyzed for “private” data. Intellidact uses sophisticated rules to locate fields and their values, based on text, labels, vertical and horizontal displacement, pattern recognition, phrase context, and dictionary lookups. For example, a simple rule could state that a Social Security number must be nine numbers, with or without hyphens, printed on either one line or split over a line break. It may appear after, above or below the text “SSN”. For your convenience, Intellidact includes pre-defined rules developed with over 20 man years of effort to provide the highest levels of document redaction accuracy to ensure compliance with existing privacy regulations.

VALIDATION

Intellidact provides for both manual and automatic validation. Manual processing allows an operator to validate the results of software redactions, while automatic processing occurs in the background based upon preset confidence levels. Intellidact’s manual validation program (“IntelliValidate”) includes several unique to CSI inventions, such as QuickDraw™ (point-and-click whole word redaction), Dynamic Suggestions™ (operator assistance for additional strings redacted), and global Find & Redact (by exact text or regular expressions) to minimize human error from Intellidact’s high volume validation process. Validation processing can either occur in band with your existing workflow requiring users to validate before any further stages of document processing, or out of band with Intellidact’s provided-for .NET workflow service.

AUTOMATIC QUALITY CONTROL

Sophisticated document confidence algorithms ensures data recognition as accurate; scoring below a user specified level flags the image for additional processing into one of Intellidact’s red, yellow, green or grey validation queues. If Automatic Quality Control detects low confidence, Intellidact forces the image to a Manual Validation queue for human-assisted processing.

AUTOMATIC REDACTION

Make no mistake about it, accurate redaction is the ultimate result of Intellidact processing. Every step leading up to the Redaction phase is in preparation for redacting confidential information in the document. After Redaction Field Identification locates a “private” field, if specified for processing, the Automatic Redaction alters the document image by writing a non-removable black rectangle over the data.

OUTPUT

Intellidact’s final step produces either TIFF or PDF documents sanitized of “private” information or the co-ordinates of the redaction field zones for consumption by upstream applications. Multiple output document versions may be created over time without lengthy processing using Intellidact’s Future Proofing™ technology to add additional redaction fields as identity theft schemes and legislation changes.

For additional information, contact:
Computing System Innovations
791 Piedmont Wekiwa Road
Apopka, FL 32703
Internet: <http://www.csisoft.com>
E-mail: info@csisoft.com
Phone: (877) 992-2900



© 2008 Computing System Innovations, Inc.
IntelliDact is a registered trademark of Computing System Innovations, Inc.
All other product names mentioned herein are trademarks or registered trademarks of their respective owners.

Exhibit E
Statement of Work
(to be attached one for each project)